

Detecting atoroidal 3-manifolds

Tsuyoshi KOBAYASHI 小 林 毅 (阪大・理)

1. Introduction.

Heegaard diagram of a closed 3-manifold ([4]) is one of the most fundamental description of the manifold. But it seems that little is known about it. For example, there is no efficient method to decide if the manifold with a given Heegaard diagram is aspherical or not. Recently, Casson-Gordon defined a generalized Heegaard diagram, and gave a criterion for the irreducibility of the Heegaard splitting ([2]). In fact, they showed that if a Heegaard splitting $(V_1, V_2; F)$ satisfies a certain condition, say a rectangle condition, and D_i ($\subset V_i$) ($i=1, 2$) is an essential disk, then $\partial D_1 \cap \partial D_2 \neq \emptyset$. This result together with the Haken's theorem ([3, 5]) and the Ochiai's theorem ([7]) implies that if a Heegaard splitting satisfies a rectangle condition, then the manifold is P^2 -irreducible. On the other hand, as the author observed in [6], a rectangle condition does not imply the non existence of an incompressible torus in the manifold. In this paper, we will define a strong version of a rectangle condition, say a strong rectangle condition, and show that if a Heegaard splitting satisfies a strong rectangle condition, then the manifold is geometrically atoroidal i.e. there is no incompressible torus in it (Corollary 1). Moreover, we will give a criterion for a hyperbolicity of a knot which can be embedded in a Heegaard surface of a 3-manifold (Theorem 2).

2. Strong rectangle condition.

Throughout this paper, we will work in the piecewise linear category. For the definitions of standard terms in the 3-dimensional topology, we refer to [4,5]. A surface (connected 2-manifold) properly embedded in a 3-manifold is essential if it is incompressible, and is not parallel to a subsurface of ∂M .

In this section, we will give the definition of a strong rectangle condition.

Let V be a handlebody with $\beta_1(V) = g > 1$, and D_1, \dots, D_{3g-3} be a system of mutually disjoint disks properly embedded in V such that $D_1 \cup \dots \cup D_{3g-3}$ cuts V into $2g-2$ solid pants Q_1, \dots, Q_{2g-2} i.e. $c\ell(V - N(D_1 \cup \dots \cup D_{3g-3})) = Q_1 \cup \dots \cup Q_{2g-2}$, and $Q_i \cap \partial V$ ($i=1, \dots, 2g-2$) is a disk with two holes, where $N(\)$ denotes a regular neighborhood. In this paper, we suppose that there are two different solid pants which intersect $N(D_i)$ for each i . We note that this condition is equivalent to:

Each D_i does not separate V into a genus one handlebody and a genus $g-1$ handlebody.

Let $\ell (C \partial V)$ be a simple loop. We say that ℓ is complicated with respect to D_1, \dots, D_{3g-3} (or simply complicated) if ℓ satisfies:

- (i) ℓ and $\partial D_1 \cup \dots \cup \partial D_{3g-3}$ are in general position in ∂V ,
- (ii) there is no 2-gon B in ∂V such that $\partial B = a \cup b$, where a is a subarc of ℓ , and b is a subarc of $\partial D_1 \cup \dots \cup \partial D_{3g-3}$,
- (iii) for each pair of boundary components of each pants $Q_i \cap \partial V$, there is a subarc a of ℓ properly embedded in $Q_i \cap \partial V$ such that a connects the boundary components.

Let R_i ($i=1, \dots, 3g-3$) be the solid double pants $P_{k_i} \cup N(D_i) \cup P_{\ell_i}$, where $P_{k_i} \cap N(D_i) \neq \emptyset$, $P_{\ell_i} \cap N(D_i) \neq \emptyset$. We note that $R_i \cap \partial V$ is a disk with three holes, and there are six ways of making pair of boundary components of $R_i \cap \partial V$. We say that ℓ is sufficiently complicated with respect to D_1, \dots, D_{3g-3} (or simply sufficiently complicated) if ℓ satisfies:

The above conditions (i), (ii), and

(iv) for each pair of boundary components of each double pants $R_i \cap \partial V$, there is a subarc a of ℓ properly embedded in $R_i \cap \partial V$ such that a connects the boundary components.

Then we have:

Lemma 2.1. If ℓ is sufficiently complicated with respect to D_1, \dots, D_{3g-3} , then ℓ is complicated with respect to D_1, \dots, D_{3g-3} .

Proof. Let P_i ($i=1, \dots, 2g-2$), R_j ($j=1, \dots, 3g-3$) be as above. Assume that ℓ is not complicated with respect to D_1, \dots, D_{3g-3} . Then there exists a solid pants P_k and a pair of boundary components m_1, m_2 of $P_k \cap \partial V$ such that no subarc of ℓ which is properly embedded in $P_k \cap \partial V$ connects m_1 and m_2 . Let D_s be the component of D_1, \dots, D_{3g-3} such that $N(D_s) \cap P_k \neq \emptyset$, and $m_1, m_2 \notin N(D_s)$, and P_t be the solid pants such that $P_t \neq P_k$, $P_t \cap N(D_s) \neq \emptyset$ i.e. $R_s = P_t \cup N(D_s) \cup P_k$. By the definition of the strong rectangle condition, there is a subarc a of ℓ which is properly embedded in $R_s \cap \partial V$, and connects m_1 and m_2 . Hence, there is a

subarc a'' of a' which is an essential arc properly embedded in $P_t \cap \partial V$ and connects one boundary component $N(D_s) \cap P_t \cap \partial V$. Let D_u be a disk such that $D_u \neq D_s$, and $N(D_u) \cap P_t \neq \emptyset$. Then, a'' separates $R_u \cap \partial V$ into an annulus and a pants. Hence, there is a pair of boundary components of $R_u \cap \partial V$ which are separated by a'' . But this contradicts the fact that ℓ is sufficiently complicated.

Let $(V_1, V_2: F)$ be a Heegaard splitting of a closed 3-manifold M i.e. V_i ($i=1,2$) is a handlebody, $M = V_1 \cup V_2$, and $V_1 \cap V_2 = \partial V_1 = \partial V_2 = F$. We say that $(V_1, V_2: F)$ satisfies a rectangle condition if there is a system of mutually disjoint disks $\{D_1, \dots, D_{3g-3}\}$ ($\{E_1, \dots, E_{3g-3}\}$ resp.) properly embedded in V_1 (V_2 resp.), which cuts V_1 (V_2 resp.) into solid pants Q_1, \dots, Q_{2g-2} (P_1, \dots, P_{2g-2} resp.) and satisfies:

(1) $\partial D_1 \cup \dots \cup \partial D_{3g-3}$ and $\partial E_1 \cup \dots \cup \partial E_{3g-3}$ are in general position,

(2) There is no 2-gon B in F such that $\partial B = a \cup b$, where a is a subarc of $\partial D_1 \cup \dots \cup \partial D_{3g-3}$, and b is a subarc of $\partial E_1 \cup \dots \cup \partial E_{3g-3}$,

(3) For each pair (Q_i, P_j) , we have:

For each pair of pair of boundary components $((\alpha, \beta), (\gamma, \delta))$ of $Q_i \cap F$ and $P_j \cap F$, there is a rectangle R in F such that R is embedded in $Q_i \cap F$, and $P_j \cap F$, and the edges of R are subarcs of α, β, γ , and δ .

We say that $(V_1, V_2; F)$ satisfies a strong rectangle condition if there is a system of disks $\{D_1, \dots, D_{3g-3}\}$ ($\{E_1, \dots, E_{3g-3}\}$ resp.) as above which satisfies:

The above conditions (1), (2), and

(4) Let R_i (S_i resp.) ($i=1, \dots, 3g-3$) be the solid double pants obtained from D_i (E_i resp.) as above. Then, for each pair (R_j, S_k) , we have:

For each pair of a pair of boundary components $((\alpha, \beta), (\gamma, \delta))$ of $R_j \cap F$ and $S_k \cap F$, there is a rectangle R in F such that R is embedded in $R_j \cap F$ and $S_k \cap F$, and the edges of R are subarcs of α, β, γ , and δ .

By using the arguments in the proof of Lemma 2.1. We can prove:

Lemma 2.2. If $(V_1, V_2; F)$ satisfies a strong rectangle condition, then it satisfies a rectangle condition. In fact, if two systems of disks in V_1, V_2 give a strong rectangle condition, then they also give a rectangle condition.

3. Theorem 1.

In this section, we will give a proof of the following theorem which is an analogy of a theorem of Casson-Gordon ([2]).

Theorem 1. Let $(V_1, V_2; F)$ be a Heegaard splitting of a closed 3-manifold, and A_i ($i=1,2$) be an essential annulus in V_i . If $(V_1, V_2; F)$ satisfies a strong rectangle condition, then $\partial A_1 \cap \partial A_2 \neq \emptyset$.

Proof. Let $\{D_1, \dots, D_{3g-3}\}, \{E_1, \dots, E_{3g-3}\}$ be systems of disks which give a strong rectangle condition of $(V_1, V_2; F)$. Let Q_1, \dots, Q_{2g-2} (P_1, \dots, P_{2g-2} resp.) be solid pants which are obtained from V_1 (V_2 resp.) ($i=1, \dots, 3g-3$) by cutting along $\cup D_i$ ($\cup E_i$ resp.). By general position arguments and cut and paste methods ([4]), we may suppose that $D_i \cap A_1$ ($E_i \cap A_2$ resp.) consists of (possibly empty) arcs properly embedded in D_i (E_i resp.). Moreover, we may suppose that each component of $\partial A_1 \cap (Q_i \cap F)$ ($\partial A_2 \cap (P_i \cap F)$ resp.) is an essential arc in $Q_i \cap F$ ($P_i \cap F$ resp.).

Suppose that there are components of $(\cup D_i) \cap A_1$, and $(\cup E_i) \cap A_2$ which are inessential arcs in A_1 , and A_2 . Then, by Lemma 2.2, and by the arguments in [2], we see that $\partial A_1 \cap \partial A_2 \neq \emptyset$. Hence, we may suppose that each component of $(\cup E_i) \cap A_2$ is an essential arc in A_2 .

By [1], we see that there is a train track τ on F such that ∂A_2 is carried by τ , and $\tau \cap (R_i \cap F), \tau \cap (N(E_i) \cap F)$ looks like as in Figure 1. Since each component of $A_2 \cap (\cup E_i)$ is an essential

arc in A_2 , we can isotope A_2 so that $\partial A_2 \subset N(\tau)$, and each component of $R_i \cap A_2$ looks like the bottom of a ditch (Figure 2).

Let D be a component of $N(E_i) \cap A_2$. We say that D is of type a if the components of $D \cap F$ (:two arcs) are carried by a path in $\tau \cap (N(D_i) \cap F)$, D is of type b if the components of $D \cap F$ are carried by pairwise different paths in $\tau \cap (N(D_i) \cap F)$ (Figure 3).

Assertion. There exists a component of $A_2 \cap (\cup N(D_i))$ which is of type b.

Proof. Assume that all components of $A_2 \cap (\cup N(D_i))$ are of type a. Then A_2 is parallel to an annulus in ∂V_2 , a contradiction.

We may suppose that $N(E_1) \cap A_2$ contains a type b disk D . Let S_1 be the solid double pants obtained from E_1 as in section 2, and D' be the component of $A_2 \cap S_1$ which contains D . Then $D' \cap F$ consists of two arcs a_1, a_2 properly embedded in $S_1 \cap F$. Since D is of type b, $a_1 \cup a_2$ separates two boundary components ℓ_1, ℓ_2 of $S_1 \cap F$ (Figure 4). Hence, if a is an arc properly embedded in $S_1 \cap F$, which connects ℓ_1 and ℓ_2 , then a intersects $a_1 \cup a_2$. Then, by the definition of strong rectangle condition, we see that a component ℓ of ∂A_2 ($\subset \partial V_1$) is sufficiently complicated with respect to D_1, \dots, D_{3g-3} . Now, we have the following two cases.

Case 1. There is a component a of $A_1 \cap (\cup D_i)$ which is an inessential arc in A_1 .

We may suppose that a is innermost i.e. there is a disk D in A_1 such that $cl(\partial D - \partial A_1) = a$, and $Int D \cap (\cup D_i) = \emptyset$. And we may suppose that $a \subset D_1$, $D \subset Q_1$. Since ℓ is complicated with respect to D_1, \dots, D_{3g-3} (Lemma 2.1), we see that $(\partial D - a) \cap \ell \neq \emptyset$. Hence, $\partial A_1 \cap \partial A_2 \neq \emptyset$.

Case 2. Every component of $A_1 \cap (\cup D_i)$ is an essential arc in A_1 .

In this case, by the arguments as above, we see that there is a solid double pants R obtained from D_i as in section 2, and there is a component E of $A_1 \cap R$ such that $E \cap F$ separates two boundary components m_1 and m_2 of $R \cap F$. Since ℓ is sufficiently complicated, there is a subarc b of ℓ properly embedded in $R \cap F$, which connects m_1 and m_2 . Hence, $\partial A_1 \cap \partial A_2 \neq \emptyset$.

This completes the proof of Theorem 1.

Corollary 1. If a Heegaard splitting of a closed 3-manifold satisfies a strong rectangle condition, then the manifold is geometrically atoroidal.

Proof. Let $(V_1, V_2; F)$ be a Heegaard splitting of a 3-manifold M , which satisfies a strong rectangle condition. Assume that M contains an incompressible torus T . By Lemma 2.2, and [6, Theorem 2], we may suppose that each component of $T \cap V_i$ ($i=1,2$) is an essential annulus in V_i . Hence, there are essential annuli A_1, A_2 in V_1, V_2 respectively such that $\partial A_1 \cap \partial A_2 = \emptyset$, a contradiction.

4. Detecting hyperbolic knots.

In this section, we will give a criterion to detect a given knot which is embedded in a Heegaard surface of a 3-manifold is hyperbolic.

Theorem 2. Let K be a knot embedded in the Heegaard surface of a Heegaard splitting $(V_1, V_2; F)$ of a closed orientable 3-manifold. Suppose that K is sufficiently complicated with respect to V_1 , and V_2 . Then K is a hyperbolic knot.

Lemma 4.1. Let V be a genus g (>1) handlebody, and ℓ ($\subset \partial V$) be a simple loop. If ℓ is complicated, then $cl(\partial V - N(\ell))$ is incompressible in V .

Proof. Assume that $cl(\partial V - N(\ell))$ is compressible in V , and let D be a compressing disk. Let D_1, \dots, D_{3g-3} be a system of disks in V such that ℓ is complicated with respect to D_1, \dots, D_{3g-3} . Then we may suppose that D intersects $D_1 \vee \dots \vee D_{3g-3}$ transversely and $D \cap (\cup D_i)$ consists of arcs properly embedded in D . Moreover, we may suppose that there is no 2-gon B in F such that $\partial B = a \vee b$, where a is a subarc of ∂D , and b is a subarc of $\partial D_1 \vee \dots \vee \partial D_{3g-3}$. Suppose that $D \cap (\cup D_i) = \emptyset$. Then D is parallel to some D_i . But this contradicts the fact that ℓ is complicated with respect to D_1, \dots, D_{3g-3} , and $\ell \cap \partial D = \emptyset$. Suppose that $D \cap (\cup D_i) \neq \emptyset$. Let C be a component of $D \cap (\cup D_i)$, which is innermost in D i.e. there is a disk D' in D such that

$cl(\partial D' - \partial D) = C$, and $Int D' \cap (\cup D_i) = \emptyset$. Let P be the closure of the component of $V - (\cup D_i)$ such that $D' \subset P$. Then, $cl(\partial D' - C)$ is an essential arc in $P \cap \partial V$. But this contradicts the fact that ℓ is complicated with respect to D_1, \dots, D_{3g-3} , and $\ell \cap \partial D = \emptyset$.

This completes the proof of Lemma 4.1.

The next lemma is proved implicitly in section 3. So, we will just see how the proof proceed.

Lemma 4.2. Let V, ℓ be as above. If ℓ is sufficiently complicated, then $(V, cl(\partial V - N(\ell)))$ is acylindrical i.e. if $(A, \partial A) \subset (V, cl(\partial V - N(\ell)))$ is an incompressible annulus, then A is parallel to an annulus in ∂V .

Outline of proof. Assume that there is an essential annulus A properly embedded in $(V, cl(\partial V - N(\ell)))$ such that A is not parallel to an annulus in ∂V . We may suppose that A and D_1, \dots, D_{3g-3} are in general position, and each component of $A \cap (\cup D_i)$ is an arc. Then, by the proof of Lemma 4.1, and 2.1, we see that each component of $A \cap (\cup D_i)$ is an essential arc in A . Then, by Assertion in section 3 we see that there is a solid double pants Q defined from D_1, \dots, D_{3g-3} such that a component of $A \cap Q$ separates a pair of boundary components of $Q \cap \partial V$, a contradiction.

As an immediate consequence of Lemma 4.2, we have:

Corollary 4.3. Let V, ℓ be as above. If ℓ is sufficiently complicated, then V is not homeomorphic to the total space of a $[0,1]$ bundle over a surface such that $c\ell(\partial V - N(\ell))$ corresponds to the associated $\{0,1\}$ bundle.

Proof of Theorem 2. First, we will show that the exterior of $K, Q(K)$, is geometrically atoroidal i.e. every incompressible torus in it is boundary parallel. Let T be an incompressible torus in $Q(K)$. Since $c\ell(F - N(K))$ is incompressible in $Q(K)$ (Lemma 4.1), and handlebodies are irreducible, we may suppose that T intersects $c\ell(F - N(K))$ transversely in essential loops. Moreover, we may suppose that the number of the components of $T \cap (c\ell(F - N(K)))$ is minimal among all surfaces which are ambient isotopic to T . By Lemma 4.2, we see that each component of $T \cap V_i$ is an annulus which is parallel to $N(K) \subset F$. Hence, T is parallel to $\partial Q(K)$.

Then we will show that $Q(K)$ does not admit a Seifert fibration. Assume that $Q(K)$ admits a Seifert fibration. Then, by Lemma 4.1, and [5, Theorem VI.34], we see that V_i is homeomorphic to the total space of a $[0,1]$ bundle over a surface, where $c\ell(\partial V - N(\ell))$ corresponds to the associated $\{0,1\}$ bundle, contradicting Corollary 4.3.

Hence, by Thurston [8], K is a hyperbolic knot.

This completes the proof of Theorem 2.

5. Examples.

In this section, we will give some examples. For the definition and properties of train tracks, see [1].

1. Let V be a genus 2 handlebody, and τ be the train track as in Figure 5. We note that τ is complete i.e. each component of $\partial V - \tau$ is a 3-gon. Hence τ defines an open set of the projective lamination space of ∂V ([1]). Let ℓ be a simple loop which is carried by τ with all weights are positive. Then it is easy to see that ℓ is sufficiently complicated with respect to D_1, D_2, D_3 . Let V' be a copy of V , and $h: \partial V \rightarrow \partial V'$ be the homeomorphism induced from the identification. Then $V \cup_h V'$ is homeomorphic to the connected sum of two $S^2 \times S^1$'s. Let $T_\ell: \partial V \rightarrow \partial V$ be the Dehn twist along ℓ . Then, by seeing the configuration of $T_\ell^n(\partial D_1 \cup \partial D_2 \cup \partial D_3)$ and $\partial D_1 \cup \partial D_2 \cup \partial D_3$ in $N(\ell)$, we see that the Heegaard splitting $(V, V'; F)$ of the manifold $V \cup_{h \circ T_\ell^n} V'$ satisfies a strong rectangle condition provided $|n|$ is sufficiently large. In fact, it is easily verified that if all the weights are greater than two, then $(V, V'; F)$ satisfies a strong rectangle condition provided $|n| \neq 0$.

2. Let $(V_1, V_2; F)$ be a genus two Heegaard splitting of S^3 . We draw a picture of F as in Figure 7. Let τ be the complete train track on F as in Figure 7, and $\{D_1, D_2, D_3\}$ ($\{D_1', D_2', D_3'\}$ resp.) be a system of disks in V_1 (V_2 resp.) as in Figure 7. Let ℓ be a simple loop which is carried by τ with all weights are positive. Then ℓ is sufficiently complicated with respect to D_1, D_2, D_3 and D_1', D_2', D_3' . Hence, by Theorem 2, ℓ is a hyperbolic knot.

References

- [1] A.J. Casson, Automorphisms of surfaces after Nielsen and Thurston, Lecture note, University of Texas (1982)
- [2] A.J. Casson, and C. McA. Gordon, Manifolds with irreducible Heegaard splittings of arbitrarily high genus, to appear
- [3] W. Haken , Some results on surfaces in 3-manifolds, Studies in Modern Topology, Math. Assoc. Amer., Prentice Hall, 1968
- [4] J. Hempel, 3-manifolds, Ann. of Math. Studies, 86, Princeton University Press, Princeton, N.J., 1976
- [5] W. Jaco, Lectures on three manifold topology, CBMS Regional Conference Series in Math. No 43, 1980
- [6] T. Kobayashi, Torus decompositions with tori intersecting Heegaard surfaces in essential loops, preprint
- [7] M. Ochiai, On Haken's theorem and its extension, Osaka J. Math. 20 (1983), 461-468
- [8] W. Thurston, Three dimensional manifolds, Kleinian groups and hyperbolic geometry, Bull. AMS 6(1982), 357-381

Department of Mathematics,
Osaka University,
Toyonaka, Osaka, 560
Japan

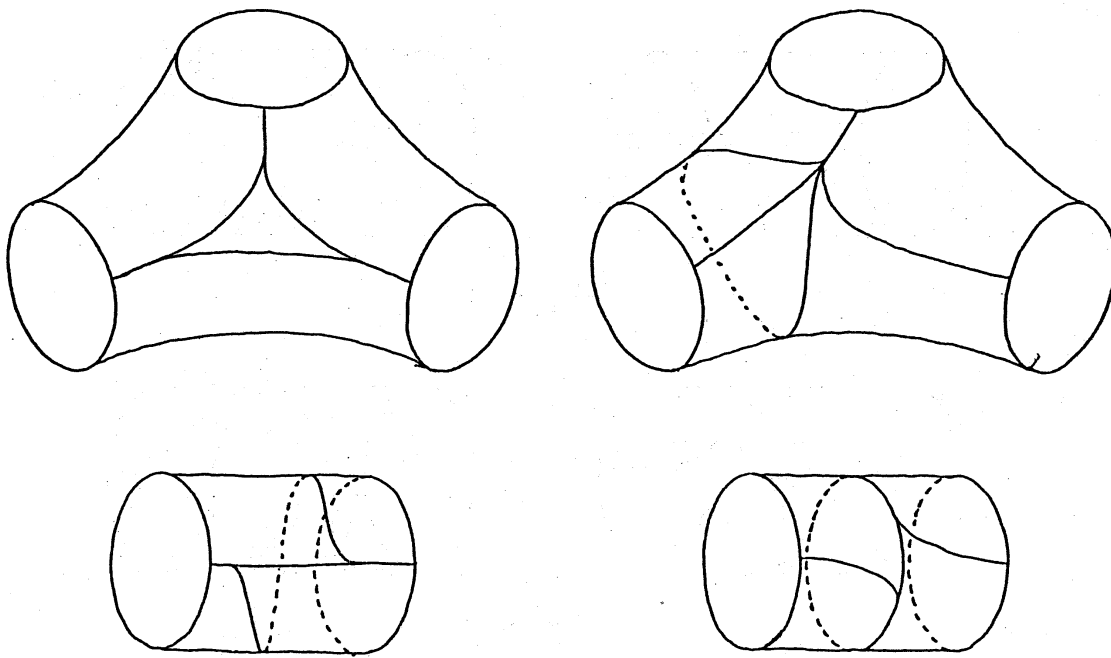

Figure 1

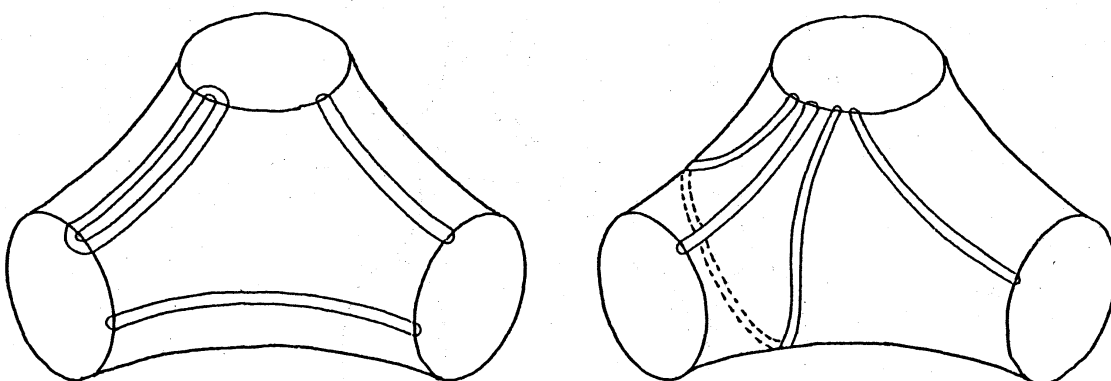
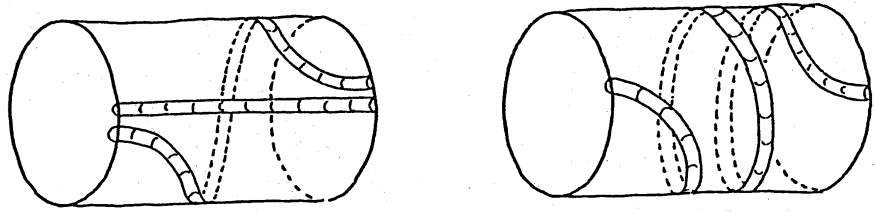
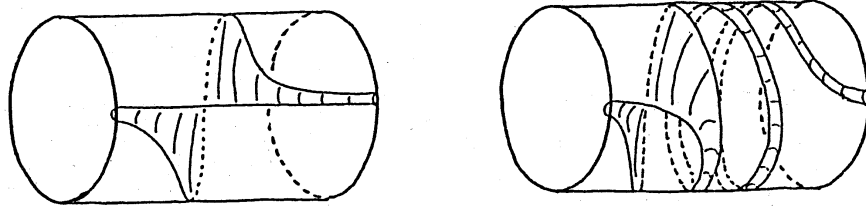

Figure 2



type a



type b

Figure 3

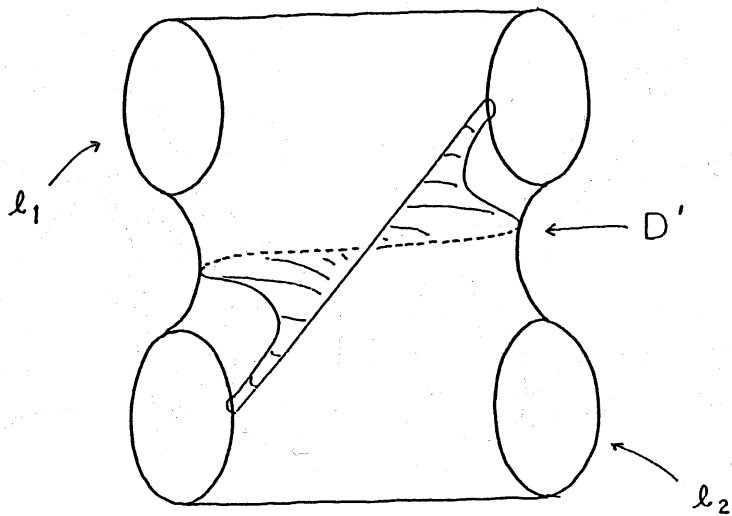

S_1

Figure 4

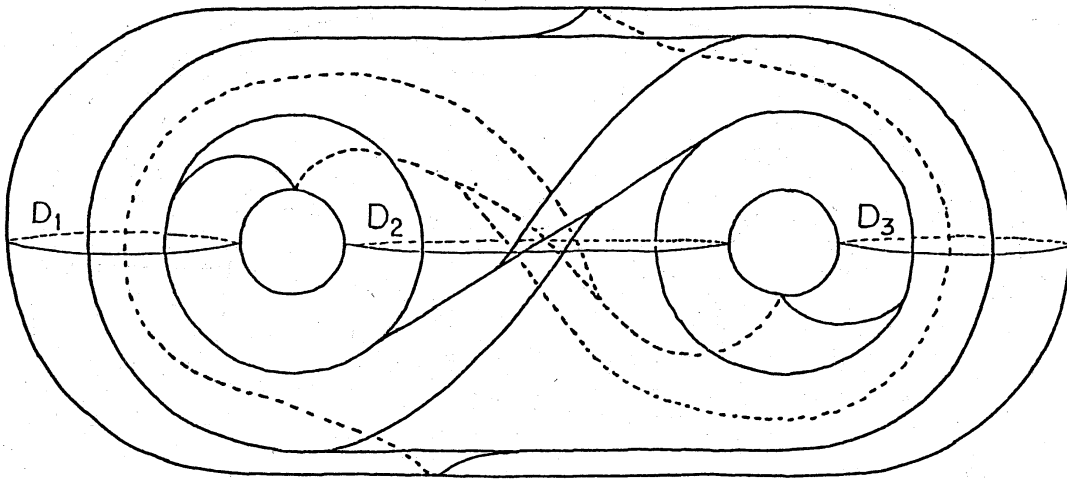

Figure 5

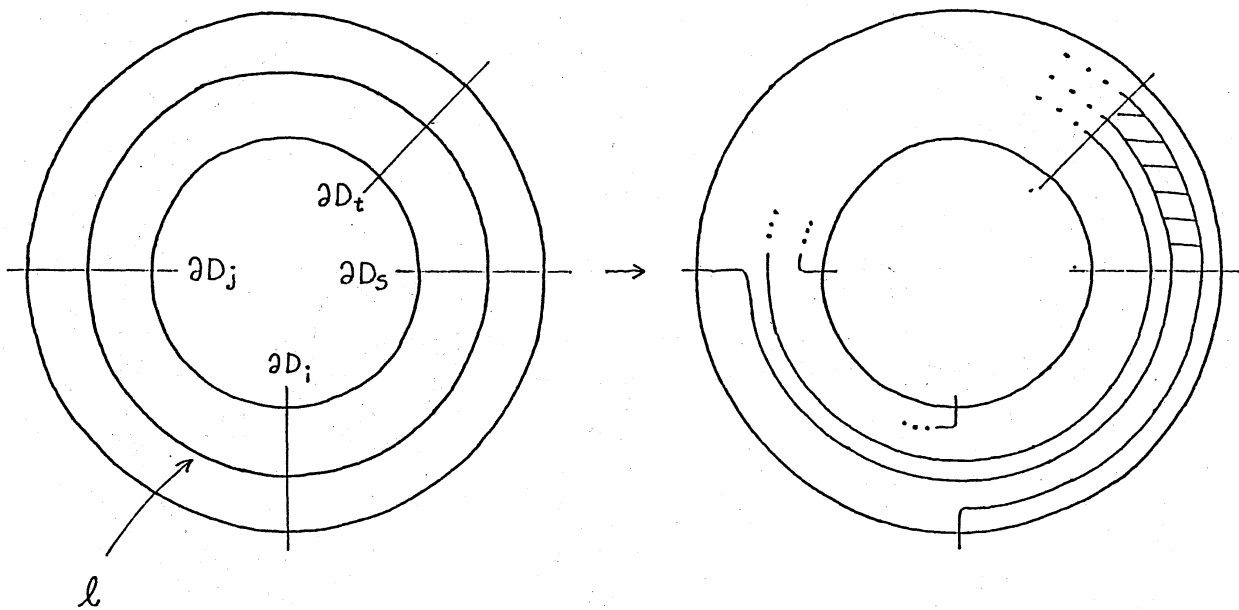
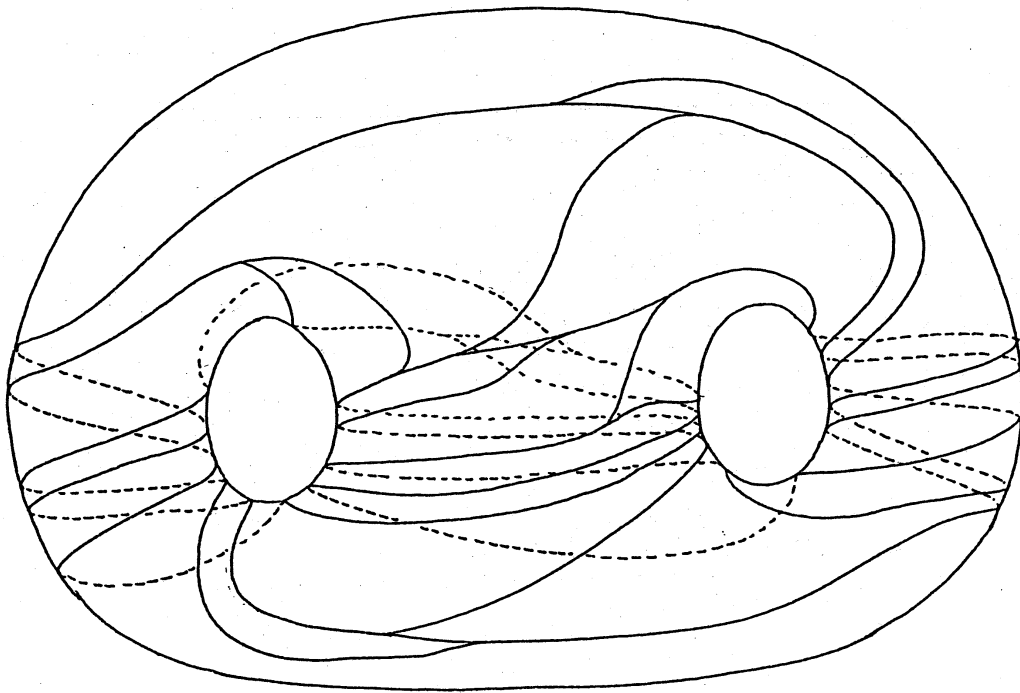
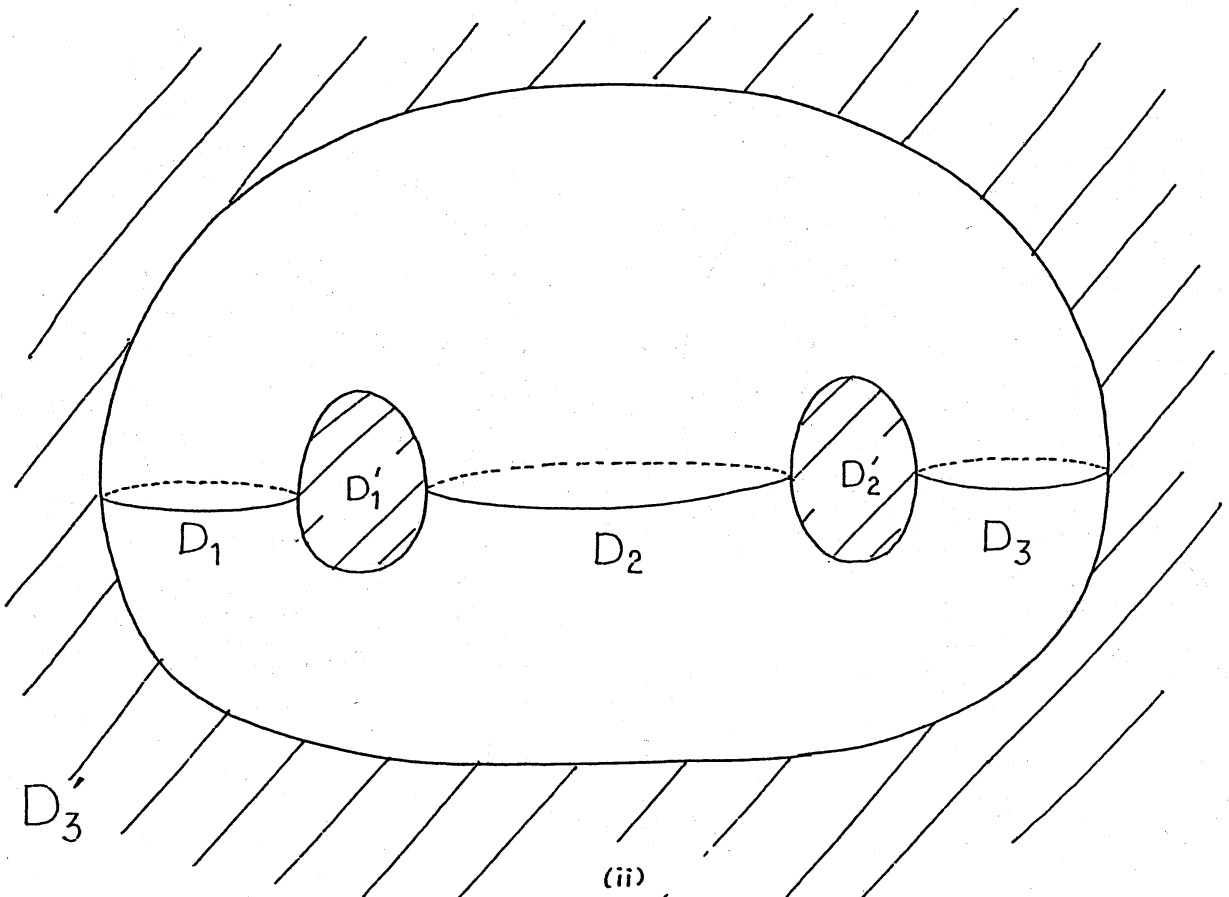

Figure 6



(i)

Figure 7



(ii)

Figure 7