

Oscillatory Phenomenon in Chemistry
Development of Temporal Order in Molecular Assembly

Kenichi Yoshikawa 吉川 研一

College of General Education, University of Tokushima,
Minamijosanjima, Tokushima 770, JAPAN

ABSTRACT

After the brief introduction on non-linear oscillations in various chemical systems, two oscillatory systems were focused as the typical examples of the non-linear, non-equilibrium chemical oscillations : (1) Electrical oscillation in an oil-water interface and (2) periodic water-flow in a system with salt-water and pure-water.

Rhythmic, sustained electrical oscillation was generated for an oil-water interface, containing a surfactant in the water phase, where typical oscillatory patterns in non-linear oscillators were observed. Oscillatory flow of salt-water and pure-water was observed when the vessel of salt-water was connected with narrow pore to the vessel to pure-water. Interestingly, entrainment of the oscillatory flows was obtained when two oscillators were coupled. These experimental results were interpreted using a theory based on a set of non-linear differential equations.

1. Introduction

Various biological systems exhibit rhythmic phenomena, e.g., oscillations of cells of nerve and muscle tissue including heart, oscillations in mitochondria and biological clocks. These phenomena have recently received much attention as "dissipative" effect¹⁾ in non-linear, non-equilibrium systems. However, biological systems are, in general, too complicated to understand the full detail of the mechanism of oscillation. A biophysist Belousov in USSR found a periodic change

of chemical reaction in a homogeneous aqueous-solution when he was studying oxidative reaction of citric acid.²⁾ This compound is a key metabolite for living organisms to uptake energy from foods. This system is now called the Belousov-Zhabotinskii reaction.³⁾ The Belousov-Zhabotinskii reaction has recently received much attention from many physicists and also mathematicians as a typical non-linear oscillatory system. This is because the Belousov-Zhabotinskii reaction shows various interesting phenomenon, i.e., limit cycle oscillations, multi-periodicity, hysteresis, entrainment, chaos, formation of spacial structures such as developing target or spiral pattern.⁴⁾ To simulate there interesting features, non-linear difference equations have been proposed which could reproduce the oscillatory phenomenon at least qualitatively.⁴⁾ As is shown in Table I, there are many other chemical oscillatory systems beside the Belousov-Zhabotinskii reaction.^{5,6)} All of them has not been interpreted fully and should be solved based on the theory of non-linear, non-equilibrium

Table I Various Chemical Oscillations

	System	Temporal Oscillation	Spacial Oscillation	Related Systems
Belousov-Zhabotinskii Reaction				$\text{H}_2\text{O}_2\text{-KIO}_3\text{-H}_2\text{SO}_4$
Oxidation by Peroxidase				Oscillation in Glycolysis
Fluorescence				Pulsation in Laser
Catalytic Oxidation of CO				Oxidation of H_2 by Pt or Ni
Iron Wire in HNO_3				$\text{Au}/4\text{N HCl}$ $\text{Zn}/4\text{N NaOH}$
Liesegang Ring				$\text{Pb}^{2+}\text{-I}^-$ in a Gel etc.

thermodynamics.

If one thinks of various oscillatory phenomena in biological systems, one will notice that interface or membrane plays an essential role to induce oscillation. For example, excitation in biological nervous membrane is caused by the gating flow of Na^+ and K^+ was across

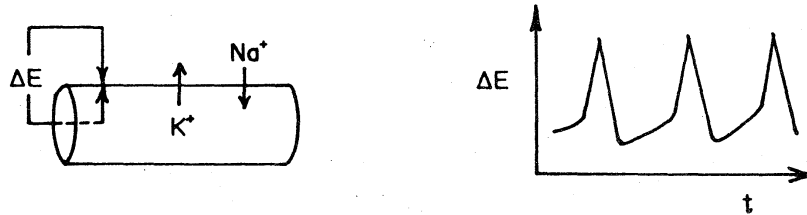

Chart. Excitation in Biological Nervous Membrane

Table II Oscillations in Artificial Membrane

Membrane	Oscillation	Driving Force	Researcher(year)
Glass Filter	1 V 30min	Hydrostatic Pressure Direct Current (25mA)	Teorell (1958)
Ion-Exchange Membrane	0.1 V 0.1 sec 20msec	Direct Current	Yamamoto (1961) Shashoua (1967)
Membrane from Dry-Oil	0.1 V 0.2sec	Direct Current	Monnier (1964)
Bilayer Lipid Membrane + Proteneous Compound	20 mV 1 sec	Direct Current	Mueller & Rudin (1967)
Porous Filter with a Lipid	20mV 1 min	Direct Current	Kobatake (1970)
Bilayer Lipid Membrane (BLM)	10mV 1 min	Chemical Reaction KI , pH 10 & $\text{Fe}(\text{CN})_6^{4-}$, pH 5	Pant & Rosenberg (1971)

the nervous membrane.⁷⁾ The concentration difference of Na^+ and K^+ ions inside and outside the membrane are the driving force of the excitation. Thus, in order to understand the mechanism of biological excitation and/or oscillation, studies of artificial membranes with excitability become important. Most of the artificial membranes examined were excitable under an external force, such as pressure, voltage, or electric current (Table II). On the other hand, in excitable biomembranes the difference in the compositions of electrolytes, especially K^+ and Na^+ , across the membrane plays the essential role. Investigations on "self-excitable" artificial membranes are therefore important in understanding the mechanism and/or oscillation in biological systems.

In the present article, we would like to describe on two "self-excitable" chemical systems, i.e., electrical oscillation at an oil-water interface and oscillatory flow in a simple system with salt-water and pure-water.

2. OSCILLATIONS AT AN OIL-WATER INTERFACE

2-1 Oscillatory Phenomenon in Oil-Water Two-Phase System

Mass transfer accompanying chemical reactions is involved in many biological and industrial processes. Under certain conditions it causes interfacial turbulence, i.e. the Marangoni effect.⁸⁾ In general, the movement of the interface due to the Marangoni-instability is depressed in the presence of a surfactant.⁹⁾ Contrary to this known trend, Dupeyrat et al. found^{10,11)} quasi-periodic variations of a relaxation type in the interfacial tension and the electrical potential between two immiscible phases, a solution of hexadecyltrimethyl chloride, a long-chain cationic surfactant, in water and an organic solution of picric acid in nitrobenzene. Recently we reported¹²⁾ sustained, rhythmic oscillations under conditions somewhat different from those in their experiment. We extended this study to liquid membranes in a water-oil-water system, and found that spontaneous rhythmic

oscillations of electrical potential are generated in the liquid membranes in the presence of various cationic and anionic surfactants in one of the aqueous phases.¹³⁻¹⁶⁾

2-2 Experimental Results

Experiments were performed in an apparatus in a U-shaped glass tube (12-mm inner diameter). The apparatus is shown schematically in Figure 1. A nitrobenzene solution (4ml) of 5mM 2,2'-bipyridine was placed in the base of the U cell. Aqueous solutions (10ml each) were introduced simultaneously, into the arms of the U cell, above the organic phase without stirring. All measurements were carried out at 25°C. The voltage across the liquid membrane was measured with a high-impedance voltmeter connected by two salt bridges to two Ag/AgCl electrodes.

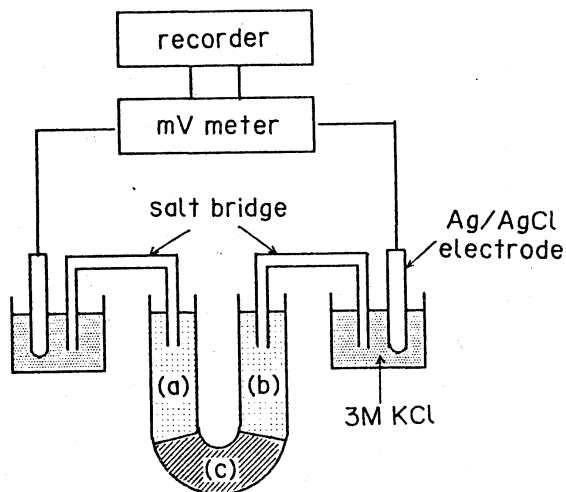
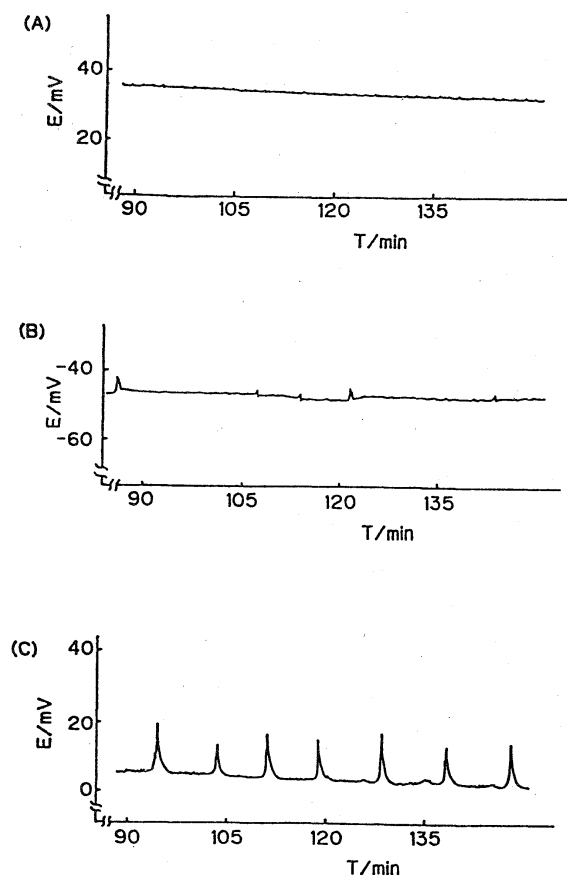

Figure 1 Experimental apparatus for measurements of the oscillation of electrical potential in a liquid membrane, water-oil-water systems. (A) Aqueous solution of surfactant, (B) 0.5M NaCl aqueous solution, (C) Nitrobenzene solution.

Figure 2 shows the tracing of the voltage oscillations across the organic phase of nitrobenzene in the presence or absence of sodium oleate and/or propanol. Though small fluctuations of the electrical

Figure 2 Oscillations of electrical potential with (A) 0.1mM sodium oleate, (B) 5 v/v% 1-propanol and (C) 0.1mM sodium oleate and 5 v/v% 1-propanol in the left aqueous layer.



potential are recognized only with sodium oleate (Figure 2A) and with propanol (Figure 2B), great pulses are generated in the presence of both sodium oleate and propanol (Figure 2C). This apparently suggests that the transfer of the surfactant and alcohol through the oil-water interface is essentially important to induce oscillations. Figure 3 shows various profile of the oscillatory pattern in the presence of several kinds of

chemical species. Figure 4 exemplifies the oscillation at an oil-water interface in the presence of a phospholipid. This result is interesting because phospholipids are the main constituent of biomembranes, including nervous membrane.

Here, it is noteworthy that rhythmic and sustained oscillations are generated spontaneously in the absence of any external stimuli such as hydrostatic pressure or electrical current. In these liquid membranes, the concentrations of the surfactant, together with other chemical substances such as alcohols, are in "far-from-equilibrium conditions". Thus, the dissipation of the free energy due to the solute transfer induces the oscillations. We have also succeeded in observing the oscillatory change of the interfacial tension.¹⁵⁾ This result suggests that rhythmic change of the electrical potential is connected with the repeated change of concentration of the surfactant at the interface.

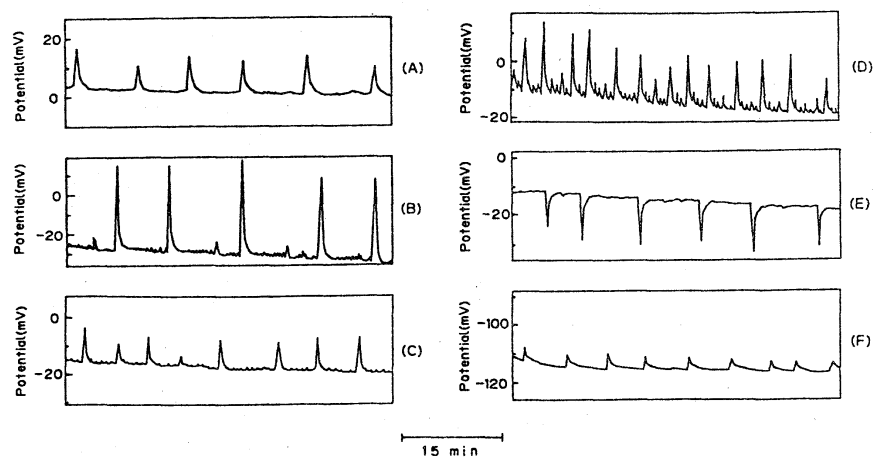

Figure 3 Oscillation of electrical potential across the organic layer between two aqueous solutions, one of which contains 0.1mM sodium oleate. (A) 5 v/v% 1-propanol and (B) 5 v/v% 1-butanol. (C)-(F) show the oscillations induced by the addition of 0.5ml of (C) 0.1M sodium chloride, (D) 1M sucrose, (E) 1mM quinine chloride, and (F) 0.03M hydrochloric acid to the left aqueous solution which contains 10 v/v% 1-propanol.

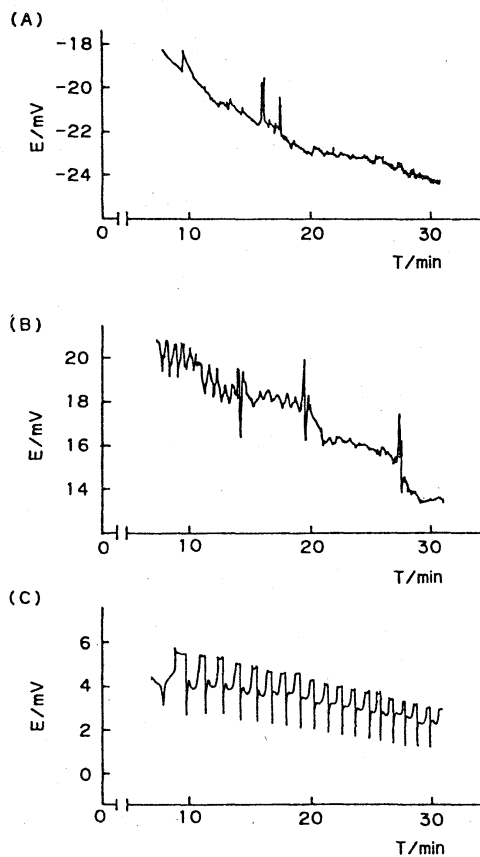

Figure 4 Oscillations of electrical potential with (A) 0.0035 w/v%, (B) 6 v/v% 1-butanol, soybean lecithin, and (C) 6 v/v% 1-butanol and 0.0035 w/v% soybean lecithin.

2-3 Comparison of the Effect of Alcohol on the Oscillatory Profile with Various Types of Surfactants.

We have found that spontaneous oscillations of electrical potential occur across a liquid membrane of nitrobenzene placed between two aqueous layers, one of which contained a cationic surfactant, such as cetyltrimethylammonium bromide (CTAB).¹³⁾ It has also been found that the liquid membrane of nitrobenzene exhibits a spontaneous oscillation even when CTAB is replaced by an anionic surfactant such as sodium dodecyl sulfate (SDS).^{14,15)}

The changes in patterns of oscillations of the liquid membrane with CTAB, SDS and sodium oleate, in response to added alcohols, are shown schematically in Figure 5. In the liquid membrane with CTAB, the frequency increased with an increase in the hydrophobicity of the alcohol, whereas the amplitude remained essentially constant. For the liquid membrane with SDS, the shape of the oscillations changed remarkably. In the liquid membrane with sodium oleate, the amplitude increases but the frequency did not change so much with an increase in the bulkiness of the alkyl chain of the alcohol.

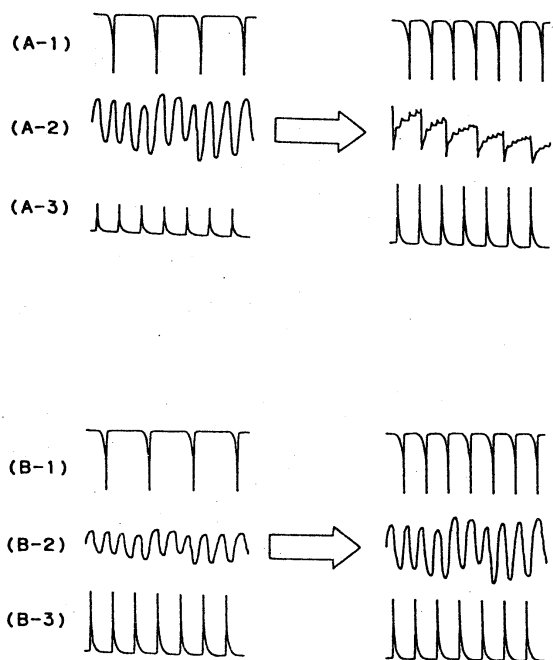

Figure 5 Schematic representation of the effect of the manner of oscillations with (A) the increase of alkyl chain and (B) the increase of concentration of alcohol for the liquid membrane with (A-1,B-1) CTAB, (A-2,B-2) SDS and (A-3,B-3) sodium oleate.

When the concentration of the alcohol was increased, the frequency increased in the liquid membrane with CTAB. A similar change of the oscillations was encountered for the liquid membrane with SDS. However, no marked change of oscillation was observed for the liquid membrane with sodium oleate. These results suggest that, by studies on excitable phenomena in various liquid membranes, it may be possible to develop a new type of chemical sensor capable of distinguishing various chemical substances quantitatively, on the basis of information on the amplitude, frequency and shape of electrical pulses.¹³⁾

2-4 Mechanism of the Oscillation

The mechanism for the sustained oscillations in the liquid membrane can be explained in the following manner. Here, we would like to explain the oscillation for the oil-water system with sodium oleate, as an example. As a first step, oleate anions (Ole^-), which are mainly present as micelles in the aqueous phase, move towards the interface and become situated at the interface. Simultaneously, molecules of alcohol move toward the interface. Ole^- and alcohol molecules move toward the interface in a cooperative manner. Thus, the concentrations of Ole^- and alcohol near the interface increase gradually, and the surfactant, Ole^- , tends to form a monolayer at the interface. When the concentration of the anionic surfactant at the interface reaches a critical value, Ole^- are abruptly transferred to the organic phase owing to the increase of the surface pressure. The Ole^- molecules at the interface then, form inverted micelles in the organic phase. This step should be associated with the transfer of alcohol from the interface to the organic phase. After the abrupt decrease of the Ole^- concentration at the interface, accumulation of the surfactant begins and the cycle is repeated.

2-5 Phenomenological Equation to Interpret the Oscillation

The above interpretation of the mechanism, although of necessity somewhat speculative, provides a useful kinetic model. Let X , Y and Z be the concentrations of the key chemicals; X_i , the concentration of Ole^- near the interface; Y_i , the concentration of alcohol near the interface; Z_i , the concentration of the aggregate or complex of Ole^- and alcohol at the interface. The following scheme can be considered as the mechanism to be correlated with the oscillation in the liquid membrane, where X_b and Y_b mean the concentrations of Ole^- and alcohol in the bulk aqueous phase.

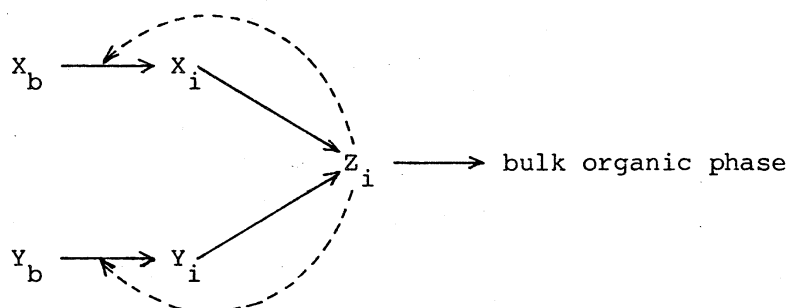

It may be expected that the rates of transfer of Ole^- and alcohol, k_1 and k_2 , respectively, are affected by the negative feedback of Z_i . A dotted arrow indicates this effect. In other words, the diffusion rate, k_1 , of Ole^- from the aqueous phase to the interface may decrease with the net increase of Ole^- at the interface, X_i and Z_i . A similar situation may hold for the diffusion rate, k_2 , of alcohol from the aqueous phase to the interface.

The system kinetics may be considered under the following assumptions: (a) the concentrations of Ole^- and alcohol in the bulk aqueous phase remain constant; (b) the rates of diffusion of Ole^- and alcohol from the bulk aqueous phase to the interface are expressed as $k_1(a_1 - b_1 X_i - Z_i)$ and $k_2(a_2 - b_2 X_i - Z_i)$, respectively; (c) the rate of formation of Z_i from X_i and Y_i is expressed as a function $F(X_i, Y_i)$; and (d) the rate of escape of Z_i into the bulk organic phase is expressed as a function $G(Z_i)$. Under these assumptions, the kinetics of the migrations of Ole^- and alcohol are written by the differential equations.

$$dX_i/dt = k_1 (a_1 - b_1 X_i - Z_i) \quad (1-a)$$

$$dY_i/dt = k_2 (a_2 - b_2 Y_i - Z_i) \quad (1-b)$$

$$dZ_i/dt = k_3 (F(X_i, Y_i) - G(Z_i)) \quad (1-c)$$

$F(X_i, Y_i)$ is given by $c(X_i + Y_i)$, a simple form for synergetic effect of X_i and Y_i , and a_i , b_i , and c are constants.

Self-oscillatory states can be obtained if $G(Z_i)$ has "N"-shape non-linearity. $G(Z_i)$ may be simply expressed as a cubic function.

$$G(Z_i) = -Z_i + Z_i^3/3 \quad (2)$$

The physical meaning of this non-linearity is assumed based on the fact that 2-dimensional system of surfactant molecules frequently shows "N"-shape non-linearity for the relationship for the surface pressure vs. concentration.¹⁷⁾

2.6 Analogy with the Oscillation in an Electrical Circuit

Let us consider an electrical circuit with a negative resistor shown in Figure 6.

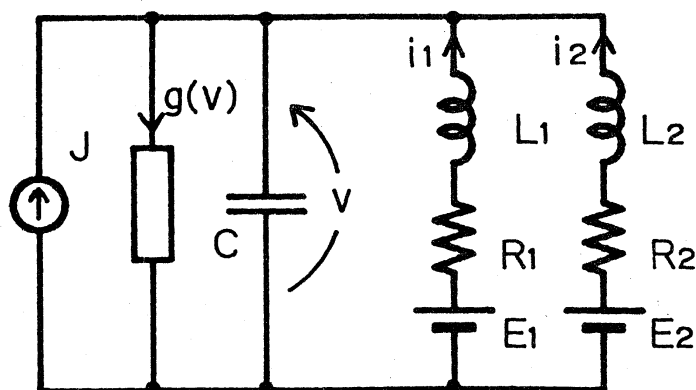

Figure 6 Oscillatory electrical circuit analogous to the liquid-membrane oscillator.

The governing equations of this circuit are as follows.

$$L_1 \frac{di_1}{dt} = E_1 - R_1 i_1 - v \quad (3-a)$$

$$L_2 \frac{di_2}{dt} = E_2 - R_2 i_2 - v \quad (3-b)$$

$$C \frac{dv}{dt} = i_1 + i_2 + J - g(v) \quad (3-c)$$

It is clear that eq. (3) corresponds to eq. (1). If the branch with L_2 is open, the set of (3-a) and (3-c) become the BVP equation.¹⁸⁾ BVP equation is quite famous as a model equation to interpret the excitatory phenomena in biological nervous membrane. In the usual BVP equation, interesting features such as multi-periodicity, chaos and intermittency could not be produced and, thus, the various types of oscillations as are shown in Figure 3 could not be obtained either.

The minimum requirement to reproduce the various characteristic features beside the simple limit-cycle oscillation in non-linear systems is to use three variables, as in eq. (3).

It is also to be noted that the BVP equation is a useful model system in the oscillatory phenomena in the nervous membrane, where the transfer of ionic species such as Na^+ and K^+ is the driving force of the oscillation. In our oscillatory phenomena at an oil-water interface, the transfer of surfactant and alcohol induce the periodic change. Thus, the mechanisms of oscillations in the nervous membrane and in the oil-water system are analogous each other from the view point of molecular process.

Figure 7 exemplifies the numerical results of the equations. It is quite interesting to note that the numerical results in Figure 7 correspond well to those of the experimental trends shown in Figure 3. This means that various patterns of the oscillations shown at the oil-water interface are, for the most part, attributable to the change of the rate of diffusion of Ole^- and/or alcohol. The change of the diffusion rate should be induced by the chemical substances added to

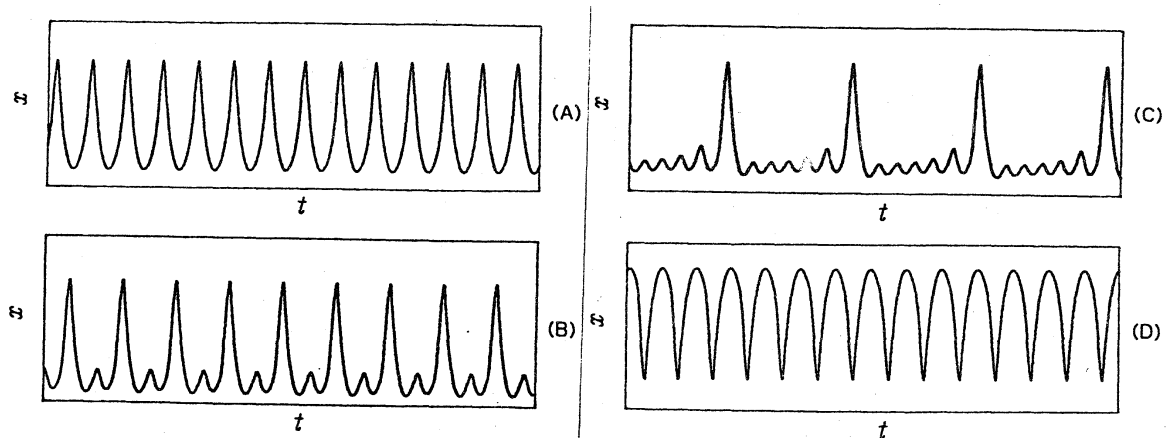

Figure 7 Computer simulation for the electrical oscillation at the oil-water interface.

Parameter : $k_1=0.6$, $k_2=0.1$, $k_3=5$, $a_2=1.4$,
 $b_1=b_2=0.5$, and $c=1.0$
 (A) $a_1=0.06$, (B) $a_1=0.1$,
 (C) $a_1=0.6$, and (D) $a_1=-2.86$

the aqueous phase. Though the experimental basis of the parameters is not yet satisfactorily resolved, it may be expected that the intrinsic nature of the oscillations in the liquid membrane can be interpreted within the context of the above theory.

3. HYDRODYNAMIC OSCILLATOR WITH SALT WATER AND PURE WATER

3-1 Discovery of the Oscillator

In 1970, Martin¹⁹⁾ found a curious phenomenon that rhythmic oscillations of water flow are generated when a vertically oriented hypodermic syringe, with the plunger removed, is filled with salt-water and partially submerged in a beaker of pure-water. The oscillations appear as a downward jet of salt-water, followed by an upward jet of pure-water, and so on for many cycles. Prior to this discovery, Teorell reported²⁰⁾ an oscillatory streaming of water solution across a porous charged membrane, separating salt solutions of different concentrations, through which a constant electric current was passed. He discussed this oscillatory phenomenon by comparing it with the excitable phenomenon in biomembranes. Though the Teorell oscillator is

that of physiology, it is somewhat too complicated because there are many thousands of pores within the membrane. We therefore decided to further investigate Martin's oscillator, in which system there is only a single path of water flow.

3-2 Outline of the Experiment

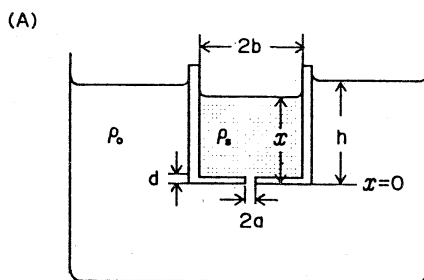

Figure 8 (A) Hydrodynamic oscillator with a plastic cup.
(B) Experimental apparatus to monitor the interference between the two hydrodynamic oscillators.

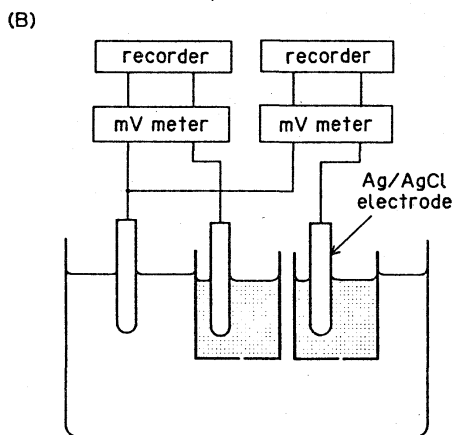

Figure 8A shows the experimental apparatus we used to observe the hydrodynamic oscillator with salt-water. Into the outer vessel was placed pure-water and into the plastic cup was poured salt-water. The experiment was started at the time when the water level of the outer vessel was slightly high in order to balance the hydrostatic pressure. When the salt-water happened to flow downward, the flow terminated after a while, and then the pure-water in the plastic cup began

to go upward through the narrow pore. It stopped after several periods of ten-seconds, and the salt-water again went downwards. This cycle was repeated again and again for more than hundred times. Periodic water flow was observed even when the pure-water began to go upward for the first time. In other words, the limit cycle is insensitive to the initial condition.

The electrical potential of the salt-water to the pure-water could be monitored with a pair of Ag/AgCl electrodes. Figures 9A and 9B indicate that the electrical potential is high when the salt-water flows downwards through the narrow pore and the potential is low when

the pure-water flows upwards into the plastic cup. It is to be noted that the electrical potential depends mainly on the direction of water flow but is almost independent on the rate of the flow.

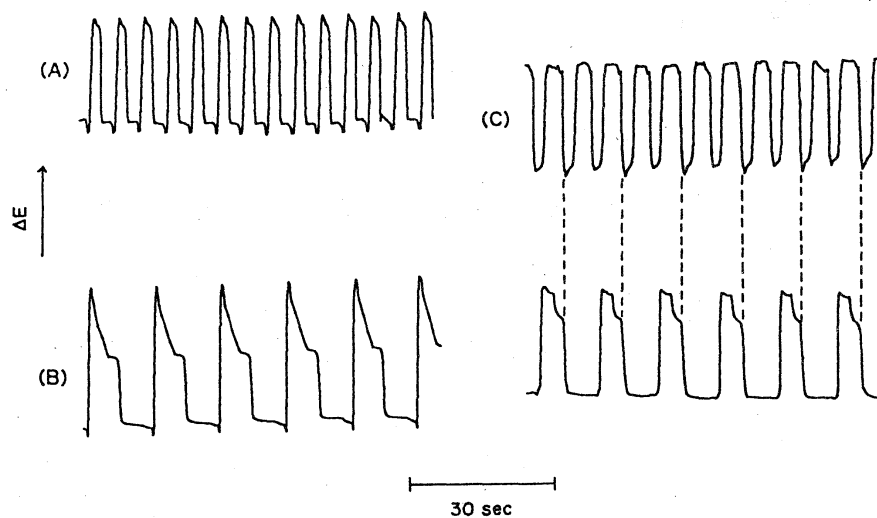

Figure 9 Oscillation of electrical potential associated with the periodic flow for a single cup, (A) 5M NaCl solution and diameter of the hole, $\phi=1.1$ mm. (C) Entrainment of the oscillations when the above two oscillators run simultaneously in the same outer vessel.

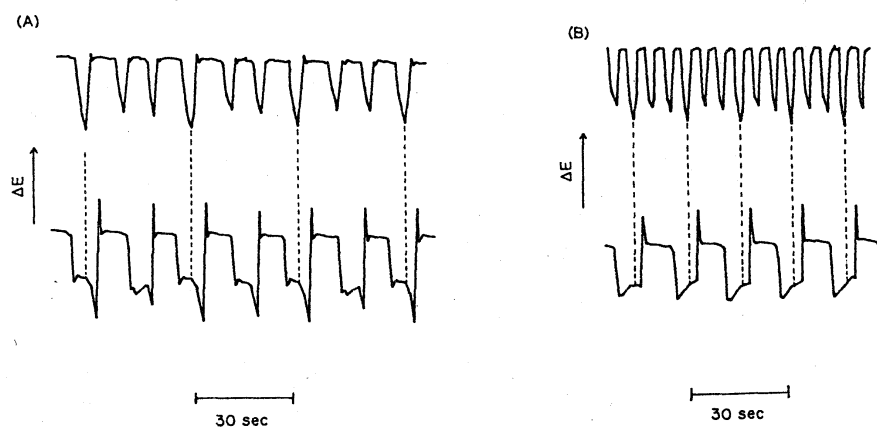

Figure 10 Entrainment of the oscillatory flows in the system of Figure 8. (A) 3M NaCl with $\phi=1.4$ mm and 3M NaCl with $\phi=1.1$ mm, and (B) NaCl with $\phi=1.4$ mm and 3M NaCl with $\phi=1.1$ mm.

Another interesting phenomenon has been observed for the oscillation of salt-water. In this case, two plastic cups were used.

The experimental apparatus is shown in Figure 8B. The result of the electrical measurement of the water flow was given in Figures 9C and 10. It is noteworthy that the frequency of oscillations are pulled in towards each other. The ratio of the entrained frequencies was found to be 1:1, 1:2, 1:3, 1:4, 2:3, 2:4, 3:4, and so on. That is, the ratio of the frequencies was modulated to the ratio of the nearest natural numbers.

3-3 Phenomenological Equations of the Oscillatory Flow

The motion of incompressible, viscous fluid is generally described using the Navier-Stokes equation,

$$\frac{\partial u}{\partial t} + (\mu \text{ grad})u = -\frac{1}{\rho} \text{grad } p + \nu \mu + k \quad (4)$$

where u : vertical velocity, ρ : density, p : pressure, k : external force per unit mass, μ : viscosity, and $\nu = \mu/\rho$. For the fluid motion within the narrow pore, Hagen-Poiseuille pipe flow is expected to represent the velocity profile. We choose a cylindrical coordinate system with its origin at the bottom of the narrow pore, so that r and z are the radial and vertical coordinates, the Navier-Stokes equation then becomes¹⁹⁾

$$\rho \frac{\partial u}{\partial t} = -\frac{\partial p}{\partial z} - \rho g + \frac{\rho \nu}{r} \frac{\partial}{\partial r} \left(r \frac{\partial u}{\partial r} \right) \quad (5)$$

In our case, ρ and ν are also time-dependent. When the flow in the narrow pore governs the whole flow in the oscillation, integration of Eq. (5) over the volume of the narrow tube gives the approximate governing Eq. (6), except for the short period that the tube is filled with both salt-water and pure-water, i.e. when the direction of flow is inverted.

$$\rho_j \frac{\partial u}{\partial t} = \frac{p(0) - p(d)}{d} - \rho_j g + \frac{2\rho_j \nu_j}{a} \frac{\partial u}{\partial r} \Big|_{r=a}, \quad j=1 \text{ or } 2 \quad (6)$$

where

$$u(t) = \frac{2}{a^2} \int_0^a u(r,t) r \partial r \quad (7)$$

When $j=1$, pure-water flows up the pore, so that $\rho_1 = \rho_0$ (the density of pure-water) and $\nu_1 = \nu_0$ (the viscosity of pure-water); when $j=2$, salt-water flows down the pore, so that $\rho_2 = \rho_s$ (the density of salt-water) and $\nu_2 = \nu_s$ (the viscosity of salt-water). Though ρ_j and ν_j change with time, accompanied by the oscillatory flow, the magnitudes of the variations are considerably small during one cycle of the oscillation. Actually, the pure-water entered into the plastic cup was layered at the top of the cup and the salt-water downward the vessel was placed at the bottom. Thus, it may be estimated that ρ_j and ν_j remain essentially constant, at least for the period of several oscillations. In addition, Eq. (8) approximately represents the Hagen-Poiseuille flow.

$$\frac{\partial u}{\partial r} \Big|_{r=a} = - \frac{4\bar{u}}{a} \quad (8)$$

The pressure difference, $p(0)-p(d)$, equals the hydrostatic pressure difference between the ends of the pore minus a pressure loss or a head loss, which is a function of the shape of the 'head' and the flow of kinetic energy $\rho_j \bar{u} |\bar{u}|/2$. Thus the pressure difference becomes, for upward flow,

$$p(0)-p(d) = \rho_0 gh - \rho_s g(x-d) - \alpha \rho_0 \bar{u} |\bar{u}| \quad (9-a)$$

and for downward flow,

$$p(0)-p(d) = \rho_0 gh - \rho_s g(x-d) - \beta \rho_s \bar{u} |\bar{u}| \quad (9-b)$$

where $\alpha (\leq 1)$ and $\beta (\leq 1)$ are the parameters depending on the shape of the 'head' and, thus, on the effective section-area of the flow just after

the narrow pore. From continuity and incompressibility, we obtain Eq. (10).

$$\dot{x} = \frac{dx}{dt} = \frac{a^2}{b^2} \bar{u} \quad (10)$$

From Eqs. (22)-(27), the following equations are obtained. For upward flow,

$$\frac{\rho_0 b^2}{a^2} \ddot{x} + \frac{\alpha \rho_0 b^4}{da^4} \dot{x}^2 + \frac{8\rho_0 v_0 b^2}{a^4} \dot{x} + \frac{\rho_s g}{d} x - \rho_0 f(\dot{x}) = \frac{\rho_0 gh}{d} + (\rho_s - \rho_0)g \quad (11-a)$$

and for downward flow,

$$\frac{\rho_s b^2}{a^2} \ddot{x} - \frac{\beta \rho_s b^4}{da^4} \dot{x}^2 + \frac{8\rho_s v_s b^2}{a^4} \dot{x} + \frac{\rho_s g}{d} x - \rho_s f(\dot{x}) = \frac{\rho_0 gh}{d} \quad (11-b)$$

The function, $f(\dot{x})$, is the force originated from the continuity of the fluid and the effect to accelerate the motion of the fluid in the pore. This is because the portion of the fluid just passed through the pore is successively accelerated due to the density gradient. As it is quite difficult to estimate the precise function, $f(\dot{x})$, theoretically, we have assumed $f(\dot{x})$ is expressed as a simple function, where A and B are the constants.

$$f(\dot{x}) = \{A(\rho_s - \rho_0) + B\}\dot{x} = (A\Delta\rho + B)\dot{x} \quad (12)$$

The result of a model calculation using Eqs. (11-a) and (11-b) is shown in Figure 11. The entrainment of the two cup-oscillators are also simulated, taking into the relationship among the water levels of outer vessel and the two cups. These experimental and theoretical results clearly demonstrate that the cup-oscillator is a useful system to study non-linear oscillations, because this system is one of the most simple non-linear oscillators.

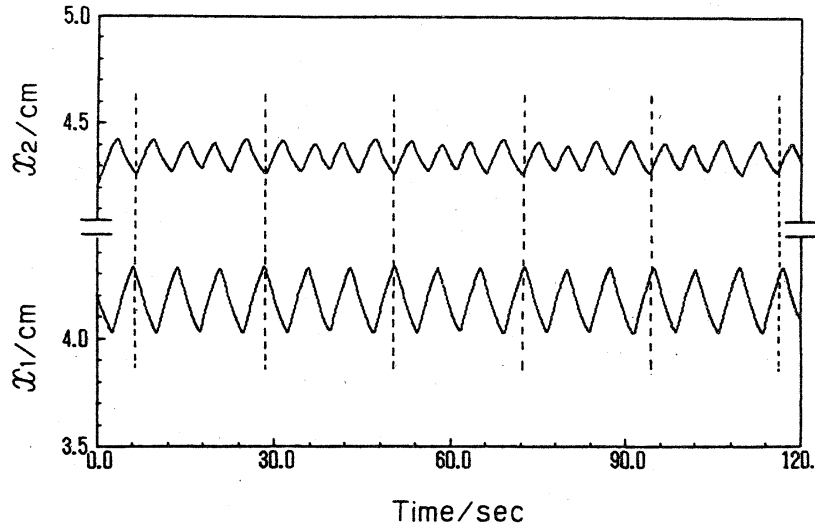

Figure 11 Computer simulation of the entrainment of the oscillatory flows in the system of Figure 8B. Parameters : $\rho_0=1.0$, $a=0.05$ cm, $d=0.1$ cm, $b=2.5$ cm, $v_0 = v_s = 0.01$ cm²/s, $\alpha_2 = \beta = 0.01$, and area of the outer surface in 628 cm². Function, $f(\dot{x}) = a^2(200\Delta\rho + 18)\dot{x}/b^2$. Two different cups with $\rho_s = 1.2$ and $\rho_s = 1.15$ were used, where the periods for the each single cup were originally 7.96 sec and 5.73 sec, respectively. Due to the entrainment, the periods became 7.32 sec and 5.49 sec about 4:3, as are shown in the figure. Thus the relative ratio of the period was changed from 1.39 to 1.33 ($\approx 4/3$).

ACKNOWLEDGMENTS

The author thanks Profs. H. Kawakami, T. Waki, Dr. S. Maeda, Mrs. O. Shima, M. Shoji, S. Nakata and M. Yamanaka for their collaboration. This work was partly supported by a Grant-in-Aid for Scientific Research to K. Y. from the Ministry of Education, Science and Culture of Japan, the Shimadzu Science Foundation, and the Inamori Science Foundation.

Reference

- 1) Nicolis, G. and Prigogine, I., "Self-Organization in Nonequilibrium Systems-From Dissipative Structures to Order through Fluctuations", John Wiley & Sons, New York (1977).
- 2) Belousov, B. P., Ref. Radiats. Med., 1958,145(1959).
- 3) Zhabothinskii, A. M., Dokl. Akad. Nauk SSSR,157,392(1964).
- 4) Field, R. J. and Burger, M., "Oscillations and Travelling Waves in Chemical Systems", John Wiley & Sons, New York(1985).
- 5) Franck, V., Angew.Chem.Int.Ed.Engl.,17,1(1978).
- 6) Yoshikawa, K and Hayakawa, T., Kagakuno-Ryouiki (Japanese), 34,612(1980).
- 7) Hodgikin, A. L. and Huxley. A. F., J.Physiol.,116,449,473, 497, *ibid.*,117,500(1952).
- 8) "Interfacial Kinetics in Solution" Faraday Discuss.Chem.Soc., p.p.77,313(1984).
- 9) Linde, H., Schwartz, P. and Wilke, H., "Dynamics and Instability of Fluid Interfaces", Sørensen, T. S. Ed., Springer-Verlag, Berlin, p.75-119(1979).
- 10) Dupeyrat, M. and Nakache, E., Bioelectrochem. Bioenerg.,5,134(1978).
- 11) Nakache, E., Dupeyrat, M. and Vigres-Alder, M., Faraday Discuss.Chem. Soc.,77,189(1984).
- 12) Yoshikawa, K and Matsubara, Y, J.Am.Chem.Soc.105,5967(1983).
- 14) Yoshikawa, K, Nakata, S, Omoichi, T, and Colaccico, G, Langmuir 2,715(1986).
- 15) Nakata, K, Yoshikawa, K, and Ishii, T, Nippon Kagaku Kaishi (Chem.Soc. Jpn.),495(1987).
- 16) Yoshikawa, K. and Ishii, T., Stud. Org. Chem.,31,4777(1987).
(A Collection of the Invited Lectures Presented at the 8th IUPAC Conference on Phys. Org. Chem., Kobayashi, M. Ed., Elsevier, Amsterdam).
- 17) Adamson, A. W. "Physical Chemistry of Surfaces"; Intersci. p.p.629, Pub., New York(1960).
- 18) FitzHugh, R., Biophys. J., 1,445(1961).
- 19) Martin, S., Geophys. Fluid Dynamics, 1, 143(1970).
- 20) Teorell, T. J. Gen. Physiol., 42, 831(1959).