

INVARIANTS OF 3-MANIFOLDS ASSOCIATED WITH QUANTUM GROUPS AND VERLINDE'S FORMULA

TOSHIE TAKATA

九大理 · 高田敏恵

Introduction

In [14], Witten obtained new topological invariants of closed 3-manifolds and links in 3-manifolds from the quantum field theory. Shortly afterwards, in [11], Reshetikhin and Turaev defined related invariants of closed oriented 3-manifolds and links in such 3-manifolds, by means of representations of quantum groups. More precisely, they use quantized universal enveloping algebra $U_q(\mathfrak{sl}(2, \mathbb{C}))$, which is a q -deformation of the universal enveloping algebra $\mathfrak{sl}_2(\mathbb{C})$ discovered independently by Drinfeld [1] and Jimbo ([2],[3]). The algebra $U_q(\mathfrak{sl}(2, \mathbb{C}))$ has a structure of a Hopf algebra. Reshetikhin and Turaev introduced the additional structure in the case $q = \exp \frac{2m\pi\sqrt{-1}}{r}$ called a 'modular' Hopf algebra to define invariants of 3-manifolds. They obtain invariants of 3-manifolds as a combinational formula using invariants of framed link associated with the algebra $U_q(\mathfrak{sl}(2, \mathbb{C}))$. This is based on the fact that any closed connected oriented 3-manifold is obtained by Dehn surgery [10] of S^3 along a framed link [7].

As an application of the invariants, we construct a projectively linear representation of $SL(2, \mathbb{Z})$. Let $Z(T^2)$ be an $(r - 1)$ -dimensional vector space over \mathbb{C} and $\{e_i\}_{i=0}^{r-2}$ a basis of the vector space $Z(T^2)$ and we associate to a basis e_i a solid torus U_i which has a link in the interior. Gluing such two solid tori U_i and U_j by an element X of the mapping class group of the torus T^2 , we obtain a closed 3-manifold M_X with a link. We denote the

Typeset by $\mathcal{A}\mathcal{M}\mathcal{S}$ -TEX

invariant of the resulting manifold by X_{ij} , which is denoted by M_X . We define an action ρ of $SL(2, \mathbb{Z})$ on the vector space $Z(T^2)$ by the formula

$$\rho(X) e_j = \sum_{i=0}^{r-2} X_{ij} e_i \quad (j = 0, \dots, r-2).$$

For generators S and T of $SL(2, \mathbb{Z})$, we obtain the equations

$$S_{ij} = \sqrt{\frac{2}{r}} \sin \frac{m(i+1)(j+1)\pi}{r},$$

$$T_{ij} = q^{\frac{i(i+2)}{4}} \delta_{ij}$$

This matrix (S_{ij}) is the unitary matrix and the representation of $SL(2, \mathbb{Z})$ by means of the matrices above was discovered by Kac and Peterson [4] to describe the modular property of the character of the affine Lie algebra and was also used by Kohno [5] to define invariants of 3-manifolds. The above representation

$$\rho : SL(2, \mathbb{Z}) \rightarrow GL(Z(T^2)) / \langle C \rangle$$

is a projectively linear representation, where $\langle C \rangle$ is the cyclic group generated by a root of unity $C = \exp \sqrt{-1}(-\varphi + \frac{3\pi m}{2r} - \frac{\pi}{2})$. Here φ is determined from the following Gauss sum;

$$\sqrt{2r} \exp(\sqrt{-1}\varphi) = \sum_{k=0}^{2r-1} \exp(\sqrt{-1}\pi k^2 m / 2r)$$

As an application, we prove 'Verlinde's Formula' for $SU(2)$ [13]. This is given by the following formula:

$$\frac{S_{ij} S_{ik}}{S_{i0}} = \sum_{l=0}^{r-2} S_{il} N_{ljk},$$

where

$$N_{ijk} = \begin{cases} 1 & \text{if } |i-j| \leq k \leq i+j, i+j+k \in 2\mathbb{Z}, i+j+k \leq 2(r-2) \\ 0 & \text{otherwise.} \end{cases}$$

We verify it by computing the invariant of $S^2 \times S^1$ with a link in two ways. The proof is similar to that by Witten [14], but our approach is based on representations of $U_q(sl(2, \mathbb{C}))$ with $q = \exp \frac{2m\pi\sqrt{-1}}{r}$.

The paper is organized as follows. In §1, we review some of the results in [11]. We explain a representation of a modular Hopf algebra and define invariants of links and 3-manifolds derived by Reshetikhin and Turaev. In §2, using the invariants derived in §1, we establish a representation of $SL(2, \mathbb{Z})$. The action of generators S and T on the vector space $Z(T^2)$ is represented by matrices and it is shown that they satisfy their relations. In §3, a proof of ‘Verlinde’s formula’ for $SU(2)$ is presented. To compute the invariants, we make use of the idea in §2.

1. Review

1.1 Modular Hopf algebra U_t

In [11], Reshetikhin and Turaev give U_t as an example of ‘modular’ Hopf algebra. In this paper, we consider the definition of topological invariants of 3-manifolds for this modular Hopf algebra U_t . We explain this modular Hopf algebra U_t . For a non zero $q \in \mathbb{C}$, $U_q(sl_2)$ is the Hopf algebra which is a q -deformation of the universal enveloping algebra of Lie algebra $sl_2(\mathbb{C})$. Let us recall the definition of U_t due to Reshetikhin and Turaev. Let q be a root of unity and $t = \exp(\pi\sqrt{-1}m/2r)$ where m and r are mutually prime integers with odd m , $2r - 1 \geq m \geq 1$, $r \geq 2$ and $q = t^4$. We fix an integer r satisfying $r \geq 2$. We define U_t to be the associative algebra with unit over the cyclotomic field $\mathbb{Q}(t)$ with 4 generators K, K^{-1}, X, Y satisfying the following relations:

$$XY - YX = \frac{K^2 - K^{-2}}{t^2 - t^{-2}} \quad (1.1.1)$$

$$XK = t^{-2}KX, YK = t^2KY \quad (1.1.2)$$

$$K^{4r} = 1, X^r = Y^r = 0 \quad (1.1.3)$$

The relations (1.1.1), (1.1.2) define the algebra $U_q(sl_2)$. The structure of Hopf algebra in $U_q(sl_2)$ induces a structure of a Hopf algebra in U_t . The action of comultiplication Δ ,

counit ε , antipode γ are given on the generators by the following formulas.

$$\Delta(X) = X \otimes K + K^{-1} \otimes X \quad (1.1.4)$$

$$\Delta(Y) = Y \otimes K + K^{-1} \otimes Y \quad (1.1.5)$$

$$\Delta(K) = K \otimes K \quad (1.1.6)$$

$$\varepsilon(X) = \varepsilon(Y) = 0, \varepsilon(K) = 1 \quad (1.1.7)$$

$$\gamma(X) = -t^2 X, \gamma(Y) = -t^{-2} Y, \gamma(K) = K^{-1} \quad (1.1.8)$$

The structure of the ribbon Hopf algebra in $U_q(sl_2)$ induces a structure of the ribbon Hopf algebra in U_t . Thus U_t has the universal R -matrix $R \in U_t \otimes U_t$ due to Drinfel'd [1] which satisfies Yang Baxter equation, $u \in U_t$ defined from R , and $v \in U_t$ which is a central element of U_t . If $R = \sum_i \alpha_i \otimes \beta_i$, then $u = \sum_i \gamma(\beta_i) \alpha_i$ and $v = uK^{-2}$. Moreover, U_t satisfies six axioms (see [11, §3]) and has a structure of modular Hopf algebra. We describe the representation of modular Hopf algebra U_t . Let I be a finite set of integers $\{0, 1, \dots, r-2\}$. For an integer $i \in I$, V_i denotes $(i+1)$ -dimensional irreducible representation of U_t . It is an $(i+1)$ -dimensional U_t -module. The action ρ of the generator K of U_t on V_i has the following matrix representation:

$$\rho(K) \mapsto \begin{pmatrix} t^i & & & 0 \\ & t^{i-2} & & \\ & & \ddots & \\ 0 & & & t^{-i} \end{pmatrix} \quad (1.1.9)$$

For any U_t -module V_i we provide the dual linear space $V_i^\vee = \text{Hom}_{\mathbb{C}}(V, \mathbb{C})$ with the action of U_t :

$$\rho_{V_i^\vee}(a) = (\rho_{V_i}(\gamma(a)))^* \in \text{End } V_i^\vee$$

The matrix representation of this action is given by the following matrix:

$$\rho_{V_i^\vee}(K) \mapsto \begin{pmatrix} t^{-i} & & & 0 \\ & t^{-i+2} & & \\ & & \ddots & \\ 0 & & & t^i \end{pmatrix} \quad (1.1.10)$$

Let V_i, V_j be U_t -modules and ρ_{V_i} (resp. ρ_{V_j}) the action of U_t on V_i (resp. V_j). Their tensor product is the U_t -module $V_i \otimes V_j$ equipped with the action of U_t defined by the formula for $a \in U_t$:

$$\rho_{V_i \otimes V_j}(a) = (\rho_{V_i} \otimes \rho_{V_j})(\Delta(a))$$

Here Δ is the comultiplication of U_t . One may consider the category $\text{Rep } U_t$ of finite dimensional linear representations of U_t . The objects of $\text{Rep } U_t$ are left U_t -modules

$$V_{i_1}^{\varepsilon_1} \otimes \cdots \otimes V_{i_k}^{\varepsilon_k}$$

where $i_l \in I, \varepsilon_l \in \{\pm 1\}, V_{i_l}^{+1} = V_{i_l}, V_{i_l}^{-1} = V_{i_l}^\vee, 1 \leq l \leq k$. The morphisms of $\text{Rep } U_t$ are U_t -linear homomorphisms.

Definition 1.1. Let V be an object of $\text{Rep } U_t$. For any linear operator $f : V \rightarrow V$, we define its quantum trace $\text{tr}_q f$ to be the ordinary trace over \mathbb{C} of linear operator

$$f' : V \rightarrow V, f'(x) = \rho(u^{-1}v)f(x).$$

In particular, if f is the identity map id_V , then we denote $\text{tr}_q id_V$ by $\dim_q V$ and call it the quantum dimension of V . Note that if $V = V_j$, for $j \in I$, then using $v = u^{-1}K^2$ and (1.1.9), we get

$$\begin{aligned} \dim_q V_j &= \text{tr}_q(id_{V_j}) = \text{Tr}(\rho_{V_j}(K^2)id_{V_j}) \\ &= \sum_{n=0}^j t^{j-2n} = \frac{t^{2j+2} - t^{-2j-2}}{t^2 - t^{-2}} = [j+1] \end{aligned} \quad (1.1.11)$$

$$\text{where } [n] = \frac{t^{2n} - t^{-2n}}{t^2 - t^{-2}} = \frac{\sin(\pi n/r)}{\sin(\pi/r)}$$

In [11], Reshetikhin and Turaev proved the following theorem.

Theorem 1.2 (Reshetikhin-Turaev). Let $V_i (i \in I)$ be an irreducible representation of U_t . There exists a decomposition

$$V_i \otimes V_j = (\oplus_k V_k) \oplus Z_{ij} \quad (1.1.12)$$

as a U_t -module, where k satisfies the following conditions

$$|i-j| \leq k \leq i+j, i+j+k \in 2\mathbb{Z}, \quad (1.1.13)$$

$$i+j+k \leq 2(r-2). \quad (1.1.14)$$

Moreover Z_{ij} is certain U_t -module and has the next property. For any integers $i, j \in I$ and any U_t -linear homomorphism $f : Z_{ij} \rightarrow Z_{ij}$, the quantum trace of f is equal to zero.

$$\text{tr}_q f = 0 \quad (1.1.15)$$

1.2 Ribbon graph

An oriented, directed, homogeneous ribbon tangle is a collection of ribbons and annuli as illustrated in Fig.1 ([11],[12]).

Fig.1

A ribbon (annulus) is oriented if it has an orientation as a surface in \mathbb{R}^3 . By the shaded regions, we express that the tangle is oriented (Fig.1). A tangle is homogeneous if each twist of all ribbons and annuli in the tangle is a full twist. A ribbon tangle is directed if the cores of its ribbons and annuli are provided with directions. For each ribbon tangle we assign a finite dimensional irreducible representation V_i of U_t to each component, where i is called its colour. The procedure is called colouring and we denote it by λ . In Fig.2, elementary coloured ribbon tangles is sketched. We consider ribbons which are called coupons. A small neighborhood of each coupon Q is depicted in Fig.3, where the rectangle illustrates the coupon. A colour of each coupon is a \mathbb{C} -linear homomorphism defined from the colours and directions of the ribbons gluing to it. We add coupons to the tangle.

Fig.2 Fig.3

Let us introduce the category \mathcal{H} of ribbon graphs. The objects of \mathcal{H} are sequences

$$\eta = ((i_1, \varepsilon_1), \dots, (i_k, \varepsilon_k)) \quad (i_1, \dots, i_k \in I, \varepsilon_1, \dots, \varepsilon_k \in \{1, -1\}),$$

where $i_1, \dots, i_k \in I$ and $\varepsilon_1, \dots, \varepsilon_k \in \{1, -1\}$. We denote the set of such sequences by N . If $\eta, \eta' \in N$, then a morphism $\eta \rightarrow \eta'$ is a coloured ribbon graph (considered up to isotopy) such that the sequence of colours and directions of the bottom (resp. top) ribbons is equal to η (resp. η'). The composition $\Gamma' \circ \Gamma$ of such two morphisms $\Gamma : \eta \rightarrow \eta'$, $\Gamma' : \eta' \rightarrow \eta''$ is the ribbon graph obtained by gluing the bottom ends of Γ' with the corresponding

top ends of Γ . The tensor product of objects η, η' is their juxtaposition η, η' (see Fig.4).

Fig.4

1.3 Invariants of closed 3-manifolds

For two categories $Rep U_t$ and \mathcal{H} , Reshetikhin and Turaev show that there exists a unique covariant functor with five properties (see §2.5 in [11]). They define U_t -linear homomorphisms corresponding to elementary coloured ribbon graphs pictured in Fig.2 and graphs pictured in Fig.5.

Fig.5

Since the graphs $J_i^+, J_i^-, X_{ij}^+, X_{ij}^-, a_i, b_i, c_i, d_i$ generate the category \mathcal{H} , the compositions and tensor products of the corresponding homomorphisms determine $F(\Gamma)$ for a coloured ribbon tangle Γ . In particular, a coloured $(0,0)$ -ribbon tangle Γ defines \mathbb{C} -linear homomorphism $\mathbb{C} \rightarrow \mathbb{C}$, i.e. a multiplication by a certain element of \mathbb{C} . The element is a regular isotopy invariant of Γ . It is also denoted by $F(\Gamma)$.

Example 1.3 Let Γ be a coloured $(0,0)$ -ribbon tangle in Fig.6.

Then $F(\Gamma) = F(b_i) \circ F(c_i)$ and an easy computation shows $F(\Gamma) = \dim_q V_i$.

Fig.6

Let us recall that $\dim_q V_i$ is equal to the quantum trace of identity homomorphism. The following lemma generalizes this computation.

Lemma 1.4. *Let Γ be a coloured (k, k) -ribbon graph which corresponds to an endomorphism of a certain sequence $\eta \in N$. Let L be the coloured $(0,0)$ -ribbon tangle obtained by closing Γ (see Fig.7). Then $F(L) = \text{tr}_q F(\Gamma)$.*

Fig.7

We introduce the presentation of closed 3-manifolds via framed links. A framed link in the 3-sphere is a finite collection L of disjoint smoothly embedded circles L_1, \dots, L_l in S^3 , each component L_k of L is provided with a framing which is an integer n_k . Let ω be an orientation of L . We may regard each component L_k of the annulus with n_k full twists. This identification gives us a $(0,0)$ -ribbon tangle $\Gamma(L, \omega)$. The notation ω may be thought

of as the directions of the annuli. Let λ be a colouring of $\Gamma(L, \omega)$. Then $F(\Gamma(L, \omega, \lambda))$ is a regular isotopy invariant of coloured $(0,0)$ -ribbon tangle $\Gamma(L, \omega, \lambda)$. By means of the above results, we define invariants of closed 3-manifolds. The idea of their construction is reduced to the following theorem which relates framed links to closed 3-manifolds.

Theorem 1.5 (Lickorish [7]). *Each closed connected oriented 3-manifold can be obtained by Dehn surgery on S^3 along a certain framed link.*

Let M be a closed connected oriented 3-manifold and L a framed link in S^3 with components L_1, \dots, L_l and framing n_1, \dots, n_l which can be related to M by the above theorem. Dehn surgery is the following process. We remove an open tubular neighborhood of each L_k on the resulting toral boundary and glue l solid tori such that their meridians are identified with the curves on the boundaries. We consider such a pair (M, L) . Let ω be an orientation of the framed link L . By $\text{col}(L)$ we denote the set of colourings of the $(0,0)$ -ribbon tangle $\Gamma(L, \omega)$. Put

$$F(M, L) = C^{\sigma(L)} \sum_{\lambda \in \text{col}(L)} \prod_{k=1}^l d_{\lambda(L_k)} F(\Gamma(L, \omega, \lambda)) \in \mathbb{C}. \quad (1.3.1)$$

Here C, d_k ($k = 0, \dots, r-2$) are constants contained in the data of the modular Hopf algebra U_t and given by the following formulas:

$$C = \exp(-\sqrt{-1}d), \quad (1.3.2)$$

$$d_k = \sqrt{\frac{2}{r}} \sin \frac{m(k+1)\pi}{r}, \quad (1.3.3)$$

where

$$d = \varphi - \frac{3\pi m}{2r} + \frac{\pi}{2}, \quad (1.3.4)$$

the number φ being determined from the following Gauss sum

$$\sqrt{2r} \exp(\sqrt{-1}\varphi) = \sum_{k=0}^{2r-1} \exp(\sqrt{-1}\pi k^2 m/2r). \quad (1.3.5)$$

The notation $\sigma(L)$ stands for the signature of the linking matrix of the framed link L . We remark that the normalization coincides with that in [6].

Theorem 1.6 (Reshetikhin-Turaev). For a closed connected oriented 3-manifold M , $F(M, L)$ is a topological invariant of M .

We may denote $F(M, L)$ by $F(M)$. The invariant is multiplicative with respect to a connected sum:

$$F(M_1 \# M_2) = F(M_1)F(M_2). \quad (1.3.6)$$

We have the following relations between invariants with opposite orientations

$$F(M) = \overline{F(-M)},$$

where the bar is the complex conjugation.

Example 1.7 The formula (1.3.6) implies that $F(S^3) = 1$.

Since $S^2 \times S^1$ is obtained by Dehn surgery on S^3 along an unknotted circle with framing 0, we have

$$\begin{aligned} F(S^2 \times S^1) &= \sum_{i=1}^{r-2} d_i \dim_q V_i \\ &= \sqrt{\frac{r}{2}} \left(\sin \frac{m\pi}{r} \right)^{-1} \end{aligned} \quad (1.3.7)$$

Here we used the equation $\dim_q V_i = \sin \frac{m(i+1)\pi}{r} / \sin \frac{m\pi}{r}$. In the case $m = 1$, $F(S^2 \times S^1)$ is equal to Kohno's invariant $\phi_K(S^2 \times S^1)$ with $K = r + 2$.

Let M be a closed connected oriented 3-manifold and T be a coloured (0,0)-ribbon tangle in M . As above, let us present M as the result of surgery on S^3 along a framed link L with components L_1, \dots, L_l . The ribbon tangle $T \cup \Gamma(L, \omega, \lambda)$ may be thought of as a coloured (0,0)-ribbon tangle in S^3 . We put

$$F(M, T; L, \omega) = C^{\sigma(L)} \sum_{\lambda \in \text{col}(L)} \prod_{k=1}^l d_{\lambda(L_k)} F(T \cup \Gamma(L, \omega, \lambda)). \quad (1.3.8)$$

Then $F(M, T; L, \omega)$ is a topological invariant of the pair (M, T) . We put $F(M, T) = F(M, T; L, \omega)$. In particular, we have $F(S^3, T) = F(T)$.

2. A representation of $SL(2, \mathbb{Z})$

Using the invariants defined in §1, we establish a projectively linear representation of $SL(2, \mathbb{Z})$. Let M_1 be the mapping class group of torus T^2 . We fix a basis a, b in $H_1(T^2) \cong \mathbb{Z} \oplus \mathbb{Z}$ as depicted in Fig.8.

Fig.8

The group M_1 may be canonically identified with $SL(2, \mathbb{Z})$. A presentation of $SL(2, \mathbb{Z})$ is given by

$$SL(2, \mathbb{Z}) = \langle S, T : S^4 = I, (ST)^3 = S^2 \rangle, \quad (2.1)$$

where $S = \begin{pmatrix} 0 & -1 \\ 1 & 0 \end{pmatrix}$, $T = \begin{pmatrix} 1 & 1 \\ 0 & 1 \end{pmatrix}$. Let $Z(T^2)$ be an $(r-1)$ -dimensional vector space over \mathbb{C} and $\{e_0, e_1, \dots, e_{r-2}\}$ a basis of the vector space. We associate to each e_i a solid torus U_i with an annulus T_i in the interior, depicted in Fig.9.

Fig.9

We suppose that the colour of annulus T_i is $i \in \{0, \dots, r-2\}$ and the direction as in Fig.9. We construct a projectively linear representation

$$\rho : SL(2, \mathbb{Z}) \rightarrow GL(Z(T^2)) / \langle C \rangle,$$

where C is given by (1.3.2) and $\langle C \rangle$ means the cyclic group generated by $C \cdot I$, when I denotes the identity matrix.

For any element X of $SL(2, \mathbb{Z})$, put

$$\rho(X)e_j = \sum_{i=0}^{r-2} X_{ij}e_i. \quad (2.2)$$

Let $[h]$ be an isotopy class in M_1 corresponding to X . The map h is a degree 1 homeomorphism $T^2 \rightarrow T^2$. We identify ∂U_i and ∂U_j using h . The resulting closed connected 3-manifold with the $(0,0)$ -ribbon tangle consisting of two annuli T_i, T_j is denoted by M_X . Then X_{ij} in (2.2) is defined by the following formula:

$$X_{ij} = F(M_X, T_i \cup T_j) / F(S^2 \times S^1) \quad (2.3)$$

Clearly, it follows from the definition that X_{ij} does not depend on the choice of the representative element of the isotopy class.

Theorem 2.1. *The following homomorphism constructed above is a projectively linear representation.*

$$\rho : SL(2, \mathbb{Z}) \rightarrow GL(Z(T^2))/\langle C \rangle,$$

where $\langle C \rangle$ means the cyclic group generated by $C \cdot I$ in $GL(Z(T^2))$ with C given by (1.3.2).

The values of S_{ij} , I_{ij} and T_{ij} are given by the following formulas:

$$S_{ij} = \sqrt{\frac{2}{r}} \sin \frac{m(i+1)(j+1)\pi}{r},$$

$$I_{ij} = \delta_{ij},$$

$$T_{ij} = t^{i(i+2)} \delta_{ij}.$$

proof. Firstly, let us compute S_{ij} , I_{ij} , and T_{ij} .

(1) the case $X = S$

M_S is the 3-sphere S^3 . Two annuli T_i, T_j are linked in M_S and make up the Hopf link (see Fig.10).

Fig.10

Therefore we get $F(M_S, T_i \cup T_j) = F(T_i \cup T_j)$. One computes

$$F(T_i \cup T_j) = \sin \frac{m(i+1)(j+1)\pi}{r} / \sin \frac{m\pi}{r}. \quad (2.4)$$

Applying (2.3) with (1.3.7) and (2.4), we get

$$S_{ij} = \sqrt{\frac{2}{r}} \sin \frac{m(i+1)(j+1)\pi}{r}. \quad (2.5)$$

(2) the case $X = I$

M_I is $S^2 \times S^1$. In M_I , T_i and T_j are unlinked unknotted annuli with no twists (see Fig.11). Let us consider S^3 with the above annuli and the unknotted circle L that links a pair of the annuli and that has the zero framing as illustrated in Fig.12a.

Fig.11

The Dehn surgery on S^3 along L produces $S^2 \times S^1$ with T_i and T_j depicted in Fig.11. To calculate $F(T_i \cup T_j \cup \Gamma(L, \omega, \lambda))$, we can use the formula (1.1.2)

$$V_i \otimes V_j = (\oplus_k V_k) \oplus Z_{ij}.$$

Let us replace T_i and T_j with a unknotted annulus T_k which runs parallel to T_i and T_j (Fig.12b). We assume that T_k has a colour k and the same direction as two annuli. Then $T_k \cup \Gamma(L, \omega, \lambda)$ is a $(0,0)$ -ribbon tangle in S^3 .

Fig.12a Fig.12b

The property (1.1.15) of the U_t -module Z_{ij} ensures the equation

$$F(T_i \cup T_j \cup \Gamma(L, \omega, \lambda)) = \sum_k F(T_k \cup \Gamma(L, \omega, \lambda)), \quad (2.6)$$

where the summation runs over k satisfying (1.1.13) and (1.1.14). As $T_k \cup \Gamma(L, \omega, \lambda)$ is the Hopf link, we can apply (2.4) to the computation of $F(T_k \cup \Gamma(L, \omega, \lambda))$. If $\lambda(L) = l$, then we obtain

$$F(T_k \cup \Gamma(L, \omega, \lambda)) = F(S^2 \times S^1) \sqrt{\frac{2}{r}} \sin \frac{m(k+1)(l+1)\pi}{r}. \quad (2.7)$$

Thus, we get

$$I_{ij} = \frac{1}{F(S^2 \times S^1)} \sum_{l=0}^{r-2} d_l \left(\sum_k F(S^2 \times S^1) \sqrt{\frac{2}{r}} \sin \frac{m(k+1)(l+1)\pi}{r} \right),$$

where k satisfies the conditions (1.1.13) and (1.1.14). We have the following formula:

$$\sum_{l=0}^{r-2} \sin \frac{m(i+1)(l+1)\pi}{r} \sin \frac{m(l+1)(j+1)\pi}{r} = \frac{r}{2} \delta_{ij}. \quad (2.8)$$

Using (2.8), we show the formula:

$$I_{ij} = \frac{2}{r} \sum_k \frac{r}{2} \delta_{0k}.$$

The condition (1.1.13) of k asserts that k is equal to zero if and only if $i = j$. Therefore we get

$$I_{ij} = \delta_{ij}. \quad (2.9)$$

(3) the case $X = T$

M_T is also $S^2 \times S^1$. But the unknotted annulus T_i with no twists links the unknotted annulus T_j with one full twist (Fig.13). To obtain $(M_T, T_i \cup T_j)$, we start from S^3 with

the two above annuli T_i and T_j and with an unknotted circle L which has the zero framing and which links them (Fig.14a). Carrying out the Dehn surgery on S^3 along the circle L turns S^3 into $M_T \cong S^2 \times S^1$.

Fig.13

One claims that we can make use of the idea of the case $X = I$ to calculate $F(T_i \cup T_j \cup \Gamma(L, \omega, \lambda))$. We deform the annulus T_i adding the same twist as the annulus T_j . One denotes the resulting annulus by T_i' . The computation in [11, the proof of Lemma 7.1] implies

$$F(T_i' \cup T_j \cup \Gamma(L, \omega, \lambda)) = (v_i)^{-1} F(T_i \cup T_j \cup \Gamma(L, \omega, \lambda)),$$

where $v_i = t^{i(i+2)}$. A full twist can be expressed by a curl (Fig.14b). It follows from it that we can turn $T_i' \cup T_j$ into two parallel annuli with no twists (Fig.14c).

Let T_k be an annulus of colour k provided with the same twist and direction as two annuli. We replace two annuli by T_k (Fig.14d).

Fig.14a Fig.14b Fig.14c Fig.14d

Then, applying theorem 1.2, one may get the following equation

$$F(T_i' \cup T_j \cup \Gamma(L, \omega, \lambda)) = \sum_{\substack{k \\ |i-j| \leq k \leq i+j \\ i+j+k \in 2\mathbb{Z} \\ i+j+k \leq 2(r-2)}} F(T_k \cup \Gamma(L, \omega, \lambda)),$$

Thus

$$T_{ij} = \frac{1}{F(S^2 \times S^1)} \sum_{l=0}^{r-2} d_l v_i \sum_k F(T_k \cup \Gamma(L, \omega, \lambda))$$

here $\lambda(L) = l$. Substituting $v_i = t^{i(i+2)}$, we obtain

$$T_{ij} = t^{i(i+2)} \delta_{ij}. \quad (2.10)$$

We put $I_{id} = (I_{ij})$, $S = (S_{ij})$ and $T = (T_{ij})$. They are $(r-1) \times (r-1)$ matrices.

Let us prove that ρ is a projectively linear representation. To do this, it is sufficient to show the following:

$$S^4 = I_{id} \quad \text{mod } C \cdot I \quad (2.11)$$

$$(ST)^3 = S^2 \quad \text{mod } C \cdot I \quad (2.12)$$

One easily computes

$$S^2 = I_{id}. \quad (2.13)$$

Note that the equation $(ST)^3 = S^2$ is equivalent to the equation $STS = T^{-1}ST^{-1}$. It is easy to compute that an (i, j) -entry of $T^{-1}ST^{-1}$ is

$$\sqrt{\frac{2}{r}} t^{i(i+2)+j(j+2)} \sin \frac{m(i+1)(j+1)\pi}{r}. \quad (2.14)$$

Using $t = \exp(\pi\sqrt{-1}m/2r)$ and Gauss sum (1.3.5), an (i, j) -entry of STS is

$$C \sqrt{\frac{2}{r}} t^{i(i+2)+j(j+2)} \sin \frac{m(i+1)(j+1)\pi}{r}. \quad (2.15)$$

It follows from (2.14) and (2.15) that

$$STS = T^{-1}ST^{-1} \cdot CI_{id}. \quad (2.16)$$

(2.13) implies (2.11) and (2.16) implies (2.12). \square

3.Proof of Verlinde's formula

As another application of the invariants given in §1, we prove 'Verlinde's formula' (see [13]). It is given by the following formula.

$$\frac{S_{ij} S_{ik}}{S_{i0}} = \sum_{l=0}^{r-2} S_{il} N_{ljk} \quad (3.1)$$

where m and r are mutually prime integers with odd m , $1 \leq m \leq 2r - 1$, $r \leq 2$, and

$$S_{ij} = \sqrt{\frac{2}{r}} \sin \frac{m(i+1)(j+1)\pi}{r}, \quad (3.2)$$

$$N_{ijk} = \begin{cases} 1 & \text{if } |i-j| \leq k \leq i+j, i+j+k \in 2\mathbb{Z}, i+j+k \leq 2(r-2) \\ 0 & \text{otherwise.} \end{cases}$$

Proof of Verlinde's formula. Let us consider $S^2 \times S^1$ with three parallel non-twisted annuli T_l, T_j, T_k in the interior (see Fig.15). The directions of them is as in Fig.15 and the colour of T_l (resp. T_j, T_k) is l (resp. j, k).

Fig.15

We call this configuration of three annuli \widetilde{L}_{ljk} . The idea of the proof is to evaluate $F(S^2 \times S^1, \widetilde{L}_{ljk})$ in two ways.

Let us begin with the surgery representation of $(S^2 \times S^1, \widetilde{L}_{ljk})$. Let L be an unknotted circle with the zero framing which links \widetilde{L}_{ljk} in S^3 (Fig.16a). The Dehn surgery on S^3 along the circle L produces $(S^2 \times S^1, \widetilde{L}_{ljk})$.

In the first evaluation, we use an analogue of the computation of I_{ij} and T_{ij} in §2. We replace T_j and T_k by an unknotted non-twisted annulus T_p with colour p and the same direction as them (Fig.16b). Then applying Theorem 1.2 with i replaced by l , we obtain the following equation:

$$F(\widetilde{L}_{ljk} \cup \Gamma(L, \omega, \lambda)) = \sum_p F(T_l \cup T_p \cup \Gamma(L, \omega, \lambda)).$$

Here p satisfies the conditions (1.1.13) and (1.1.14) replaced i by p .

Fig.16a Fig.16b

Then we can apply the formula (2.9) to the computation. Thus we get

$$\begin{aligned} F(S^2 \times S^1, \widetilde{L}_{ljk}) &= \sum_{l=0}^{r-2} d_l \left(\sum_p F(T_l \cup T_p \cup \Gamma(L, \omega, \lambda)) \right) \\ &= F(S^2 \times S^1) \sum_{\substack{p \\ |i-j| \leq p \leq j+k \\ p+j+k \in 2\mathbb{Z} \\ p+j+k \leq 2(r-2)}} \delta_{l,p} \end{aligned}$$

It follows from the condition of p that

$$F(S^2 \times S^1, \widetilde{L}_{ljk}) = F(S^2 \times S^1) N_{ljk} \quad (3.3)$$

To evaluate $F(S^2 \times S^1, \widetilde{L}_{ljk})$ in the second way, we rotate the $(0,0)$ -ribbon tangle $\widetilde{L}_{ljk} \cup \Gamma(L)$ in S^3 (Fig.17a). The result may be thought of as the closure of the $(1,1)$ -ribbon tangle B_{ljk}^t illustrated in Fig.17b. $F(B_{ljk}^t)$ is the homomorphism $V_t \rightarrow V_t$. Moreover, it may be thought of as the composition of three homomorphisms determined by $(1,1)$ -ribbon tangles $\tau_l^t, \tau_j^t, \tau_k^t$ illustrated in Fig.17c.

Fig.17a Fig.17b Fig.17c

The map $F(\tau_l^t)$ is a \mathbb{C} -linear homomorphism $\mathbb{C} \rightarrow \mathbb{C}$, i.e. a multiplication by an element of \mathbb{C} . We denote this element by b_l^t . Similarly, $F(\tau_j^t)$ (resp. $F(\tau_k^t)$) is a multiplication by an element b_j^t (resp. b_k^t) of \mathbb{C} . The closure of the (1,1)-ribbon tangle τ_l^t makes up the Hopf link. We denote this invariant by s_{tl} . Analogously, the invariant which corresponds to τ_j^t (resp. τ_k^t) is denoted by s_{tj} (resp. s_{tk}). Using (2,4), we derive

$$s_{t\mu} = \sin \frac{m(t+1)(\mu+1)\pi}{r} / \sin \frac{m\pi}{r},$$

where $\mu \in \{l, j, k\}$. Note that $s_{t0} = \dim_q V_t$. Then Lemma 1.5 shows that

$$s_{t\mu} = b_\mu^t \dim_q V_t = b_\mu^t s_{t0}. \quad (3.4)$$

The above discussion and (3.6) imply that

$$\begin{aligned} F(B_{ljk}^t) &= \text{tr}_q(F(\tau_l^t) \circ F(\tau_j^t) \circ F(\tau_k^t)) \\ &= b_l^t b_j^t b_k^t \dim_q V_t \end{aligned} \quad (3.5)$$

Using (3.4) and (3.5),

$$\begin{aligned} F(S^2 \times S^1, \widetilde{L}_{ljk}) &= \sum_{t=0}^{r-2} d_t F(B_{ljk}^t) \dim_q V_t \\ &= \sum_{t=0}^{r-2} d_t \frac{s_{tl} s_{tj} s_{tk}}{(s_{t0})^2} \end{aligned} \quad (3.6)$$

Multiplying (3.3) and (3.6) by s_{il} and summing up over $l = 0, \dots, r-2$, we get

$$\sum_{l=0}^{r-2} F(S^2 \times S^1) N_{ljk} = d_i \left(\sin \frac{m\pi}{r} \right)^{-2} \frac{r}{2} \frac{s_{ij} s_{ik}}{(s_{i0})^2}. \quad (3.7)$$

We remark that

$$\begin{aligned} d_i &= \sqrt{\frac{2}{r}} \sin \frac{m(i+1)\pi}{r} \\ &= \sqrt{\frac{2}{r}} s_{i0} \sin \frac{m\pi}{r}. \end{aligned} \quad (3.8)$$

Substituting (3.8) in (3.7), we obtain

$$\sum_{l=0}^{r-2} s_{il} F(S^2 \times S^1) N_{ljk} = F(S^2 \times S^1) \frac{s_{ij} s_{ik}}{s_{i0}}. \quad (3.9)$$

The value S_{ij} is related to s_{ij} by the formula

$$s_{ij} = \sqrt{\frac{r}{2}} \left(\sin \frac{m\pi}{r} \right)^{-1} S_{ij}.$$

Thus (3.9) implies (3.1). \square

REFERENCES

1. V. G. Drinfel'd, *Quantum groups*, Amer. Math. Soc. (1987), 798–820.
2. M. Jimbo, *A q -difference analogue of $U(\mathfrak{g})$ and the Yang-Baxter equation*, Letters in Math. Phys. **10** (1985), 63–69.
3. M. Jimbo, *Introduction to Yang-Baxter equation, Braid Group, Knot Theory and Statistical Mechanics*, eds. C. N. Yang and M. L. Lie (World Scientific, 1989).
4. V. G. Kac and D. H. Peterson, *Infinite dimensional Lie algebras, theta functions and modular forms*, Advances in Math. **53** (1984), 125–264.
5. T. Kohno, *Topological invariants for 3-manifolds using representation of mapping class groups I*, (to appear in Topology).
6. R. Kirby and P. Melvin, *The 3-manifold invariants of Witten and Reshetikhin-Turaev for $sl(2, \mathbb{C})$* , preprint.
7. W. B. R. Lickorish, *A representation of orientable, combinatorial 3-manifolds*, Ann. Math. **76** (1962), 531–540.
8. G. Moore and N. Seiberg, *Classical and quantum conformal field theory*, Commun. Math. Phys. **123** (1988), 177–254.
9. S. R. Morton and P. Strickland, *Jones polynomial invariants for knots for knots and satellites*, preprint.
10. D. Rolfsen, *Knots and links*, 1976.
11. N. Y. Reshetikhin and V. G. Turaev, *Invariants of 3-manifolds via link polynomials and quantum groups*, Invent. Math. **103** (1991), 547–597.
12. N. Y. Reshetikhin and V. G. Turaev, *Ribbon graphs and their invariants derived from quantum groups*, Commun. Math. Phys. **127** (1990), 1–26.
13. E. Verlinde, *Fusion rules and modular transformations in 2D conformal field theory*, Nucl. Phys. **B300** (1988), 360–376.
14. E. Witten, *Quantum field theory and the Jones polynomial*, Commun. Math. Phys. **121** (1989), 351–399.
15. D. N. Yetter, *Markov algebra*, Contemp. Math. **78** (1988), 705–730, Braids, AMS.

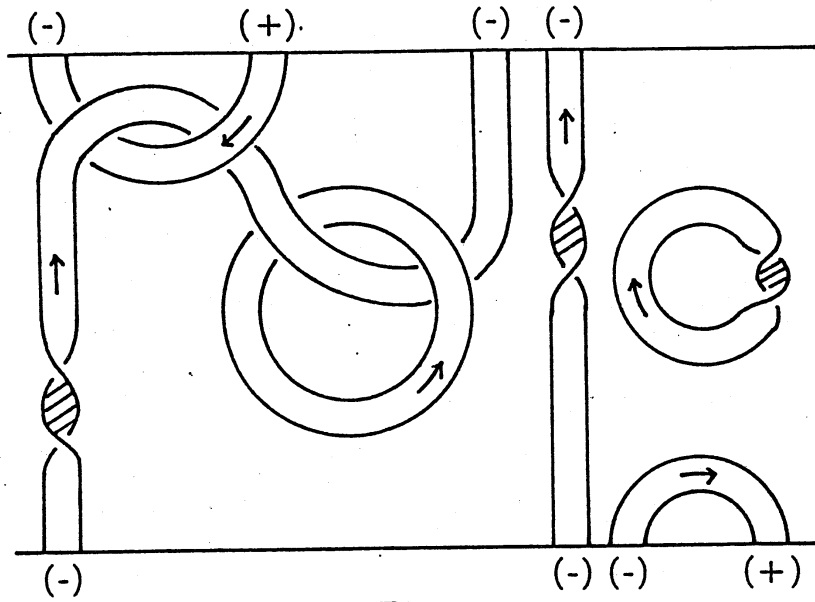

Fig.1

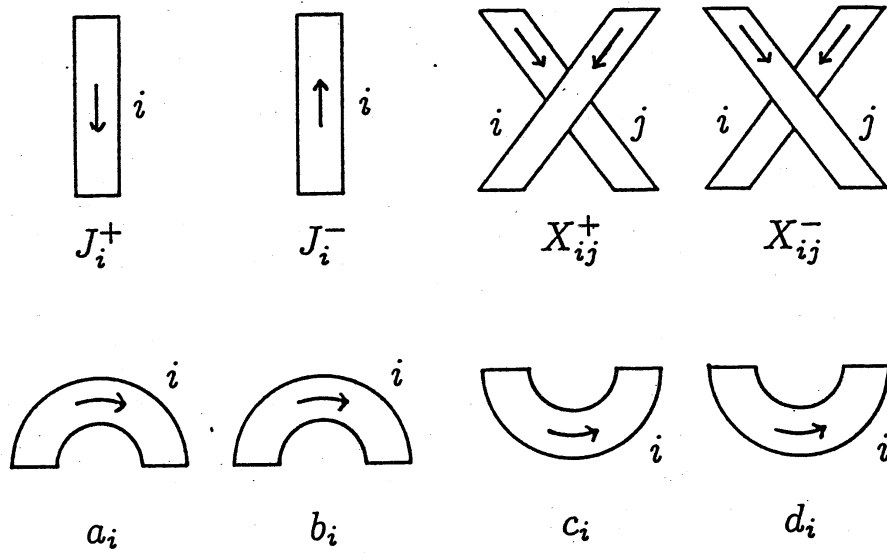

Fig.2

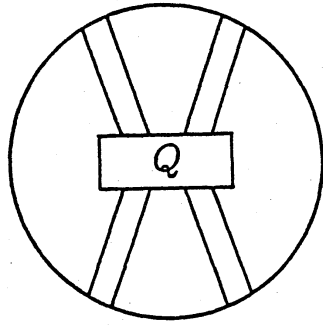

Fig.3

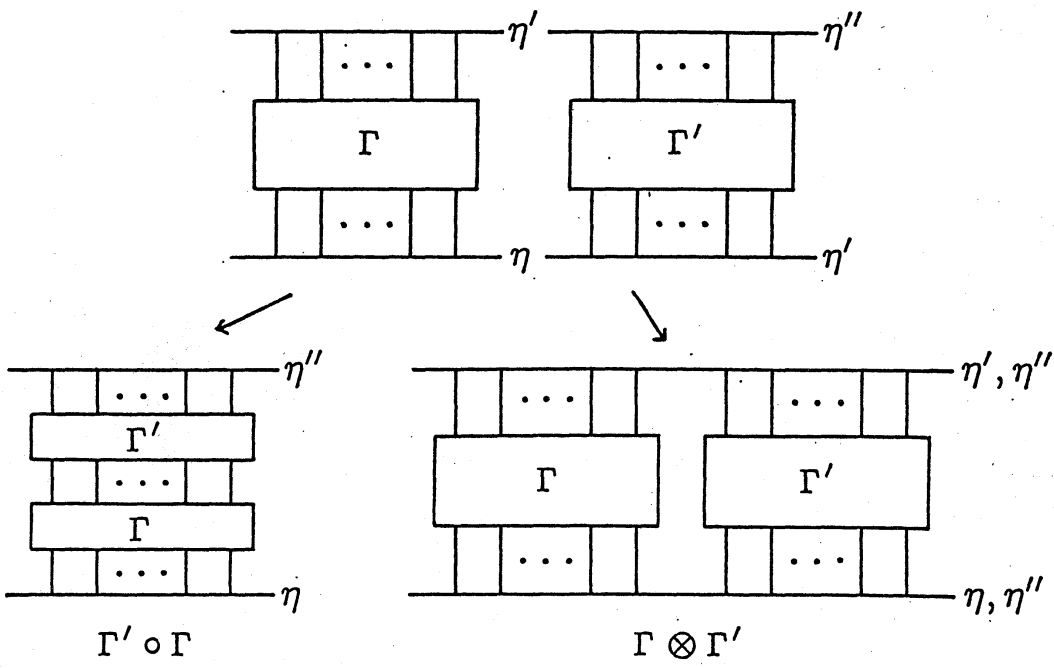

Fig.4

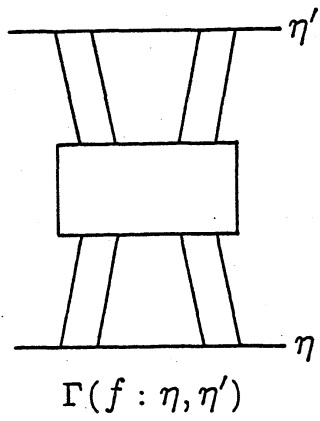

Fig.5

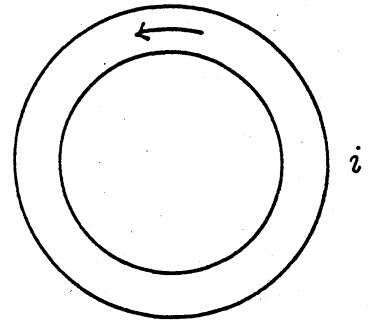
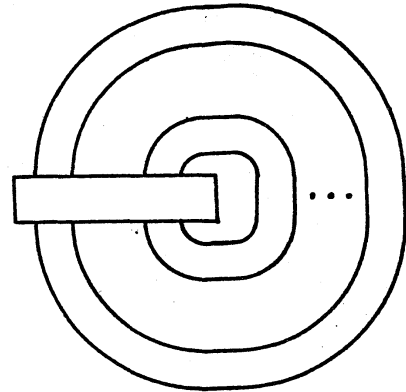
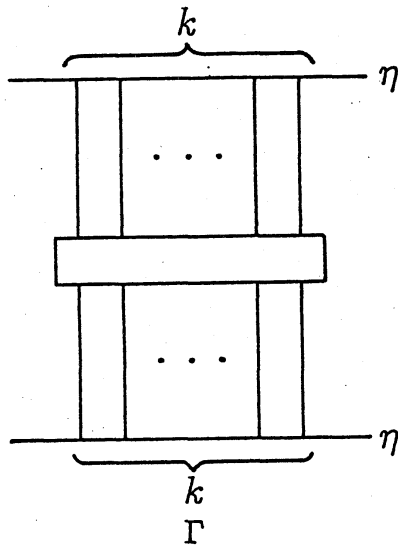

Fig.6



L

Fig.7

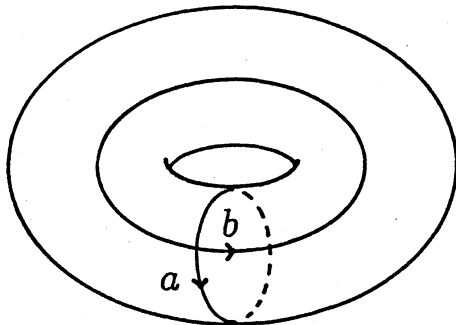

Fig.8

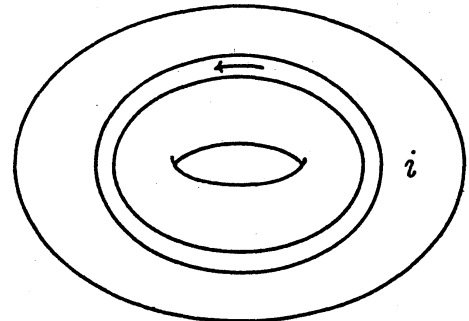

Fig.9

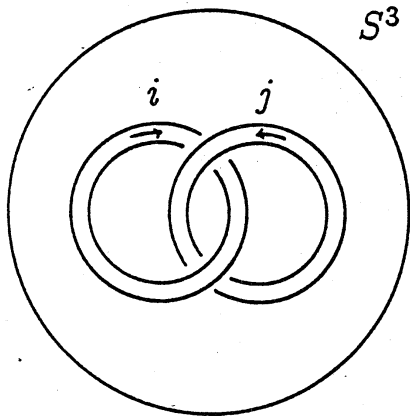

Fig.10

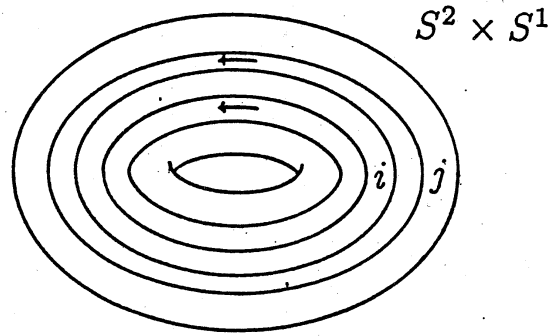

Fig.11

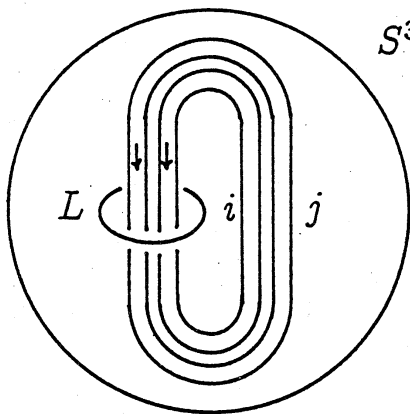

Fig.12a

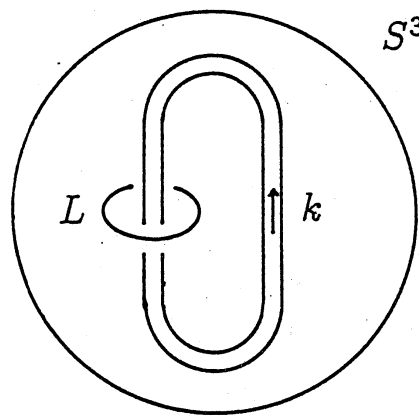

Fig.12b

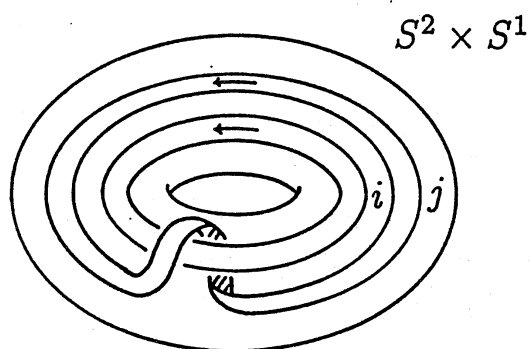

Fig.13

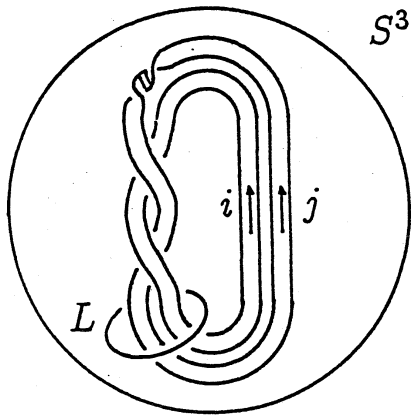

Fig.14a

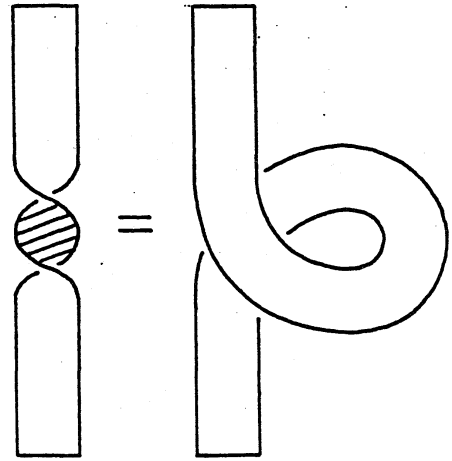

Fig.14b

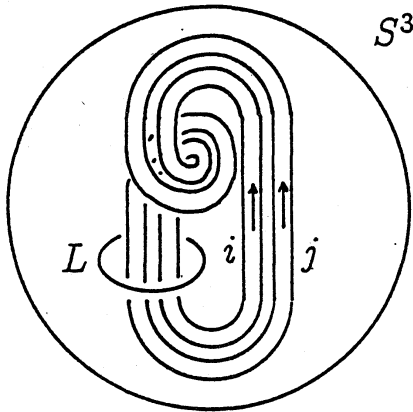

Fig.14c

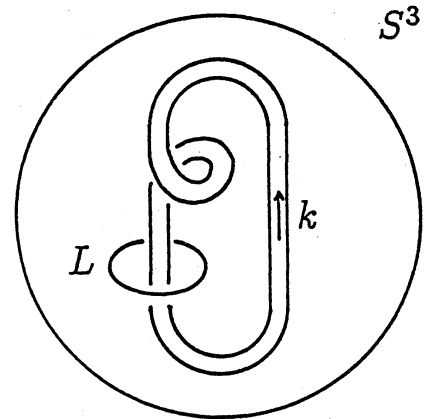

Fig.14d

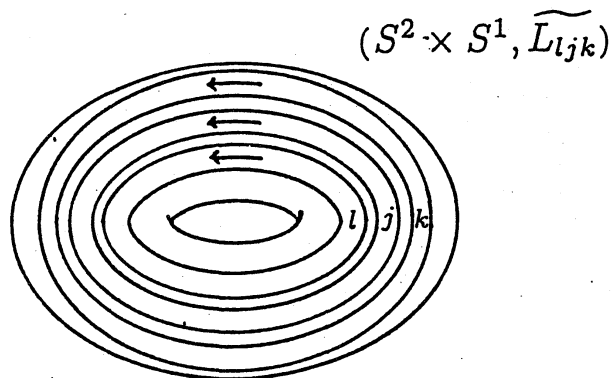

Fig.15

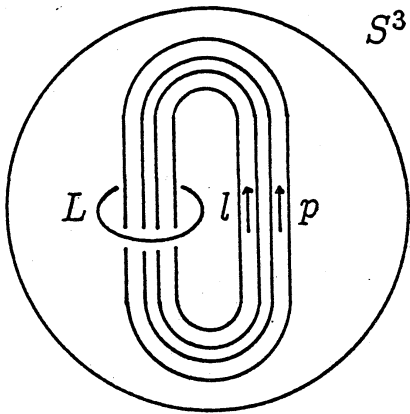

Fig.16b

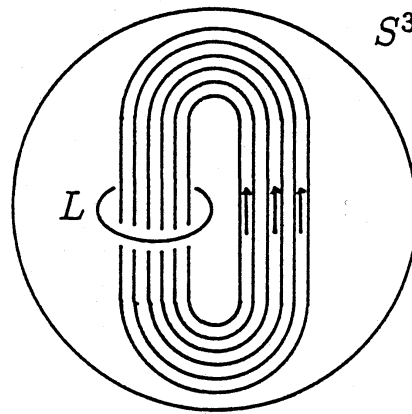

Fig.16a

Fig.17a

Fig.17b

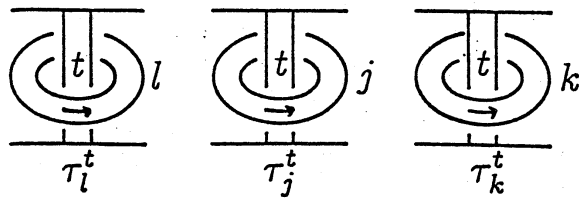
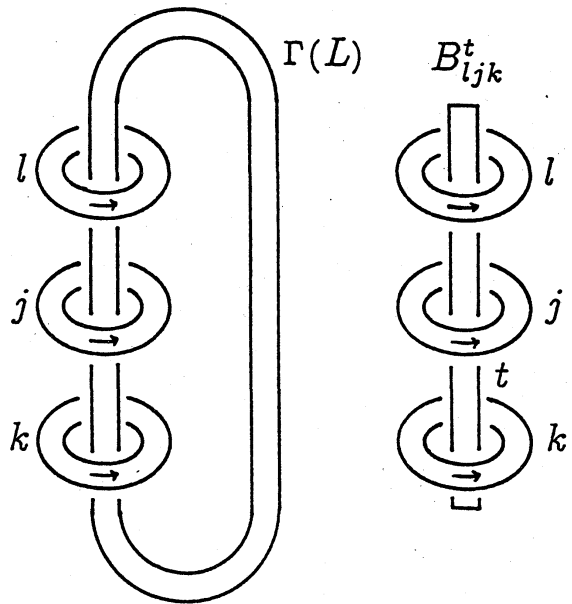

Fig.17c