

Definition of tumor by the loss of stability and functional analytic approach with scale changes for tumor behaviors based on genes

LINFOPS 有限会社 高瀬光雄 (Mitsuo Takase)

LINFOPS Inc.

6-21-1-503 Oukurayama Kouhoku-ku Yokohama 222-0037 Japan

GZL03154@nifty.com

Abstract: Purpose is to know the frame-work mechanism and its equations to explain how a solid tumor grows from the point of view of reverse process of development which means a gradual destruction of a healthy system referring to related genes, and to know their meanings and to search the possibility of a new pathway to tumor treatments. If we try to know the mechanism how to keep the systems of the body constant considering development through the genes network already known, the process will be complex. Here at first the necessary conditions enough to protect the systems of the body are shown considering development, then the function by which the conditions can be implemented in each cell is shown. How the conditions are realized by the genes network is discussed. Solid tumors can be thought to be made losing stability from this mechanism. This is shown using the function and another function in detail. A functional the existence of which may give us information about the situation is also discussed.

1. Introduction

Purpose is to know the frame-work mechanism and its equations to explain how a solid tumor grows from the point of view of reverse process of development which means a gradual destruction of a healthy system referring to related genes, and to know their meanings and to search the possibility of a new pathway to tumor treatments.

If we try to know the mechanism how to keep the systems of the body healthy referring to the genes network already known considering development, the process will be complex.

Here these are conducted and shown as follows.

(1) Necessary conditions for the systems of the body to keep its shape, scale and functions constant are mainly shown referring to genes considering development. This is shown in section 2.

(2) The function by which the conditions are implemented in each cell so as to conduct simulation is shown.

Then how the conditions are realized by the genes network is discussed.

These are shown in section 3.

(3) It is shown for a solid tumor to begin by losing the stability. This is shown in section 4.

- (4) The possibility for a functional to exist which enables an analytic approach with a variable scale for tumor behaviors is discussed. This is shown in section 5.
- (5) As a discussion, especially the possibility of a new pathway to tumor treatments is discussed. This is shown in section 6.

2. Necessary conditions for a healthy local system in the body to keep its shape, scale and functions constant

Each system is thought to be kept constant in its shape, scale and functions. Necessary conditions for a healthy local system of the body to keep its shape and scale are shown in (1) to (3). By (4), the system works functionally. These conditions are thought to be also obtained as aspects in development.

- (1) When cells are lost by like some damage in a system, cells at the local system proliferate like through growth factors.
- (2) When there are too many cells in a part of the system, the growth is inhibited like through apoptosis.
- (3) Isolated cells lose the ability to survive, and in many cases disappear like by apoptosis.
- (4) Each cell has necessary functions for the whole body like the secretion of a hormone.

If conditions (1) and (2) are kept enough stability is kept as explained in section 3.1.1. In a stable system, even if the cells in the system exist fully, when the number of the cells increase even a little, the increase is inhibited not to grow. Here stability is also expressed by $dy/dx < 0$ in Fig.1 as shown in section 3.1.1.

A solid tumor can be begun by losing the stability losing the conditions (1) and (2).

3. The function by which the body cells should proliferate or disappear by apoptosis to protect the systems in the body and relationship between the function and genes

3.1 Consideration about the function in the case of healthy cells which satisfy the conditions

3.1.1 Introduction of a function from conditions (1), (2) and (3)

Conditions (1), (2) and (3) in section 2 can be expressed by the function $f(x)$ in Fig. 1. $f(x)$ has the characters which give conditions (1), (2) and (3), but it has much freedom left except them.

There can be two cases one of which means that x value is the number of contacts of a cell with surrounding cells and materials, the other means that each cell has the information of its location called positional value (ref. 2) in the system to which it belongs.

These are explained as follows.

Conditions (1) and (2) mean the necessity of the existence of stability. A damage is recovered by growth. Too much growth is inhibited. The growth means that the cells increase as a group losing some cells. Here stability means $df(x)/dx < 0$ in Fig.1.

This stability is important not only in keeping the biological body scale and shape constant, but also in technologies and engineering. If there is no stability, the scale and shape will be apt to change and drift.

(1) and (2) are obtained at the point P_s in Fig. 1 where a loss by a damage is recovered by growth, and too much growth is reduced. This is shown more in detail and in a little different manner in section 4.

Condition (3) causes the disappearance of a body cell when it is isolated from a system. This means the apoptosis of the cell. This is expressed by the minus value of the function at $x = 0$.

The conditions (1) ~ (4) are obtained from the necessity to keep a system in a body constant functionally.

At the same time, these conditions are kept through genes and hormones (ref. 1 and 2). So the conditions mean a cross section which connect the genes and the practical necessary conditions, and the essential information thought to be reduced from the network by genes and hormones.

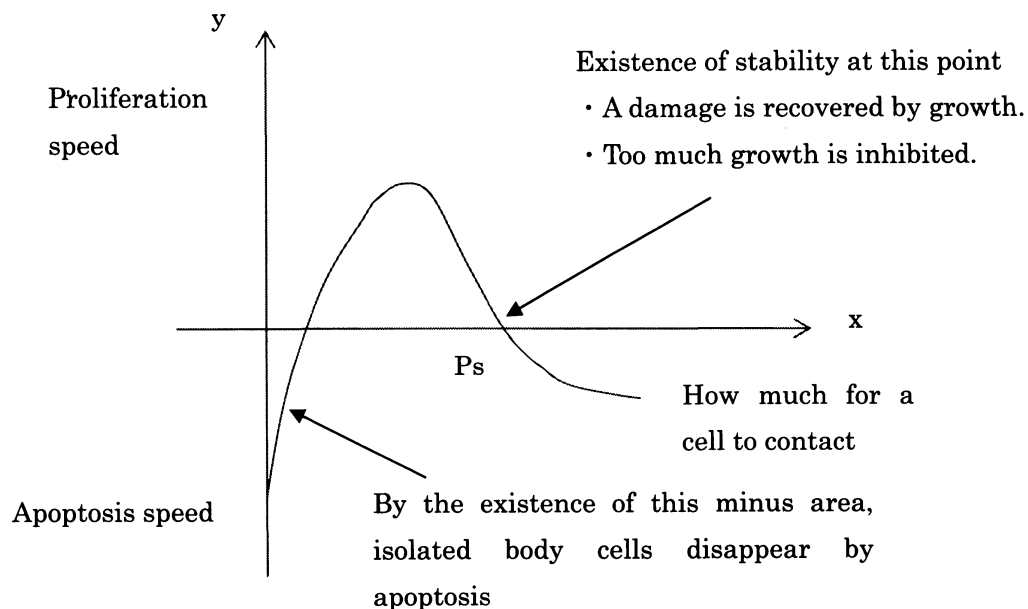

Fig. 1 The function in the case of healthy body cells by which the cells should behave to protect the system

[Relationship with genes which cause conditions (1) and (2)]

Condition (1) is caused through the secretion of growth factors and related genes.

Condition (2) is caused by the lack of contacts by integrins and cadherins(ref. 1 and 2).

The healthy cells are made alive by these contacts. If they lose these contacts and are isolated, they disappear by apoptosis.

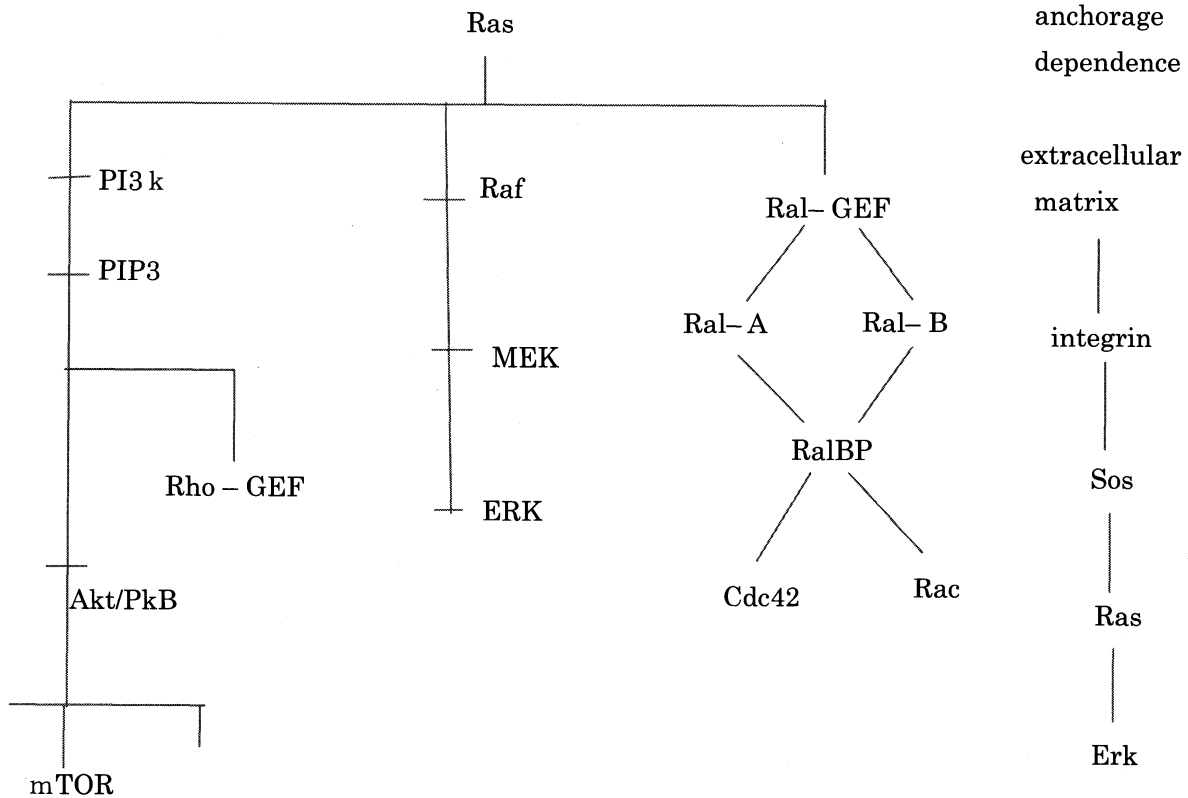

Fig. 2 Gene network element examples which are concerned with growth and anchoring. ras and related genes mainly contribute to cell proliferation.

An integrin which is a molecule to connect and related genes contribute to anchorage dependence.

3.1.2 Loss of stability causing a tumor where isolated tumor cells disappear.

When the function is biased to upper direction along y axis by a gene mutation enough to lose the stability but so as to keep $f(x) < 0$ at $x = 0$, the cells lose the stability but its isolated cells disappear.

The function is shown like by Fig. 3.

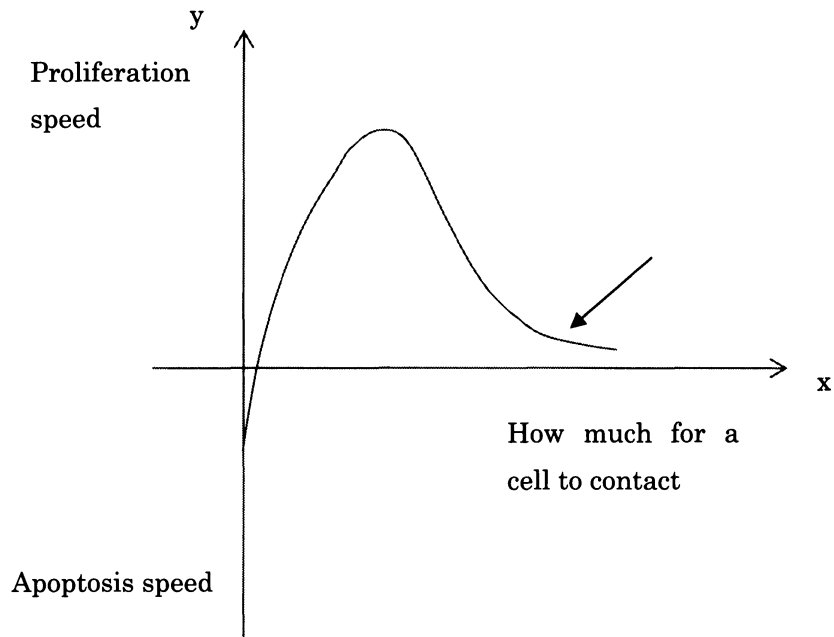

Fig. 3 The function where the stability to keep the scale and the shape constant is lost. A tumor is made. The area is shown by the arrow.

3.1.3 Loss of stability causing a tumor where isolated tumor cells survive

When the function is biased to upper direction along y axis by a gene mutation enough to lose the stability and to become $f(x) > 0$ at $x = 0$, the cells lose the stability and its isolated cells survive as a group.

The function is shown like by Fig. 4.

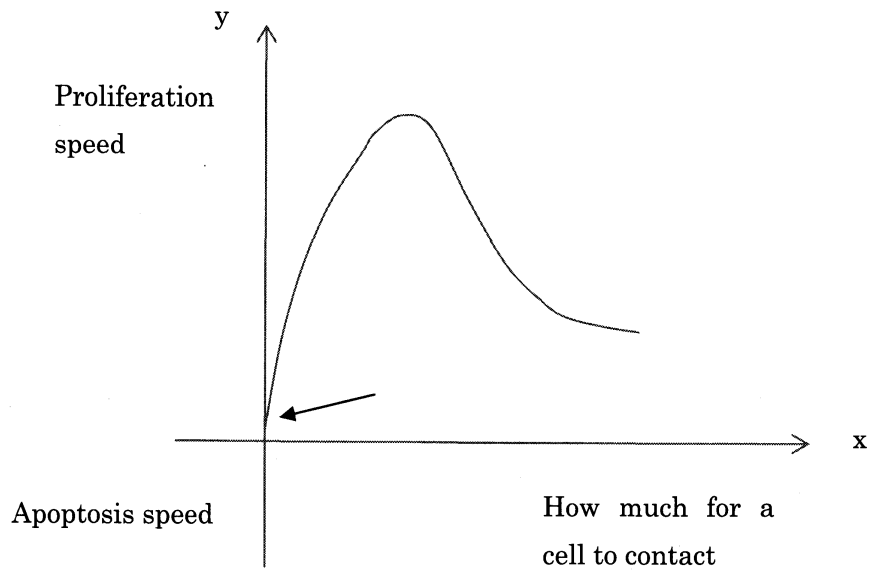

Fig. 4 The function where the stability is lost and isolated cells can survive. The related area is shown by the arrow.
In the case of a tumor, metastasis is thought to be caused more easily.
 $f(x) > 0$ at $x = 0$.

Fig. 1, 3 and 4 are drawn together in Fig. 5 to show the differences.

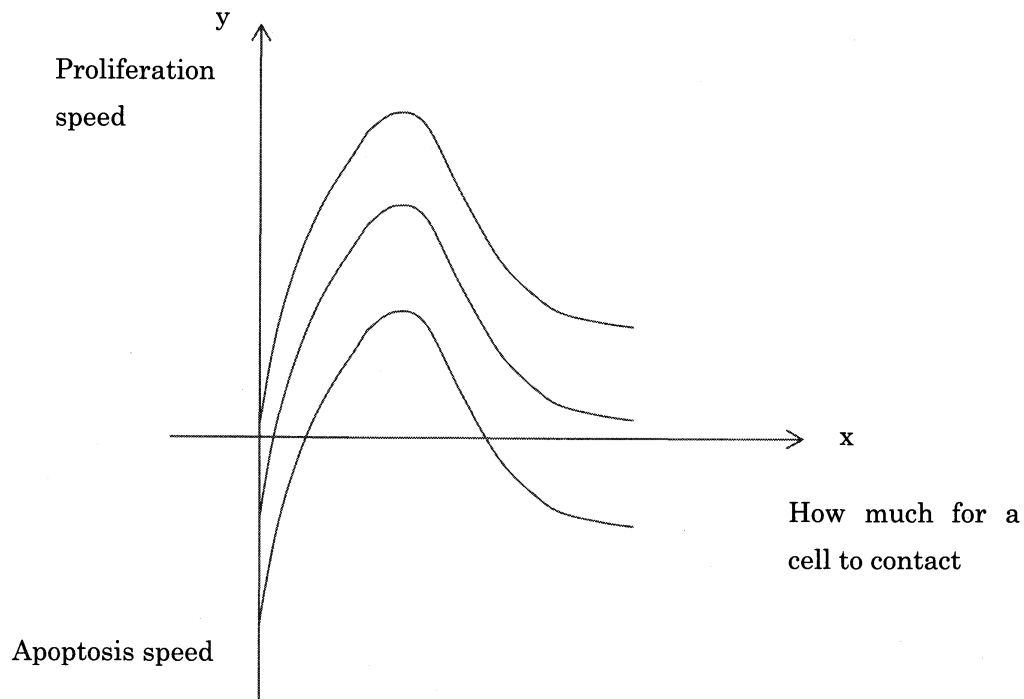

Fig. 5 Fig. 1, 3 and 4 are drawn together here to show the differences.

4. A solid tumor is thought to be begun by losing the stability losing the conditions (1) and (2).

Here, the stability in section 3.1.1 is shown more in detail showing the more concrete tumor states including the states of benign tumors.

It is said that two mutations in DNA, in which the second one may be the loss of P53 function (ref.2), leads to a tumor. Here it is shown that the loss of stability in genes leads to tumors. Tumors can be defined as the loss of stability especially in genes level. This definition of tumors may have a possibility to give us new aspects of of tumors and their treatments. Treatments to lower the proliferation rate of tumor cells are usually conducted like in chemotherapy, but there can be treatments to recover the stability lost in tumors. On the other hand, the followings are said (Ref. 1). The networks in genes are concerned especially with the local growth of each system. Nearly at the highest position of the network hierarchy there may be ras like in Fig. 2, and its too strong activation by a mutation causes an additional activation of many local genes. Especially, the following (1) and (2) are deleted losing the stability making the information from integrins unnecessary. (1) Scaffolding to a different system. The loss of scaffolding by the loss of cells of a system in its boundary like by some damage leads to growth by GF (growth factor). Too much growth at the boundary causes the inhibition of the growth. (2) Isolated cells lose the ability to survive and in many cases die by apoptosis. Then benign tumors are produced by a weak additional growth, but the stability is kept. When the growth becomes excessively big, the stability is lost. Then the necessity of scaffolding is lost, and isolated cells can survive, and the number of such mutated cells grow without any limitation. Fig. 6 shows the original stability and the limit of its loss by the bias given by like ras making the area of benign tumors in the midst..

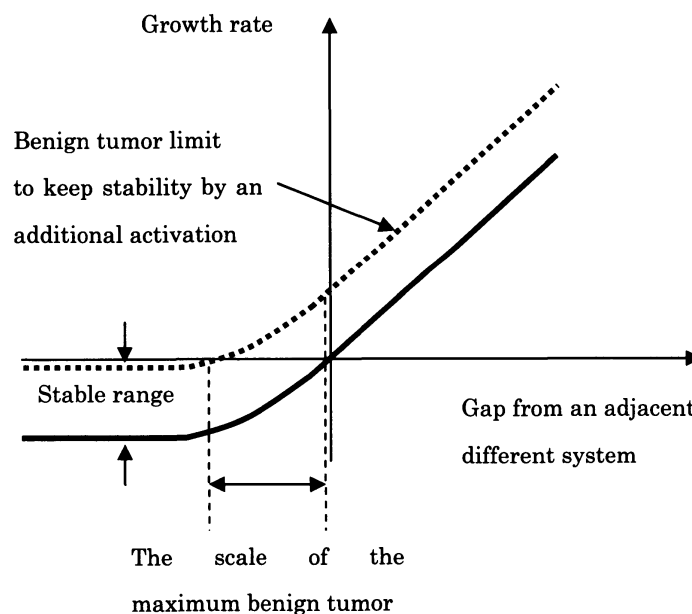

Fig. 6 The mechanism of stability and loss of stability, and the range of benign tumor

5. Functional analytic approach with a variable scale for tumor behaviors

When a local system is in a healthy state not in illness, each cell in a local system is thought to be biologically most stable with the nearly least apoptosis and the nearly least proliferation consuming the nearly least energy in the cell.

Moreover, it is inferred that there will be a functional with many independent variables like the scale, shape and functions like the secretion of a hormone, which come from the gene expression, in each of systems in a body. Then the functional concentrates minimizing its value into the body made from development. This may correspond to the least biological energy to certain extent.

In the system of the body, the total binding energy of the cells and materials is thought to be maximized.

A functional can be made not only by the total binding energy, but also the other elements shown above.

When tumor cells add to the local system, the tumor cells have more or less the characteristics of weaker connection, faster cell cycle and degrees of apoptosis changing the characteristics of cells in the analytic region. These characteristics are based on a mutation in genes like ras. These relationships between the characteristics and genes can be shown to a certain extent.

The state of types of connections about a system in a body is shown in Fig. 7. There, inner cells are connected by cadherins or gap junctions generally.

The system is connected with an adjacent outer system by integrins generally.

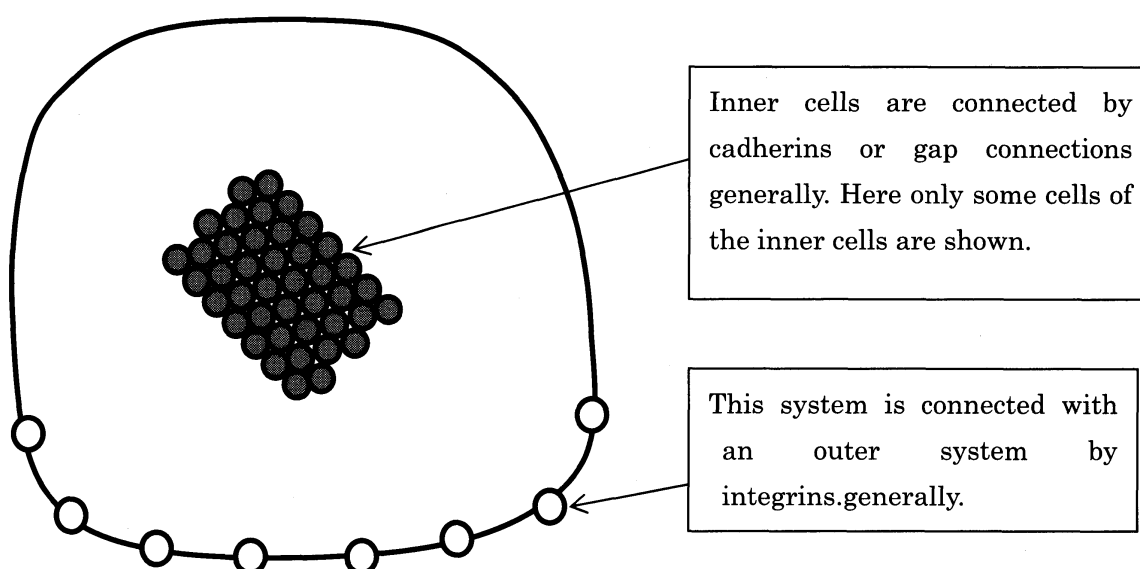

Fig. 7 The state of types of connections about a general system in a body

$U = \sum_i u_i / 2$ 1/2 is applied only to cell-cell bindings.

u_i ····total binding energy of cell i with other cells including cells or materials of an outer system of the system

6. Discussion

The mechanism and the function for each cell to keep scale and shape constant have been introduced referring to genes. This can be thought to be a simplified and necessary one to protect a system.

Tumors can be made losing the characteristics especially the stability in the mechanism.

In therapies of tumors, for example, a treatment to delete tumor cells by using the difference of proliferation speeds between tumor cells and healthy cells is applied. But tumor growth can be inhibited by recovering the stability shown in section 3.1.1. In drugs like Imatinib in the targeted therapy, a mutated strengthened gene like ras is weakened so as to be corrected. But this can be considered to recover the lost stability of tumor cells weakening the growth tendency of genes like a strengthened genes by a mutation.

References

1. Robert A. Weinberg. the biology of cancer. Garland Science.
2. Bruce Alberts et al. Molecular biology of the cell. Garland Publishing Inc.