

Near-critical percolation in two dimensions

Pierre Nolin*

École Normale Supérieure[†] and Université Paris-Sud[‡]

Email: pierre.nolin@ens.fr

<http://www.dma.ens.fr/~nolin>

Abstract

We give a self-contained and detailed presentation of Kesten's results that allow to relate critical and near-critical percolation on the triangular lattice. They constitute an important step in the derivation of the exponents describing the near-critical behavior of this model. For future use and reference, we also show how these results can be obtained in more general situations, and we state some new consequences.

Key words: Near-critical percolation, arm events, critical exponents.

AMS 2000 Subject Classification: Primary 60K35; Secondary: 82B43, 82B27.

Submitted to EJP on January 11, 2008, final version accepted July 17, 2008.

*Research supported by the Agence Nationale pour la Recherche under the grant ANR-06-BLAN-0058

[†]Département de Mathématiques et Applications, École Normale Supérieure, 45 rue d'Ulm, 75230 Paris Cedex 05, France

[‡]Laboratoire de Mathématiques, Bâtiment 425, Université Paris-Sud 11, 91405 Orsay Cedex, France

1 Introduction

Since 2000, substantial progress has been made on the mathematical understanding of percolation on the triangular lattice. In fact, it is fair to say that it is now well-understood. Recall that performing a percolation with parameter p on a lattice means that each site is chosen independently to be black with probability p and white with probability $1 - p$. We then look at the connectivity properties of the set of black sites (or the set of white ones). It is well-known that on the regular triangular lattice, when $p \leq 1/2$ there is almost surely no infinite black connected component, whereas when $p > 1/2$ there is almost surely one infinite black connected component. Its mean density can then be measured via the probability $\theta(p)$ that a given site belongs to this infinite black component.

Thanks to Smirnov's proof of conformal invariance of the percolation model at $p = 1/2$ [46], allowing to prove that critical percolation interfaces converge toward SLE_6 as the mesh size goes to zero, and to the derivation of the SLE_6 critical exponents [34; 35] by Lawler, Schramm and Werner, it is possible to prove results concerning the behavior of the model when p is exactly equal to $1/2$, that had been conjectured in the physics literature, such as the values of the arm exponents [47; 36]. See e.g. [49] for a survey and references.

More than ten years before the above-mentioned papers, Kesten had shown in his 1987 paper *Scaling relations for 2D-percolation* [31] that the behavior of percolation at criticality (ie when $p = 1/2$) and near criticality (ie when p is close to $1/2$) are very closely related. In particular, the exponents that describe the behavior of quantities such as $\theta(p)$ when $p \rightarrow 1/2^+$ and the arm exponents for percolation at $p = 1/2$ are related via relations known as scaling (or hyperscaling) relations. At that time, it was not proved that any of the exponents existed (not to mention their actual value) and Kesten's paper explains how the knowledge of the existence and the values of some arm exponents allows to deduce the existence and the value of the exponents that describe "near-critical" behavior. Therefore, by combining this with the derivation of the arm exponents, we can for instance conclude [47] that $\theta(p) = (p - 1/2)^{5/36+o(1)}$ as $p \rightarrow 1/2^+$.

The first goal of the present paper is to give a complete self-contained proof of Kesten's results that are used to describe near-critical percolation. Some parts of the proofs are simplified by using the so-called 5-arm exponent and Reimer's inequality. We hope that this will be useful and help a wider community to have a clear and complete picture of this model.

It is also worth emphasizing that the proofs contain techniques (such as separation lemmas for arms) that are interesting in themselves and that can be applied to other situations. The second main purpose of the present paper is to state results in a more general setting than in [31], for possible future use. In particular, we will see that the "uniform estimates below the characteristic length" hold for an arbitrary number of arms and non-homogeneous percolation (see Theorem 11 on separation of arms, and Theorem 27 on arm events near criticality). Some technical difficulties arise due to these generalizations, but these new statements turn out to be useful. They are for instance instrumental in our study of gradient percolation in [39]. Other new statements in the present paper concern arms "with defects" or the fact that the finite-size scaling characteristic length $L_\epsilon(p)$ remains of the same order of magnitude when ϵ varies in $(0, 1/2)$ (Corollary 37) – and not only for ϵ small enough. This last fact is used in [40] to study the "off-critical" regime for percolation.

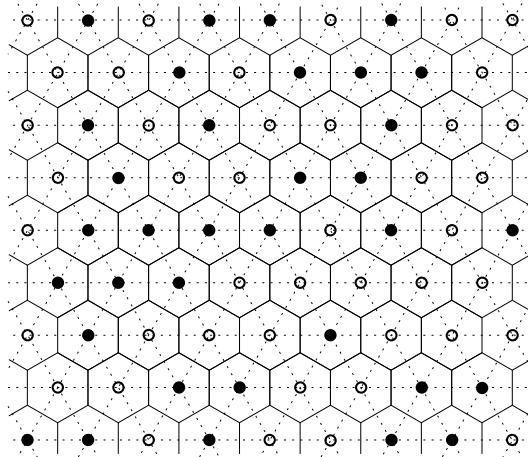

Figure 1: Percolation on the triangular lattice can be viewed as a random coloring of the dual hexagonal lattice.

2 Percolation background

Before turning to near-critical percolation in the next section, we review some general notations and properties concerning percolation. We also sketch the proof of some of them, for which small generalizations will be needed. We assume the reader is familiar with the standard fare associated with percolation, and we refer to the classic references [27; 23] for more details.

2.1 Notations

Setting

Unless otherwise stated, we will focus on site percolation in two dimensions, on the triangular lattice. This lattice will be denoted by $\mathbb{T} = (\mathbb{V}^T, \mathbb{E}^T)$, where \mathbb{V}^T is the set of vertices (or “sites”), and \mathbb{E}^T is the set of edges (or “bonds”), connecting adjacent sites. We restrict ourselves to this lattice because it is at present the only one for which the critical regime has been proved to be conformal invariant in the scaling limit.

The usual (homogeneous) site percolation process of parameter p can be defined by taking the different sites to be *black* (or occupied) with probability p , and *white* (vacant) with probability $1 - p$, independently of each other. This gives rise to a product probability measure on the set of configurations, which is referred to as \mathbb{P}_p , the corresponding expectation being \mathbb{E}_p . We usually represent it as a random (black or white) coloring of the faces of the dual hexagonal lattice (see Figure 1).

More generally, we can associate to each family of parameters $\hat{p} = (\hat{p}_v)_v$ a product measure $\hat{\mathbb{P}}$ for which each site v is black with probability \hat{p}_v and white with probability $1 - \hat{p}_v$, independently of all other sites.

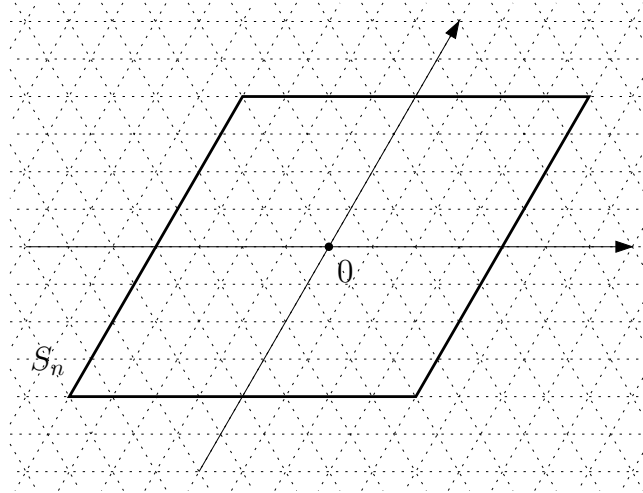

Figure 2: We refer to oblique coordinates, and we denote by S_n the “box of size n ”.

Coordinate system

We sometimes use complex numbers to position points in the plane, but we mostly use oblique coordinates, with the origin in 0 and the basis given by 1 and $e^{i\pi/3}$, ie we take the x -axis and its image under rotation of angle $\pi/3$ (see Figure 2). For $a_1 \leq a_2$ and $b_1 \leq b_2$, the parallelogram R of corners $a_j + b_k e^{i\pi/3}$ ($j, k = 1, 2$) is thus denoted by $[a_1, a_2] \times [b_1, b_2]$, its interior being $\mathring{R} :=]a_1, a_2[\times]b_1, b_2[= [a_1 + 1, a_2 - 1] \times [b_1 + 1, b_2 - 1]$ and its boundary $\partial R := R \setminus \mathring{R}$ the concatenation of the four boundary segments $\{a_i\} \times [b_1, b_2]$ and $[a_1, a_2] \times \{b_i\}$.

We denote by $\|z\|_\infty$ the infinity norm of a vertex z as measured with respect to these two axes, and by d the associated distance. For this norm, the set of points at distance at most N from a site z forms a rhombus $S_N(z)$ centered on this site and whose sides line up with the basis axes. Its boundary, the set of points at distance exactly N , is denoted by $\partial S_N(z)$, and its interior, the set of points at distance strictly less than N , by $\mathring{S}_N(z)$. To describe the percolation process, we often use $S_N := S_N(0)$ and call it the “box of size N ”. Note that it can also be written as $S_N = [-N, N] \times [-N, N]$. It will sometimes reveal useful to have noted that

$$|S_N(z)| \leq C_0 N^2 \tag{2.1}$$

for some universal constant C_0 . For any two positive integers $n \leq N$, we also consider the annulus $S_{n,N}(z) := S_N(z) \setminus \mathring{S}_n(z)$, with the natural notation $S_{n,N} := S_{n,N}(0)$.

Connectivity properties

Two sites x and y are said to be connected if there exists a black path, ie a path consisting only of black sites, from x to y . We denote it by $x \rightsquigarrow y$. Similarly, if there exists a white path from x to y , these two sites are said to be $*$ -connected, which we denote by $x \rightsquigarrow^* y$.

For notational convenience, we allow y to be “ ∞ ”: we say that x is connected to infinity ($x \rightsquigarrow \infty$)

if there exists an infinite, self-avoiding and black path starting from x . We denote by

$$\theta(p) := \mathbb{P}_p(0 \rightsquigarrow \infty) \tag{2.2}$$

the probability for 0 (or any other site by translation invariance) to be connected to ∞ .

To study the connectivity properties of a percolation realization, we often are interested in the connected components of black or white sites: the set of black sites connected to a site x (empty if x is white) is called the cluster of x , denoted by $C(x)$. We can define similarly $C^*(x)$ the white cluster of x . Note that $x \rightsquigarrow \infty$ is equivalent to the fact that $|C(x)| = \infty$.

If A and B are two sets of vertices, the notation $A \rightsquigarrow B$ is used to denote the event that some site in A is connected to some site in B . If the connection is required to take place using exclusively the sites in some other set C , we write $A \overset{C}{\rightsquigarrow} B$.

Crossings

A left-right (or horizontal) crossing of the parallelogram $[a_1, a_2] \times [b_1, b_2]$ is simply a black path connecting its left side to its right side. However, this definition implies that the existence of a crossing in two boxes sharing just a side are not completely independent: it will actually be more convenient to relax (by convention) the condition on its extremities. In other words, we request such a crossing path to be composed only of sites in $]a_1, a_2[\times]b_1, b_2[$ which are black, with the exception of its two extremities on the sides of the parallelogram, which can be either black or white. The existence of such a horizontal crossing is denoted by $\mathcal{C}_H([a_1, a_2] \times [b_1, b_2])$. We define likewise top-bottom (or vertical) crossings and denote their existence by $\mathcal{C}_V([a_1, a_2] \times [b_1, b_2])$, and also white crossings, the existence of which we denote by \mathcal{C}_H^* and \mathcal{C}_V^* .

More generally, the same definition applies for crossings of annuli $S_{n,N}(z)$, from the internal boundary $\partial S_n(z)$ to the external one $\partial S_N(z)$, or even in more general domains \mathcal{D} , from one part of the boundary to another part.

Asymptotic behavior

We use the standard notations to express that two quantities are asymptotically equivalent. For two positive functions f and g , the notation $f \asymp g$ means that f and g remain of the same order of magnitude, in other words that there exist two positive and finite constants C_1 and C_2 such that $C_1 g \leq f \leq C_2 g$ (so that the ratio between f and g is bounded away from 0 and $+\infty$), while $f \approx g$ means that $\log f / \log g \rightarrow 1$ (“logarithmic equivalence”) – either when $p \rightarrow 1/2$ or when $n \rightarrow \infty$, which will be clear from the context. This weaker equivalence is generally the one obtained for quantities behaving like power laws.

2.2 General properties

On the triangular lattice, it is known since [26] that percolation features a phase transition at $p = 1/2$, called the *critical point*: this means that

- When $p < 1/2$, there is (a.s.) no infinite cluster (*sub-critical regime*), or equivalently $\theta(p) = 0$.

- When $p > 1/2$, there is (a.s.) an infinite cluster (*super-critical regime*), or equivalently $\theta(p) > 0$. Furthermore, the infinite cluster turns out to be *unique* in this case.

In sub- and super-critical regimes, “correlations” decay very fast, this is the so-called *exponential decay* property:

- For any $p < 1/2$,

$$\exists C_1, C_2(p) > 0, \quad \mathbb{P}_p(0 \rightsquigarrow \partial S_n) \leq C_1 e^{-C_2(p)n}.$$

- We can deduce from it that for any $p > 1/2$,

$$\begin{aligned} \mathbb{P}_p(0 \rightsquigarrow \partial S_n, |C(0)| < \infty) \\ \leq \mathbb{P}_p(\exists \text{ white circuit surrounding } 0 \text{ and a site on } \partial S_n) \\ \leq C'_1 e^{-C'_2(p)n} \end{aligned}$$

for some $C'_1(p), C'_2(p) > 0$.

We would like to stress the fact that the speed at which these correlations vanish is governed by a constant C_2 which depends on p – it becomes slower and slower as p approaches $1/2$. To study what happens near the critical point, we need to control this speed for different values of p : we will derive in Section 7.4 an exponential decay property that is uniform in p .

The intermediate regime at $p = 1/2$ is called the *critical regime*. It is known for the triangular lattice that there is no infinite cluster at criticality: $\theta(1/2) = 0$. Hence to summarize,

$$\theta(p) > 0 \quad \text{iff} \quad p > 1/2.$$

Correlations no longer decay exponentially fast in this critical regime, but (as we will see) just like power laws. For instance, non trivial random scaling limits – with fractal structures – arise. This particular regime has some very strong symmetry property (conformal invariance) which allows to describe it very precisely.

2.3 Some technical tools

Monotone events

We use the standard terminology associated with events: an event A is increasing if “it still holds when we add black sites”, and decreasing if it satisfies the same property, but when we add white sites.

Recall also the usual coupling of the percolation processes for different values of p : we associate to the different sites x i.i.d. random variables U_x uniform on $[0, 1]$, and for any p , we obtain the measure \mathbb{P}_p by declaring each site x to be black if $U_x \leq p$, and white otherwise. This coupling shows for instance that

$$p \mapsto \mathbb{P}_p(A)$$

is a non-decreasing function of p when A is an increasing event. More generally, we can represent in this way any product measure $\hat{\mathbb{P}}$.

Correlation inequalities

The two most common inequalities for percolation concern monotone events: if A and B are increasing events, we have ([5; 23])

1. the Harris-FKG inequality:

$$\mathbb{P}(A \cap B) \geq \mathbb{P}(A)\mathbb{P}(B).$$

2. the BK inequality:

$$\mathbb{P}(A \circ B) \leq \mathbb{P}(A)\mathbb{P}(B)$$

if A and B depend only on sites in a finite set, $A \circ B$ meaning as usual that A and B occur “disjointly”.

In the paper [5] where they proved the BK inequality, Van den Berg and Kesten also conjectured that this inequality holds in a more general fashion, for any pair of events A and B (depending on a finite number of sites): if we define $A \square B$ the disjoint occurrence of A and B in this situation, we have

$$\mathbb{P}(A \square B) \leq \mathbb{P}(A)\mathbb{P}(B). \quad (2.3)$$

This was later proved by Reimer [42], and it is now known as Reimer’s inequality. We will also use the following inequality:

$$\mathbb{P}_{1/2}(A \circ B) \leq \mathbb{P}_{1/2}(A \cap \tilde{B}), \quad (2.4)$$

where \tilde{B} is the event obtained by “flipping” the configurations in B . This inequality is an intermediate step in Reimer’s proof. On this subject, the reader can consult the nice review [8].

Russo’s formula

Russo’s formula allows to study how probabilities of events vary when the percolation parameter p varies. Recall that for an increasing event A , the event “ v is pivotal for A ” is composed of the configurations ω such that if we make v black, A occurs, and if we make it white, A does not occur. Note that by definition, this event is independent of the particular state of v . An analog definition applies for decreasing events.

Theorem 1 (Russo’s formula). *Let A be an increasing event, depending only on the sites contained in some finite set S . Then*

$$\frac{d}{dp} \mathbb{P}_p(A) = \sum_{v \in S} \mathbb{P}_p(v \text{ is pivotal for } A). \quad (2.5)$$

We now quickly remind the reader how to prove this formula, since we will later (in Section 6) generalize it a little.

Proof. We allow the parameters \hat{p}_v ($v \in S$) to vary independently, which amounts to consider the more general function $\mathcal{P} : \hat{p} = (\hat{p}_v)_{v \in S} \mapsto \hat{\mathbb{P}}(A)$. This is clearly a smooth function (it is polynomial), and $\mathbb{P}_p(A) = \mathcal{P}(p, \dots, p)$. Now using the standard coupling, we see that for any site w , for a small variation $\epsilon > 0$ in w ,

$$\hat{\mathbb{P}}^{p+\epsilon}(A) - \hat{\mathbb{P}}(A) = \epsilon \times \hat{\mathbb{P}}(w \text{ is pivotal for } A), \quad (2.6)$$

so that

$$\frac{\partial}{\partial \hat{p}_w} \hat{\mathbb{P}}(A) = \hat{\mathbb{P}}(w \text{ is pivotal for } A).$$

Russo's formula now follows readily by expressing $\frac{d}{dp} \mathbb{P}_p(A)$ in terms of the previous partial derivatives:

$$\begin{aligned} \frac{d}{dp} \mathbb{P}_p(A) &= \sum_{v \in S} \left(\frac{\partial}{\partial \hat{p}_v} \hat{\mathbb{P}}(A) \right)_{\hat{p}=(p, \dots, p)} \\ &= \sum_{v \in S} \mathbb{P}_p(v \text{ is pivotal for } A). \end{aligned}$$

□

Russo-Seymour-Welsh theory

For symmetry reasons, we have:

$$\forall n, \quad \mathbb{P}_{1/2}(\mathcal{C}_H([0, n] \times [0, n])) = 1/2. \quad (2.7)$$

In other words, the probability of crossing an $n \times n$ box is the same on every scale. In particular, this probability is bounded from below: this is the starting point of the so-called Russo-Seymour-Welsh theory (see [23; 27]), that provides lower bounds for crossings in parallelograms of fixed aspect ratio $\tau \times 1$ ($\tau \geq 1$) in the “hard direction”.

Theorem 2 (Russo-Seymour-Welsh). *There exist universal non-decreasing functions $f_k(\cdot)$ ($k \geq 2$), that stay positive on $(0, 1)$ and verify: if for some parameter p the probability of crossing an $n \times n$ box is at least δ_1 , then the probability of crossing a $kn \times n$ parallelogram is at least $f_k(\delta_1)$. Moreover, these functions can be chosen satisfying the additional property: $f_k(\delta) \rightarrow 1$ as $\delta \rightarrow 1$, with $f_k(1 - \epsilon) = 1 - C_k \epsilon^{\alpha_k} + o(\epsilon^{\alpha_k})$ for some $C_k, \alpha_k > 0$.*

If for instance $p > 1/2$, we know that when n gets very large, the probability δ_1 of crossing an $n \times n$ rhombus becomes closer and closer to 1, and the additional property tells that the probability of crossing a $kn \times n$ parallelogram tends to 1 as a function of δ_1 .

Combined with Eq.(2.7), the theorem implies:

Corollary 3. *For each $k \geq 1$, there exists some $\delta_k > 0$ such that*

$$\forall n, \quad \mathbb{P}_{1/2}(\mathcal{C}_H([0, kn] \times [0, n])) \geq \delta_k. \quad (2.8)$$

Note that only going from rhombi to parallelograms of aspect ratio slightly larger than 1 is difficult. For instance, once the result is known for $2n \times n$ parallelograms, the construction of Figure 3 shows that we can take

$$f_k(\delta) = \delta^{k-2} (f_2(\delta))^{k-1}. \quad (2.9)$$

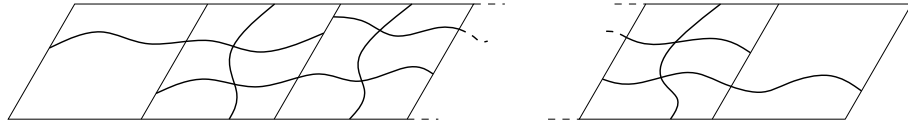

Figure 3: This construction shows that we can take $f_k(\delta) = \delta^{k-2}(f_2(\delta))^{k-1}$.

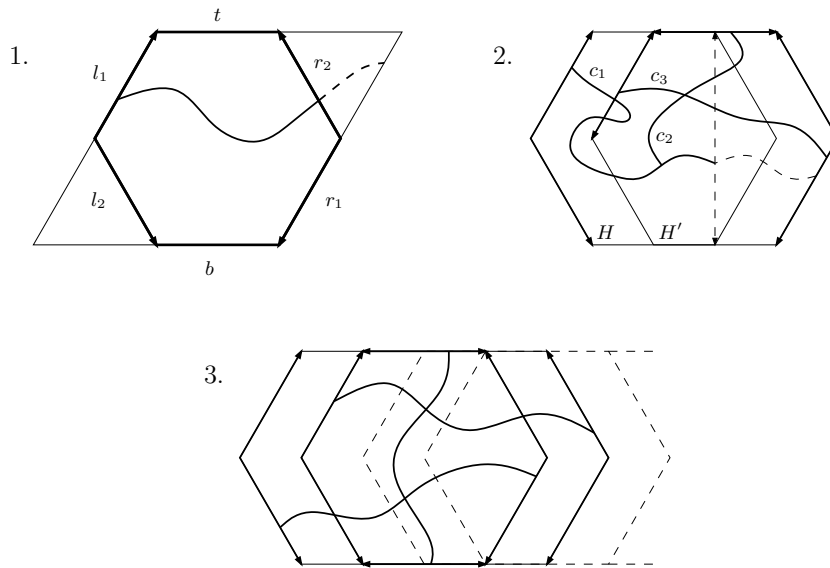

Figure 4: Proof of the RSW theorem on the triangular lattice.

Proof. The proof goes along the same lines as the one given by Grimmett [23] for the square lattice. We briefly review it to indicate the small adaptations to be made on the triangular lattice. We hope Figure 4 will make things clear. For an account on RSW theory in a general setting, the reader should consult Chapter 6 of [27].

We work with hexagons, since they exhibit more symmetries. Note that a crossing of an $N \times N$ rhombus induces a left-right crossing of a hexagon of side length $N/2$ (see Figure 4.1). We then apply the “square-root trick” – used recurrently during the proof – to the four events $\{l_i \rightsquigarrow r_j\}$: one of them occurs with probability at least $1 - (1 - \delta)^{1/4}$. This implies that

$$\mathbb{P}(l_1 \rightsquigarrow r_1) = \mathbb{P}(l_2 \rightsquigarrow r_2) \geq (1 - (1 - \delta)^{1/4})^2 =: \tau(\delta). \quad (2.10)$$

(if $\mathbb{P}(l_1 \rightsquigarrow r_1) = \mathbb{P}(l_2 \rightsquigarrow r_2) \geq 1 - (1 - \delta)^{1/4}$ we are OK, otherwise we just combine a crossing $l_1 \rightsquigarrow r_2$ and a crossing $l_2 \rightsquigarrow r_1$).

Now take two hexagons H, H' as on Figure 4.2 (with obvious notation for their sides). With probability at least $1 - (1 - \delta)^{1/2}$ there exists a left-right crossing in H whose last intersection with $l'_1 \cup l'_2$ is on l'_2 . Assume this is the case, and condition on the lowest left-right crossing in H : with probability at least $1 - (1 - \tau(\delta))^{1/2}$ it is connected to t' in H' . We then use a crossing from l'_1 to $r'_1 \cup r'_2$, occurring with probability at least $1 - (1 - \delta)^{1/2}$, to obtain

$$\mathbb{P}(l_1 \cup l_2 \rightsquigarrow r'_1 \cup r'_2) \geq (1 - (1 - \delta)^{1/2}) \times (1 - (1 - \tau(\delta))^{1/2}) \times (1 - (1 - \delta)^{1/2}).$$

The hard part is done: it now suffices to use t successive “longer hexagons”, and $t - 1$ top-bottom crossings of regular hexagons, for t large enough (see Figure 4.3). We construct in such a way a left right-crossing of a $2N \times N$ parallelogram, with probability at least

$$f_2(\delta) := (1 - (1 - \delta)^{1/2})^{2t} (1 - (1 - \tau(\delta))^{1/2})^{2t-1}. \quad (2.11)$$

When δ tends to 1, $\tau(\delta)$, and thus $f_2(\delta)$, also tend to 1. Moreover, it is not hard to convince oneself that f_2 admits near $\delta = 1$ an asymptotic development of the form

$$f_2(1 - \epsilon) = 1 - C\epsilon^{1/8} + o(\epsilon^{1/8}). \quad (2.12)$$

Eq.(2.9) then provides the desired conclusion for any $k \geq 2$. □

3 Near-critical percolation overview

3.1 Characteristic length

We will use throughout the paper a certain “characteristic length” $L(p)$ defined in terms of crossing probabilities, or “sponge-crossing probabilities”. This length is often convenient to work with, and it has been used in many papers concerning finite-size scaling, e.g. [15; 16; 6; 7].

Consider the rhombi $[0, n] \times [0, n]$. At $p = 1/2$, $\mathbb{P}_p(\mathcal{C}_H([0, n] \times [0, n])) = 1/2$. When $p < 1/2$ (sub-critical regime), this probability tends to 0 when n goes to infinity, and it tends to 1 when $p > 1/2$ (super-critical regime). We introduce a quantity that measures the scale up to which these crossing probabilities remain bounded away from 0 and 1: for each $\epsilon \in (0, 1/2)$, we define

$$L_\epsilon(p) = \begin{cases} \min\{n \text{ s.t. } \mathbb{P}_p(\mathcal{C}_H([0, n] \times [0, n])) \leq \epsilon\} & \text{when } p < 1/2, \\ \min\{n \text{ s.t. } \mathbb{P}_p(\mathcal{C}_H^*([0, n] \times [0, n])) \leq \epsilon\} & \text{when } p > 1/2. \end{cases} \quad (3.1)$$

Hence by definition,

$$\mathbb{P}_p(\mathcal{C}_H([0, L_\epsilon(p) - 1] \times [0, L_\epsilon(p) - 1])) \geq \epsilon \quad (3.2)$$

and

$$\mathbb{P}_p(\mathcal{C}_H([0, L_\epsilon(p)] \times [0, L_\epsilon(p)])) \leq \epsilon \quad (3.3)$$

if $p < 1/2$, and the same with $*$'s if $p > 1/2$.

Note that by symmetry, we also have directly $L_\epsilon(p) = L_\epsilon(1 - p)$. Since $\mathbb{P}_{1/2}(\mathcal{C}_H([0, n] \times [0, n]))$ is equal to $1/2$ on every scale, we will take the convention $L_\epsilon(1/2) = +\infty$, so that in the following, the expression “for any $n \leq L_\epsilon(p)$ ” must be interpreted as “for any n ” when $p = 1/2$. This convention is also consistent with the following property.

Proposition 4. *For any fixed $\epsilon \in (0, 1/2)$, $L_\epsilon(p) \rightarrow +\infty$ when $p \rightarrow 1/2$.*

Proof. Was it not the case, we could find an integer N and a sequence $p_k \rightarrow 1/2$, say $p_k < 1/2$, such that for each k , $L_\epsilon(p_k) = N$, which would imply

$$\mathbb{P}_{p_k}(\mathcal{C}_H([0, N] \times [0, N])) \leq \epsilon.$$

This contradicts the fact that

$$\mathbb{P}_{p_k}(\mathcal{C}_H([0, N] \times [0, N])) \rightarrow 1/2,$$

the function $p \mapsto \mathbb{P}_p(\mathcal{C}_H([0, N] \times [0, N]))$ being continuous (it is polynomial in p). \square

3.2 Russo-Seymour-Welsh type estimates

When studying near-critical percolation, we will have to consider product measures $\hat{\mathbb{P}}$ more general than simply the measures \mathbb{P}_p ($p \in [0, 1]$), with associated parameters \hat{p}_v which are allowed to depend on the site v :

Definition 5. *A measure $\hat{\mathbb{P}}$ on configurations is said to be “between \mathbb{P}_p and \mathbb{P}_{1-p} ” if it is a product measure, and if its parameters \hat{p}_v are all between p and $1 - p$.*

The Russo-Seymour-Welsh theory implies that for each $k \geq 1$, there exists some $\delta_k = \delta_k(\epsilon) > 0$ (depending only on ϵ) such that for all p , $\hat{\mathbb{P}}$ between \mathbb{P}_p and \mathbb{P}_{1-p} ,

$$\forall n \leq L_\epsilon(p), \quad \hat{\mathbb{P}}(\mathcal{C}_H([0, kn] \times [0, n])) \geq \delta_k, \quad (3.4)$$

and for symmetry reasons this bound is also valid for horizontal white crossings.

These estimates for crossing probabilities will be the basic building blocks on which most further considerations are built. They imply that when n is not larger than $L_\epsilon(p)$, things can still be compared to critical percolation: roughly speaking, $L_\epsilon(p)$ is the scale up to which percolation can be considered as “almost critical”.

In the other direction, we will see in Section 7.4 that $L_\epsilon(p)$ is also the scale at which percolation starts to look sub- or super-critical. Assume for instance that $p > 1/2$, we know that

$$\mathbb{P}_p(\mathcal{C}_H([0, L_\epsilon(p)] \times [0, L_\epsilon(p)])) \geq 1 - \epsilon.$$

Then using RSW (Theorem 2), we get that

$$\mathbb{P}_p(\mathcal{C}_H([0, 2L_\epsilon(p)] \times [0, L_\epsilon(p)])) \geq 1 - \tilde{\epsilon},$$

where $1 - \tilde{\epsilon} = f_2(1 - \epsilon)$ can be made arbitrarily close to 1 by taking ϵ sufficiently small. This will be useful in the proof of Lemma 39 (but actually only for it).

3.3 Outline of the paper

In the following, we fix some value of ϵ in $(0, 1/2)$. For notational convenience, we forget about the dependence on ϵ . We will see later (Corollary 37) that the particular choice of ϵ is actually not relevant, in the sense that for any two ϵ, ϵ' , the corresponding lengths are of the same order of magnitude.

In Section 4 we define the so-called arm events. On a scale $L(p)$, the RSW property, which we know remains true, allows to derive separation results for these arms. Section 5 is devoted to critical percolation, in particular how arm exponents – describing the asymptotic behavior of arm events – can be computed. In Section 6 we study how arm events are affected when we make vary the parameter p : if we stay on a scale $L(p)$, the picture does not change too much. It can be used to describe the characteristic functions, which we do in Section 7. Finally, Section 8 concludes the paper with some remarks and possible applications.

With the exception of this last section, the organization follows the implication between the different results: each section depends on the previous ones. A limited number of results can however be obtained directly, we will indicate it clearly when this is the case.

4 Arm separation

We will see that when studying critical and near-critical percolation, certain exceptional events play a central role: the arm events, referring to the existence of some number of crossings (“arms”) of the annuli $S_{n,N}$ ($n < N$), the color of each crossing (black or white) being prescribed. These events are useful because they can be combined together, and they will prove to be instrumental for studying more complex events. Their asymptotic behavior can be described precisely using SLE_6 (see next section), allowing to derive further estimates, especially on the characteristic functions.

4.1 Arm events

Let us consider an integer $j \geq 1$. A color sequence σ is a sequence $(\sigma_1, \dots, \sigma_j)$ of “black” and “white” of length j . We use the letters “W” and “B” to encode the colors: the sequence (black, white, black) is thus denoted by “BWB”. Only the cyclic order of the arms is relevant, and we identify two sequences if they are the same up to a cyclic permutation: for instance, the two sequences “BWBW” and “WBWB” are the same, but they are different from “BBWW”. The resulting set is denoted by $\tilde{\mathcal{C}}_j$. For any color sequence σ , we also introduce $\tilde{\sigma} = (\tilde{\sigma}_1, \dots, \tilde{\sigma}_j)$ the inverted sequence, where each color is replaced by its opposite.

For any two positive integers $n \leq N$, we define the event

$$A_{j,\sigma}(n, N) := \{\partial S_n \rightsquigarrow_{j,\sigma} \partial S_N\} \quad (4.1)$$

that there exist j disjoint monochromatic arms in the annulus $S_{n,N}$, whose colors are those prescribed by σ , when taken in counterclockwise order (see Figure 5). We denote such an ordered set of crossings by $\mathcal{C} = \{c_i\}_{1 \leq i \leq j}$, and we say it to be “ σ -colored”. Recall that by convention, we have relaxed the color prescription for the extremities of the c_i ’s. Hence for $j = 1$ and $\sigma = B$, $A_{j,\sigma}(0, N)$ just denotes the existence of a black path $0 \rightsquigarrow \partial S_N$.

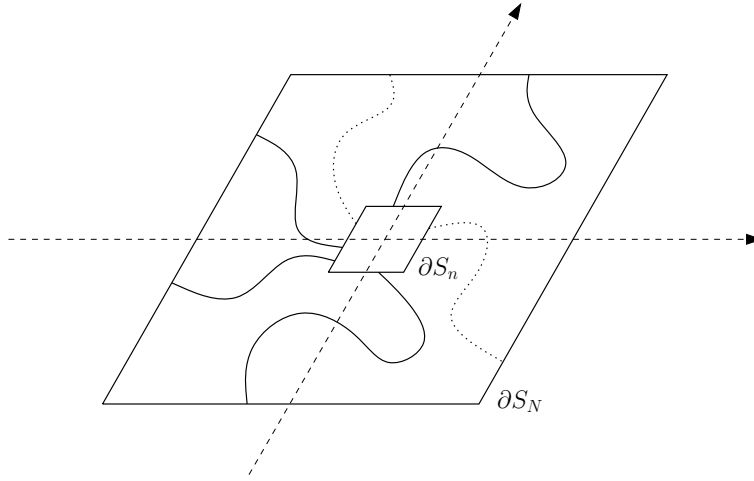

Figure 5: The event $A_{6,\sigma}(n, N)$, with $\sigma = BBBWBW$.

Note that a combinatorial objection due to discreteness can arise: if j is too large compared to n , the event $A_{j,\sigma}(n, N)$ can be void, just because the arms do not have enough space on ∂S_n to arrive all together. For instance $A_{j,\sigma}(0, N) = \emptyset$ if $j \geq 7$. In fact, we just have to check that n is large enough so that the number of sites touching the exterior of $|\partial S_n|$ (ie $|\partial S_{n+1}|$ with the acute corners removed) is at least j : if this is true, we can then draw straight lines heading toward the exterior. For each positive integer j , we thus introduce $n_0(j)$ the least such nonnegative integer, and we have

$$\forall N \geq n_0(j), \quad A_{j,\sigma}(n_0(j), N) \neq \emptyset.$$

Note that $n_0(j) = 0$ for $j = 1, \dots, 6$, and that $n_0(j) \leq j$. For asymptotics, the exact choice of n is not relevant since anyway, for any fixed $n_1, n_2 \geq n_0(j)$,

$$\hat{\mathbb{P}}(A_{j,\sigma}(n_1, N)) \asymp \hat{\mathbb{P}}(A_{j,\sigma}(n_2, N)).$$

Remark 6. Note that Reimer's inequality implies that for any two integers j, j' , and two color sequences σ, σ' of these lengths, we have:

$$\hat{\mathbb{P}}(A_{j+j',\sigma\sigma'}(n, N)) \leq \hat{\mathbb{P}}(A_{j,\sigma}(n, N))\hat{\mathbb{P}}(A_{j',\sigma'}(n, N)) \quad (4.2)$$

for any $\hat{\mathbb{P}}, n \leq N$ (denoting by $\sigma\sigma'$ the concatenation of σ and σ').

4.2 Well-separateness

We now impose some restrictions on the events $A_{j,\sigma}(n, N)$. Our main goal is to prove that we can separate macroscopically (the extremities of) any sequence of arms: with this additional condition, the probability of $A_{j,\sigma}(n, N)$ does not decrease from more than a (universal) constant factor. This result is not really surprising, but we will need it recurrently for technical purposes.

Let us now give a precise meaning to the property of being “separated” for sets of crossings. In the following, we will actually consider crossings in different domain shapes. We first state the definition for a parallelogram of fixed $(1 \times \tau)$ aspect ratio, and explain how to adapt it in other cases.

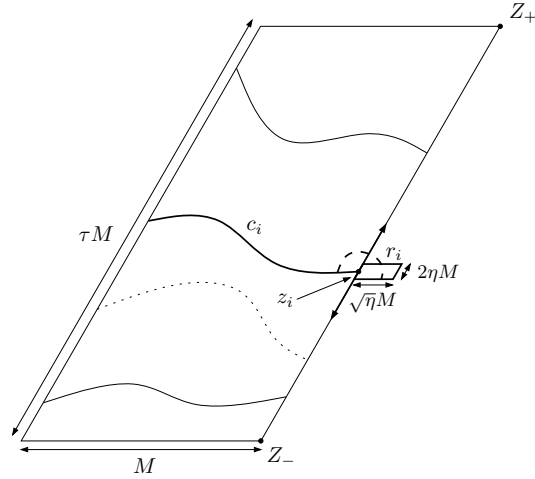

Figure 6: Well-separateness for a set of crossings $\mathcal{C} = \{c_i\}$.

We first require that the extremities of these crossings are distant from each other. We also need to add a condition ensuring that the crossings can easily be extended: we impose the existence of “free spaces” at their extremities, which will allow then to construct longer extensions. This leads to the following definition, similar to Kesten’s “fences” [31] (see Figure 6).

Definition 7. Consider some $M \times \tau M$ parallelogram $R = [a_1, a_1 + M] \times [b_1, b_1 + \tau M]$, and $\mathcal{C} = \{c_i\}_{1 \leq i \leq j}$ a (σ -colored) set of j disjoint left-right crossings. Introduce z_i the extremity of c_i on the right side of the parallelogram, and for some $\eta \in (0, 1]$, the parallelogram $r_i = z_i + [0, \sqrt{\eta}M] \times [-\eta M, \eta M]$, attached to R on its right side.

We say that \mathcal{C} is well-separated at scale η (on the right side) if the two following conditions are satisfied:

1. The extremity z_i of each crossing is not too close from the other ones:

$$\forall i \neq j, \quad \text{dist}(z_i, z_j) \geq 2\sqrt{\eta}M, \quad (4.3)$$

nor from the top and bottom right corners Z_+, Z_- of R :

$$\forall i, \quad \text{dist}(z_i, Z_{\pm}) \geq 2\sqrt{\eta}M. \quad (4.4)$$

2. Each r_i is crossed vertically by some crossing \tilde{c}_i of the same color as c_i , and

$$c_i \rightsquigarrow \tilde{c}_i \quad \text{in } \mathring{S}_{\sqrt{\eta}M}(z_i). \quad (4.5)$$

For the second condition, we of course require the path connecting c_i and \tilde{c}_i to be of the same color as these two crossings. The crossing \tilde{c}_i is thus some small extension of c_i on the right side of R . The free spaces r_i will allow us to use locally an FKG-type inequality to further extend the c_i 's on the right.

Definition 8. We say that a set $\mathcal{C} = \{c_i\}_{1 \leq i \leq j}$ of j disjoint left-right crossings of R can be made well-separated on the right side if there exists another set $\mathcal{C}' = \{c'_i\}_{1 \leq i \leq j}$ of j disjoint crossings that is well-separated on the right side, such that c'_i has the same color as c_i , and the same extremity on the left side.

The same definitions apply for well-separateness on the left side, and also for top-bottom crossings. Consider now a set of crossings of an annulus $S_{n,N}$. We can divide this set into four subsets, according to the side of ∂S_N on which they arrive. Take for instance the set of crossings arriving on the right side: we say it to be *well-separated* if, as before, the extremities of these crossings on ∂S_N are distant from each other and from the top-right and bottom-right corners, and if there exist free spaces r_i that satisfy condition 2 of Definition 7. Then, we say that a set of crossings of $S_{n,N}$ is well-separated on the external boundary if each of the four previous sets is itself well-separated. Note that requiring the extremities to be not too close from the corners ensures that they are not too close from the extremities of the crossings arriving on the other sides either. We take the same definition for the internal boundary ∂S_n : in this case, taking the extremities away from the corners also ensures that the free spaces are included in S_n and do not intersect each other.

We are in a position to define our first sub-event of $A_{j,\sigma}(n,N)$: for any $\eta, \eta' \in (0, 1)$,

$$\tilde{A}_{j,\sigma}^{\eta/\eta'}(n,N) := \{\partial S_n \rightsquigarrow_{j,\sigma}^{\eta/\eta'} \partial S_N\} \quad (4.6)$$

denotes the event $A_{j,\sigma}(n,N)$ with the additional condition that the set of j arms is well-separated at scale η on ∂S_n , and at scale η' on ∂S_N .

We can even prescribe the “landing areas” of the different arms, *ie* the position of their extremities. We introduce for that some last definition:

Definition 9. Consider ∂S_N for some integer N : a landing sequence $\{I_i\}_{1 \leq i \leq j}$ on ∂S_N is a sequence of disjoint sub-intervals I_1, \dots, I_j on ∂S_N in counterclockwise order. It is said to be η -separated if¹,

1. $\text{dist}(I_i, I_{i+1}) \geq 2\sqrt{\eta}N$ for each i ,
2. $\text{dist}(I_i, Z) \geq 2\sqrt{\eta}N$ for each i and each corner Z of ∂S_N .

It is called a landing sequence of size η if the additional property

3. $\text{length}(I_i) \geq \eta N$ for each i

is also satisfied.

We identify two landing sequences on ∂S_N and $\partial S_{N'}$ if they are identical up to a dilation. This leads to the following sub-event of $\tilde{A}_{j,\sigma}^{\eta/\eta'}(n,N)$: for two landing sequences $I = \{I_i\}_{1 \leq i \leq j}$ and $I' = \{I'_i\}_{1 \leq i' \leq j}$,

$$\tilde{\tilde{A}}_{j,\sigma}^{\eta, I/\eta', I'}(n,N) := \{\partial S_n \rightsquigarrow_{j,\sigma}^{\eta, I/\eta', I'} \partial S_N\} \quad (4.7)$$

denotes the event $\tilde{A}_{j,\sigma}^{\eta/\eta'}(n,N)$, with the additional requirement on the set of crossings $\{c_i\}_{1 \leq i \leq j}$ that for each i , the extremities z_i and z'_i of c_i on (respectively) ∂S_n and ∂S_N satisfy $z_i \in I_i$ and $z'_i \in I'_i$.

¹As usual, we consider cyclic indices, so that here for instance $I_{j+1} = I_1$.

We will also have use for another intermediate event between A and \tilde{A} : $\tilde{A}_{j,\sigma}^{I/I'}(n,N)$, for which we only impose the landing areas I/I' of the j arms. We do not ask *a priori* the sub-intervals to be η -separated either, just to be disjoint. Note however that if they are η/η' -separated, then the extremities of the different crossings will be η/η' -separated too.

To summarize:

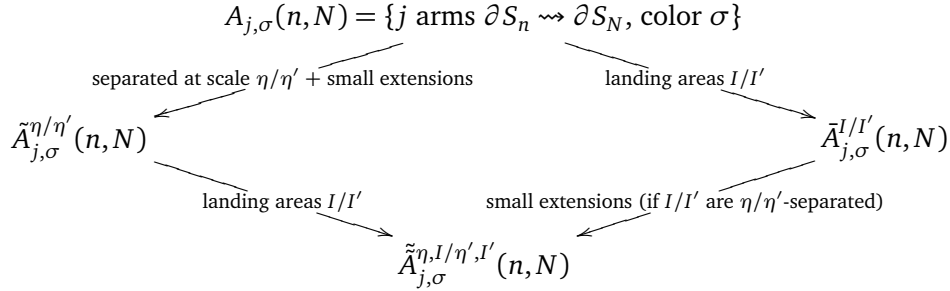

Remark 10. If we take for instance alternating colors ($\bar{\sigma} = BWBW$), and as landing areas $\bar{I}_1, \dots, \bar{I}_4$ the (resp.) right, top, left and bottom sides of ∂S_N , the 4-arm event $\tilde{A}_{4,\bar{\sigma}}^{\bar{I}}(0,N)$ (the “.” meaning that we do not put any condition on the internal boundary) is then the event that 0 is pivotal for the existence of a left-right crossing of S_N .

4.3 Statement of the results

Main result

Our main separation result is the following:

Theorem 11. Fix an integer $j \geq 1$, some color sequence $\sigma \in \tilde{\mathfrak{S}}_j$ and $\eta_0, \eta'_0 \in (0, 1)$. Then we have

$$\hat{\mathbb{P}}(\tilde{A}_{j,\sigma}^{\eta, I/\eta', I'}(n,N)) \asymp \hat{\mathbb{P}}(A_{j,\sigma}(n,N)) \quad (4.8)$$

uniformly in all landing sequences I/I' of size η/η' , with $\eta \geq \eta_0$ and $\eta' \geq \eta'_0$, $\hat{\mathbb{P}}$ between \mathbb{P}_p and \mathbb{P}_{1-p} , $n \leq N \leq L(p)$.

First relations

Before turning to the proof of this theorem, we list some direct consequences of the RSW estimates that will be needed.

Proposition 12. Fix $j \geq 1$, $\sigma \in \tilde{\mathfrak{S}}_j$ and $\eta_0, \eta'_0 \in (0, 1)$.

1. “Extendability”: We have

$$\hat{\mathbb{P}}(\tilde{A}_{j,\sigma}^{\eta, I/\tilde{\eta}', \tilde{I}'}(n, 2N)), \hat{\mathbb{P}}(\tilde{A}_{j,\sigma}^{\tilde{\eta}, \tilde{I}/\eta', I'}(n/2, N)) \asymp \hat{\mathbb{P}}(\tilde{A}_{j,\sigma}^{\eta, I/\eta', I'}(n, N))$$

uniformly in p , $\hat{\mathbb{P}}$ between \mathbb{P}_p and \mathbb{P}_{1-p} , $n \leq N \leq L(p)$, and all landing sequences I/I' (resp. \tilde{I}/\tilde{I}') of size η/η' (resp. $\tilde{\eta}/\tilde{\eta}'$) larger than η_0/η'_0 . In other words: “once well-separated, the arms can easily be extended”.

2. “Quasi-multiplicativity”: We have for some $C = C(\eta_0, \eta'_0) > 0$

$$\hat{\mathbb{P}}(A_{j,\sigma}(n_1, n_3)) \geq C \hat{\mathbb{P}}(\tilde{A}_{j,\sigma}^{\eta, I}(n_1, n_2/4)) \hat{\mathbb{P}}(\tilde{A}_{j,\sigma}^{\eta', I'}(n_2, n_3))$$

uniformly in p , $\hat{\mathbb{P}}$ between \mathbb{P}_p and \mathbb{P}_{1-p} , $n_0(j) \leq n_1 < n_2 < n_3 \leq L(p)$ with $n_2 \geq 4n_1$, and all landing sequences I/I' of size η/η' larger than η_0/η'_0 .

3. For any $\eta, \eta' > 0$, there exists a constant $C = C(\eta, \eta') > 0$ with the following property: for any p , $\hat{\mathbb{P}}$ between \mathbb{P}_p and \mathbb{P}_{1-p} , $n \leq N \leq L(p)$, there exist two landing sequences I and I' of size η and η' (that may depend on all the parameters mentioned) such that

$$\hat{\mathbb{P}}(\tilde{A}_{j,\sigma}^{\eta, I/\eta', I'}(n, N)) \geq C \hat{\mathbb{P}}(\tilde{A}_{j,\sigma}^{\eta, \eta'}(n, N)).$$

Proof. The proof relies on gluing arguments based on RSW constructions. However, the events considered are not monotone when σ is non-constant (there is at least one black arm and one white arm). We will thus need a slight generalization of the FKG inequality for events “locally monotone”.

Lemma 13. Consider A^+ , \tilde{A}^+ two increasing events, and A^- , \tilde{A}^- two decreasing events. Assume that there exist three disjoint finite sets of vertices \mathcal{A} , \mathcal{A}^+ and \mathcal{A}^- such that A^+ , A^- , \tilde{A}^+ and \tilde{A}^- depend only on the sites in, respectively, $\mathcal{A} \cup \mathcal{A}^+$, $\mathcal{A} \cup \mathcal{A}^-$, \mathcal{A}^+ and \mathcal{A}^- . Then we have

$$\hat{\mathbb{P}}(\tilde{A}^+ \cap \tilde{A}^- | A^+ \cap A^-) \geq \hat{\mathbb{P}}(\tilde{A}^+) \hat{\mathbb{P}}(\tilde{A}^-) \quad (4.9)$$

for any product measure $\hat{\mathbb{P}}$.

Proof. Conditionally on the configuration $\omega_{\mathcal{A}}$ in \mathcal{A} , the events $A^+ \cap \tilde{A}^+$ and $A^- \cap \tilde{A}^-$ are independent, so that

$$\hat{\mathbb{P}}(A^+ \cap \tilde{A}^+ \cap A^- \cap \tilde{A}^- | \omega_{\mathcal{A}}) = \hat{\mathbb{P}}(A^+ \cap \tilde{A}^+ | \omega_{\mathcal{A}}) \hat{\mathbb{P}}(A^- \cap \tilde{A}^- | \omega_{\mathcal{A}}).$$

The FKG inequality implies that

$$\begin{aligned} \hat{\mathbb{P}}(A^+ \cap \tilde{A}^+ | \omega_{\mathcal{A}}) &\geq \hat{\mathbb{P}}(A^+ | \omega_{\mathcal{A}}) \hat{\mathbb{P}}(\tilde{A}^+ | \omega_{\mathcal{A}}) \\ &= \hat{\mathbb{P}}(A^+ | \omega_{\mathcal{A}}) \hat{\mathbb{P}}(\tilde{A}^+) \end{aligned}$$

and similarly with A^- and \tilde{A}^- . Hence,

$$\begin{aligned} \hat{\mathbb{P}}(A^+ \cap \tilde{A}^+ \cap A^- \cap \tilde{A}^- | \omega_{\mathcal{A}}) &\geq \hat{\mathbb{P}}(A^+ | \omega_{\mathcal{A}}) \hat{\mathbb{P}}(\tilde{A}^+) \hat{\mathbb{P}}(A^- | \omega_{\mathcal{A}}) \hat{\mathbb{P}}(\tilde{A}^-) \\ &= \hat{\mathbb{P}}(A^+ \cap A^- | \omega_{\mathcal{A}}) \hat{\mathbb{P}}(\tilde{A}^+) \hat{\mathbb{P}}(\tilde{A}^-). \end{aligned}$$

The conclusion follows by summing over all configurations $\omega_{\mathcal{A}}$. □

Once this lemma is at our disposal, items 1. and 2. are straightforward. For item 3., we consider a covering of ∂S_n (resp. ∂S_N) with at most $8\eta^{-1}$ (resp. $8\eta'^{-1}$) intervals $\{I\}$ of length η (resp. I' of length η'). Then for some I, I' ,

$$\hat{\mathbb{P}}(\tilde{A}_{j,\sigma}^{\eta, I/\eta', I'}(n, N)) \geq (8\eta^{-1})^{-1} (8\eta'^{-1})^{-1} \hat{\mathbb{P}}(\tilde{A}_{j,\sigma}^{\eta, \eta'}(n, N)).$$

□

We also have the following a-priori bounds for the arm events:

Proposition 14. Fix some $j \geq 1$, $\sigma \in \tilde{\mathfrak{S}}_j$ and $\eta_0, \eta'_0 \in (0, 1)$. Then there exist some exponents $0 < \alpha_j, \alpha' < \infty$, as well as constants $0 < C_j, C' < \infty$, such that

$$C_j \left(\frac{n}{N} \right)^{\alpha_j} \leq \hat{\mathbb{P}}(\tilde{A}_{j,\sigma}^{\eta, I/\eta', I'}(n, N)) \leq C' \left(\frac{n}{N} \right)^{\alpha'} \quad (4.10)$$

uniformly in p , $\hat{\mathbb{P}}$ between \mathbb{P}_p and \mathbb{P}_{1-p} , $n \leq N \leq L(p)$, and all landing sequences I/I' of size η/η' larger than η_0/η'_0 .

The lower bound comes from iterating item 1. The upper bound can be obtained by using concentric annuli: in each of them, RSW implies that there is a probability bounded away from zero to observe a black circuit, preventing the existence of a white arm (consider a white circuit instead if $\sigma = BB \dots B$).

4.4 Proof of the main result

Assume that $A_{j,\sigma}(n, N)$ is satisfied: our goal is to link this event to the event $\tilde{A}_{j,\sigma}^{\eta_0, I_{\eta_0}/\eta'_0, I_{\eta'_0}}(n, N)$, for some fixed scales η_0, η'_0 .

Proof. First note that it suffices to prove the result for n, N which are powers of two: then we would have, if k, K are such that $2^{k-1} < n \leq 2^k$ and $2^K \leq N < 2^{K+1}$,

$$\begin{aligned} \hat{\mathbb{P}}(A_{j,\sigma}(n, N)) &\leq \hat{\mathbb{P}}(A_{j,\sigma}(2^k, 2^K)) \\ &\leq C_1 \hat{\mathbb{P}}(\tilde{A}_{j,\sigma}^{\eta, I/\eta', I'}(2^k, 2^K)) \\ &\leq C_2 \hat{\mathbb{P}}(\tilde{A}_{j,\sigma}^{\eta, I/\eta', I'}(n, N)). \end{aligned}$$

We have to deal with the extremities of the j arms on the internal boundary ∂S_n , and on the external boundary ∂S_N .

1. External extremities

Let us begin with the external boundary. In the course of proof, we will have use for the intermediate event $\tilde{A}_{j,\sigma}^{\eta'}(n, N)$ that there exists a set of j arms that is well-separated on the external side ∂S_N only, and also the event $\tilde{A}_{j,\sigma}^{\eta, I/\eta', I'}(n, N)$ associated to some landing sequence I' on ∂S_N . Each of the j arms induces in $S_{2^{k-1}, 2^k}$ a crossing of one of the four U-shaped regions $U_{2^{k-1}}^{1,\text{ext}}, \dots, U_{2^{k-1}}^{4,\text{ext}}$ depicted in Figure 7. The “ext” indicates that a crossing of such a region connects the two marked parts of the boundary. For the internal extremities, we will use the same regions, but we distinguish different parts of the boundary. The key observation is the following.

In a U-shaped region, any set of disjoint crossings can be made well-separated with high probability.

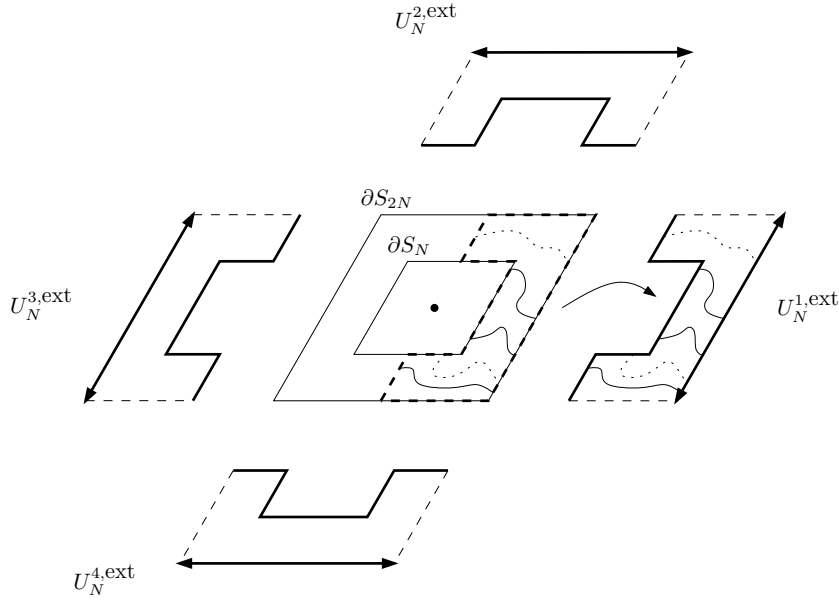

Figure 7: The four U-shaped regions that we use for the external extremities.

More precisely, if we take such an $N \times 4N$ domain, the probability that any set of disjoint crossings can be made η -well-separated (on the external boundary) can be made arbitrarily close to 1 by choosing η sufficiently small, uniformly in N . We prove the following lemma, which implies that on every scale, with very high probability the j arms can be made well-separated.

Lemma 15. *For any $\delta > 0$, there exists a size $\eta(\delta) > 0$ such that for any p , any $\hat{\mathbb{P}}$ between \mathbb{P}_p and \mathbb{P}_{1-p} and any $N \leq L(p)$: in the domain $U_N^{1,ext}$,*

$$\hat{\mathbb{P}}(\text{Any set of disjoint crossings can be made } \eta\text{-well-separated}) \geq 1 - \delta. \quad (4.11)$$

Proof. First we note that there cannot be too many disjoint crossings in $U_N^{1,ext}$. Indeed, there is a crossing in this domain (either white or black) with probability less than some $1 - \delta'$, by RSW: combined with the BK inequality (and also FKG), this implies that the probability of observing at least T crossings is less than

$$(1 - \delta')^T. \quad (4.12)$$

We thus take T such that this quantity is less than $\delta/4$.

Consider for the moment any $\eta \in (0, 1)$ (we will see during the proof how to choose it). We note that we can put disjoint annuli around Z_- and Z_+ to prevent crossings from arriving there. Consider Z_- for instance, and look at the disjoint annuli centered on Z_- of the form $S_{2^{l-1}, 2^l}(Z_-)$, with $\sqrt{\eta}N \leq 2^{l-1} < 2^l \leq \eta^{3/8}N$ (see Figure 8). We can take at least $-C_4 \log \eta$ such disjoint annuli for some universal constant $C_4 > 0$, and with probability at least $1 - (1 - \delta'')^{-C_4 \log \eta}$ there exists a black circuit in one of the annuli. Consider then the annuli $S_{2^{l-1}, 2^l}(Z_-)$, with $\eta^{3/8}N \leq 2^{l-1} < 2^l \leq \eta^{1/4}N$: with probability at least $1 - (1 - \delta'')^{-C_4 \log \eta}$ we observe a white circuit in one of them. If two circuits as described exist, we say that Z_- is “protected”. The same reasoning applies for Z_+ .

Consider now the following construction: take c_1 the lowest (ie closest to the bottom side) monochromatic crossing (which can be either black or white), then c_2 the lowest monochromatic crossing disjoint from c_1 , and so on. The process stops after t steps, and we denote by $\mathcal{C} = \{c_u\}_{1 \leq u \leq t}$ the set of crossings so-obtained. Of course, \mathcal{C} can be void: we set $t = 0$ in this case. We have

$$\mathbb{P}(t \geq T) \leq (1 - \delta')^T \leq \delta/4 \quad (4.13)$$

by definition of T . We denote by z_u the extremity of c_u on the right side, and by $\sigma_u \in \{B, W\}$ its color.

In order to get some independence and be able to apply the previous construction around the extremities of the crossings, we condition on the successive crossings. Consider some $u \in \{1, \dots, T\}$ and some ordered sequence of crossings $\tilde{c}_1, \tilde{c}_2, \dots, \tilde{c}_u$, together with colors $\tilde{\sigma}_1, \tilde{\sigma}_2, \dots, \tilde{\sigma}_u$. The event $E_u := \{t \geq u \text{ and } c_v = \tilde{c}_v, \sigma_v = \tilde{\sigma}_v \text{ for any } v \in \{1, \dots, u\}\}$ is independent from the status of the sites above \tilde{c}_u . Hence, if we condition on E_u , percolation there remains unbiased and we can use the RSW theorem.

We now do the same construction as before. Look at the disjoint annuli centered on z_u of the form $S_{2^{l-1}, 2^l}(z_u)$, with $\sqrt{\eta}N \leq 2^{l-1} < 2^l \leq \eta^{3/8}N$ on one hand, and with $\eta^{3/4}N \leq 2^{l-1} < 2^l \leq \eta^{1/4}N$ on the other hand. Assume for instance that $\tilde{\sigma}_u = B$. With probability at least $1 - (1 - \delta'')^{-C_4'' \log \eta}$ we observe a white circuit in one of the annuli in the first set, preventing other disjoint black crossings to arrive near z_u , and also a black one in the second set, preventing white crossings to arrive. Moreover, by considering a black circuit in the annuli $S_{2^{l-1}, 2^l}(z_u)$ with $\eta^{3/4}N \leq 2^{l-1} < 2^l \leq \sqrt{\eta}N$, we can construct a small extension of c_u . If the three circuits described exist, c_u is said to be “protected from above”. Summing over all possibilities for $\tilde{c}_i, \tilde{\sigma}_i$ ($1 \leq i \leq u$), we get that for some C_4''' ,

$$\mathbb{P}(t \geq u \text{ and } c_u \text{ is not protected from above}) \leq (1 - \delta'')^{-C_4''' \log \eta}. \quad (4.14)$$

Now for our set of crossings \mathcal{C} ,

$$\begin{aligned} & \mathbb{P}(\mathcal{C} \text{ is not } \eta\text{-well-separated}) \\ & \leq \mathbb{P}(t \geq T) + \sum_{u=1}^{T-1} \mathbb{P}(t \geq u \text{ and } c_u \text{ is not protected from above}) \\ & \quad + \mathbb{P}(Z_- \text{ is not protected}) + \mathbb{P}(Z_+ \text{ is not protected}). \end{aligned}$$

First, each term in the sum, as well as the last two terms, are less than $(1 - \delta'')^{-C_4''' \log \eta}$. We also have $\mathbb{P}(t \geq T) \leq \delta/4$, so that the right-hand side is at most

$$(T + 1)(1 - \delta'')^{-C_4''' \log \eta} + \frac{\delta}{4}. \quad (4.15)$$

It is less than δ if we choose η sufficiently small (T is fixed).

We now assume that \mathcal{C} is η -well-separated, and prove that any other set $\mathcal{C}' = \{c'_u\}_{1 \leq u \leq t'}$ of t' ($\leq t$) disjoint crossings (we take it ordered) can also be made η -well-separated. For that purpose, we replace recursively the tip of each c'_u by the tip of one of the c_v 's. If we take c'_1 for instance, it has to cross at least one of the c_v 's (by maximality of \mathcal{C}). Let us call c_{v_1} the lowest one: still by maximality, c'_1 cannot go below it. Take the piece of c'_1 between its extremity z'_1 and its last intersection a_1 with c_{v_1} , and replace it with the corresponding piece of c_{v_1} : this gives c''_1 . This new crossing has the

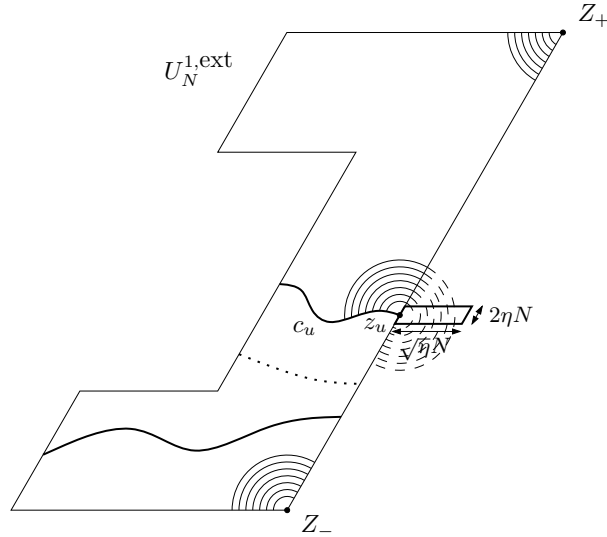

Figure 8: We apply RSW in concentric annuli around Z_- and Z_+ , and then around the extremity z_u of each crossing c_u .

same extremity as c_{v_1} on the right side, and it is not hard to check that it is connected to the small extension \tilde{c}_{v_1} of c_{v_1} on the external side. Indeed, this extension is connected by a path that touches c_{v_1} in, say, b_1 : either b_1 is between a_1 and z_1 , in which case c_1'' is automatically connected to \tilde{c}_{v_1} , otherwise c_1' has to cross the connecting path before a_1 and c_1'' is also connected to \tilde{c}_{v_1} .

Consider then c_2 , and c_{v_2} the lowest crossing it intersects: necessarily $v_2 > v_1$ (since c_1 stays above c_{v_1}), and the same reasoning applies. The claim follows by continuing this procedure until c_t' .

□

The arms are well-separated with positive probability.

The idea is then to “go down” in successive concentric annuli, and to apply the lemma in each of them. We work with two different scales of separation:

- a fixed (macroscopic) scale η'_0 that we will use to extend arms, associated to a *constant* extension cost.
- another scale η' which is *very* small ($\eta' \ll \eta'_0$), so that the j arms can be made well-separated at scale η' with very high probability.

The proof goes as follows. Take some $\delta > 0$ very small (we will see later how small), and some $\eta' > 0$ associated to it by Lemma 15. We start from the scale ∂S_{2^k} and look at the crossings induced by the j arms. The previous lemma implies that with very high probability, these j arms can be modified in $S_{2^{k-1}, 2^k}$ so that they are η' -well-separated. Otherwise, we go down to the next annulus: there still exist j arms, and what happens in $S_{2^{k-1}, 2^k}$ is independent of what happens in $S_{2^{k-1}}$. On each scale, we have a very low probability to fail, and once the arms are separated on scale η' , we go backwards by using the scale η'_0 , for which the cost of extension is constant.

More precisely, after one step we get

$$A_{j,\sigma}(2^k, 2^K) \subseteq \tilde{A}_{j,\sigma}^{\cdot/\eta'}(2^k, 2^K) \cup \left(\{\text{One of the four } U_{2^{k-1}}^{i,\text{ext}} \text{ fails}\} \cap A_{j,\sigma}(2^k, 2^{K-1}) \right).$$

Hence, by independence of the two latter events and Lemma 15,

$$\hat{\mathbb{P}}(A_{j,\sigma}(2^k, 2^K)) \leq \hat{\mathbb{P}}(\tilde{A}_{j,\sigma}^{\cdot/\eta'}(2^k, 2^K)) + (4\delta)\hat{\mathbb{P}}(A_{j,\sigma}(2^k, 2^{K-1})).$$

We then iterate this argument: after $K - k$ steps,

$$\begin{aligned} \hat{\mathbb{P}}(A_{j,\sigma}(2^k, 2^K)) &\leq \hat{\mathbb{P}}(\tilde{A}_{j,\sigma}^{\cdot/\eta'}(2^k, 2^K)) + (4\delta)\hat{\mathbb{P}}(\tilde{A}_{j,\sigma}^{\cdot/\eta'}(2^k, 2^{K-1})) + (4\delta)^2\hat{\mathbb{P}}(\tilde{A}_{j,\sigma}^{\cdot/\eta'}(2^k, 2^{K-2})) + \dots \\ &\quad + (4\delta)^{K-k-1}\hat{\mathbb{P}}(\tilde{A}_{j,\sigma}^{\cdot/\eta'}(2^k, 2^{k+1})) + (4\delta)^{K-k}. \end{aligned}$$

We then use the size η'_0 to go backwards: if the crossings are η' -separated at some scale m , there exists some landing sequence $I_{\eta'}$ of size η' where the probability of landing is comparable to the probability of just being η' -well-separated, and then we can reach $I_{\eta'_0}$ of size η'_0 on the next scale. More precisely, there exist universal constants $C_1(\eta')$, $C_2(\eta')$ depending only on η' such that for all $1 \leq i' \leq i$, we can choose some $I_{\eta'}$ (which can depend on i') such that

$$\hat{\mathbb{P}}(\tilde{A}_{j,\sigma}^{\cdot/\eta'}(2^k, 2^{K-i'})) \leq C_1(\eta')\hat{\mathbb{P}}(\tilde{A}_{j,\sigma}^{\cdot/\eta', I_{\eta'}}(2^k, 2^{K-i'}))$$

(by item 3. of Proposition 12) and then go to $I_{\eta'_0}$ on the next scale with cost $C_2(\eta')$:

$$\hat{\mathbb{P}}(\tilde{A}_{j,\sigma}^{\cdot/\eta', I_{\eta'}}(2^k, 2^{K-i'})) \leq C_2(\eta')\hat{\mathbb{P}}(\tilde{A}_{j,\sigma}^{\cdot/\eta'_0, I_{\eta'_0}}(2^k, 2^{K-i'+1}))$$

(by item 1.). Now for the size η'_0 , going from ∂S_m to ∂S_{2m} has a cost C'_0 depending *only* on η'_0 on each scale m , we thus have

$$\hat{\mathbb{P}}(\tilde{A}_{j,\sigma}^{\cdot/\eta'}(2^k, 2^{K-i'})) \leq C_1(\eta')C_2(\eta')C_0^{i'-1}\hat{\mathbb{P}}(\tilde{A}_{j,\sigma}^{\cdot/\eta'_0, I_{\eta'_0}}(2^k, 2^K)).$$

There remains a problem with the first term $\hat{\mathbb{P}}(\tilde{A}_{j,\sigma}^{\cdot/\eta'}(2^k, 2^K))$. . . So assume that we have started from 2^{K-1} instead, so that the annulus $S_{2^{K-1}, 2^K}$ remains free:

$$\begin{aligned} \hat{\mathbb{P}}(A_{j,\sigma}(2^k, 2^K)) &\leq \hat{\mathbb{P}}(A_{j,\sigma}(2^k, 2^{K-1})) \\ &\leq \hat{\mathbb{P}}(\tilde{A}_{j,\sigma}^{\cdot/\eta'}(2^k, 2^{K-1})) + (4\delta)\hat{\mathbb{P}}(\tilde{A}_{j,\sigma}^{\cdot/\eta'}(2^k, 2^{K-2})) + (4\delta)^2\hat{\mathbb{P}}(\tilde{A}_{j,\sigma}^{\cdot/\eta'}(2^k, 2^{K-3})) + \dots \\ &\quad + (4\delta)^{K-k-2}\hat{\mathbb{P}}(\tilde{A}_{j,\sigma}^{\cdot/\eta'}(2^k, 2^{k+1})) + (4\delta)^{K-k-1} \\ &\leq C_1(\eta')C_2(\eta') \left[1 + (4\delta C_0) + \dots + (4\delta C_0)^{K-k-1} \right] \hat{\mathbb{P}}(\tilde{A}_{j,\sigma}^{\cdot/\eta'_0, I_{\eta'_0}}(2^k, 2^K)). \end{aligned}$$

Now C_0 is fixed as was noticed before, so we may have taken δ such that $4\delta C_0 < 1/2$, so that

$$C_1(\eta')C_2(\eta') \left[1 + (4\delta C_0) + \dots + (4\delta C_0)^{K-k-1} \right] \leq C_3(\eta')$$

for some $C_3(\eta')$. We have thus reached the desired conclusion for external extremities:

$$\hat{\mathbb{P}}(A_{j,\sigma}(2^k, 2^K)) \leq C_3(\eta')\hat{\mathbb{P}}(\tilde{A}_{j,\sigma}^{\cdot/\eta'_0, I_{\eta'_0}}(2^k, 2^K)).$$

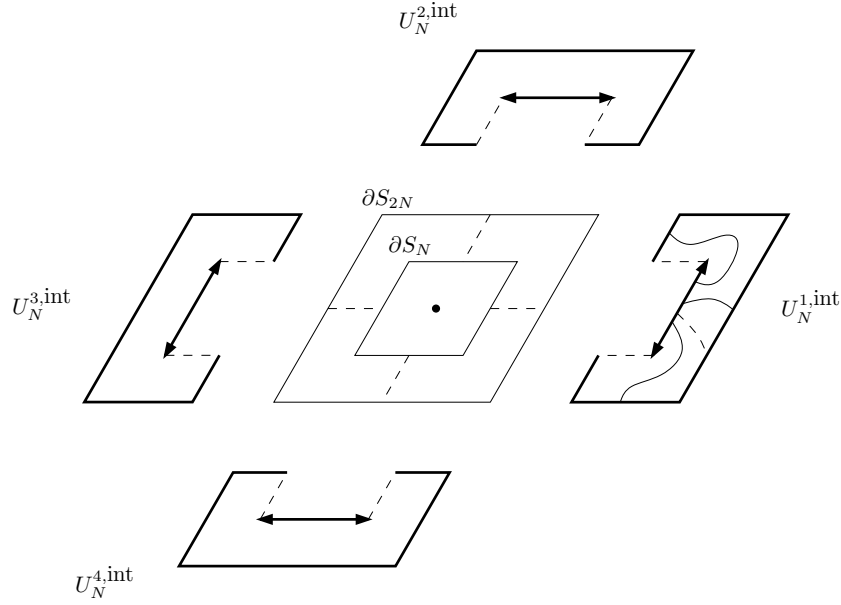

Figure 9: For the internal extremities, we consider the same domains but we mark different parts of the boundary.

2. Internal extremities

The reasoning is the same for internal extremities, except that we work in the other direction, from ∂S_{2^k} toward the interior. If we consider the domains $U_N^{i,int}$ having the same shapes as the $U_N^{i,ext}$ domains, but with different parts of the boundary distinguished (see Figure 9), then the lemma remains true. Hence,

$$\begin{aligned}
\hat{\mathbb{P}}(\tilde{A}_{j,\sigma}^{\tilde{\eta}_0, I_{\eta'_0}}(2^k, 2^K)) &\leq \hat{\mathbb{P}}(\tilde{A}_{j,\sigma}^{\tilde{\eta}_0, I_{\eta'_0}}(2^{k+1}, 2^K)) \\
&\leq \hat{\mathbb{P}}(\tilde{A}_{j,\sigma}^{\tilde{\eta}_0, I_{\eta'_0}}(2^{k+1}, 2^K)) + (4\delta)\hat{\mathbb{P}}(\tilde{A}_{j,\sigma}^{\tilde{\eta}_0, I_{\eta'_0}}(2^{k+2}, 2^K)) + \dots \\
&\quad + (4\delta)^{K-k-2}\hat{\mathbb{P}}(\tilde{A}_{j,\sigma}^{\tilde{\eta}_0, I_{\eta'_0}}(2^{K-1}, 2^K)) + (4\delta)^{K-k-1} \\
&\leq C_1(\eta)C_2(\eta) \left[1 + (4\delta C_0) + \dots + (4\delta C_0)^{K-k-1} \right] \hat{\mathbb{P}}(\tilde{A}_{j,\sigma}^{\tilde{\eta}_0, I_{\eta'_0}}(2^k, 2^K))
\end{aligned}$$

and the conclusion follows. \square

4.5 Some consequences

We now state some important consequences of the previous theorem.

Extendability

Proposition 16. Take $j \geq 1$ and a color sequence $\sigma \in \tilde{\mathfrak{S}}_j$. Then

$$\hat{\mathbb{P}}(A_{j,\sigma}(n, 2N)), \hat{\mathbb{P}}(A_{j,\sigma}(n/2, N)) \asymp \hat{\mathbb{P}}(A_{j,\sigma}(n, N)) \quad (4.16)$$

uniformly in p , $\hat{\mathbb{P}}$ between \mathbb{P}_p and \mathbb{P}_{1-p} and $n_0(j) \leq n \leq N \leq L(p)$.

Proof. This proposition comes directly from combining the arm separation theorem with the extendability property of the \tilde{A} events (item 1. of Proposition 12). \square

Quasi-multiplicativity

Proposition 17. Take $j \geq 1$ and a color sequence $\sigma \in \tilde{\mathfrak{S}}_j$. Then

$$\hat{\mathbb{P}}(A_{j,\sigma}(n_1, n_2))\hat{\mathbb{P}}(A_{j,\sigma}(n_2, n_3)) \asymp \hat{\mathbb{P}}(A_{j,\sigma}(n_1, n_3)) \quad (4.17)$$

uniformly in p , $\hat{\mathbb{P}}$ between \mathbb{P}_p and \mathbb{P}_{1-p} and $n_0(j) \leq n_1 < n_2 < n_3 \leq L(p)$.

Proof. On one hand, we have

$$\hat{\mathbb{P}}(A_{j,\sigma}(n_1, n_3)) \leq \hat{\mathbb{P}}(A_{j,\sigma}(n_1, n_2) \cap A_{j,\sigma}(n_2, n_3)) = \hat{\mathbb{P}}(A_{j,\sigma}(n_1, n_2))\hat{\mathbb{P}}(A_{j,\sigma}(n_2, n_3))$$

by independence of the events $A_{j,\sigma}(n_1, n_2)$ and $A_{j,\sigma}(n_2, n_3)$.

On the other hand, we may assume that $n_2 \geq 8n_1$. Then for some η_0, I_{η_0} , the previous results (separation and extendability) allow to use the quasi-multiplicativity for \tilde{A} events (item 2. of Proposition 12):

$$\begin{aligned} \hat{\mathbb{P}}(A_{j,\sigma}(n_1, n_2))\hat{\mathbb{P}}(A_{j,\sigma}(n_2, n_3)) &\asymp \hat{\mathbb{P}}(A_{j,\sigma}(n_1, n_2/4))\hat{\mathbb{P}}(A_{j,\sigma}(n_2, n_3)) \\ &\asymp \hat{\mathbb{P}}(\tilde{A}_{j,\sigma}^{\tilde{\cdot}/\eta_0, I_{\eta_0}}(n_1, n_2/4))\hat{\mathbb{P}}(\tilde{A}_{j,\sigma}^{\tilde{\cdot}\eta_0, I_{\eta_0}/\cdot}(n_2, n_3)) \\ &\asymp \hat{\mathbb{P}}(A_{j,\sigma}(n_1, n_3)). \end{aligned}$$

\square

Arms with defects

In some situations, the notion of arms that are completely monochromatic is too restrictive, and the following question arises quite naturally: do the probabilities change if we allow the arms to present some (fixed) number of “defects”, ie sites of the opposite color?

We define $A_{j,\sigma}^{(d)}(n, N)$ the event that there exist j disjoint arms a_1, \dots, a_j from ∂S_n to ∂S_N with the property: for any $i \in \{1, \dots, j\}$, a_i contains at most d sites of color $\tilde{\sigma}_i$. The quasi-multiplicativity property entails the following result, which will be needed for the proof of Theorem 27:

Proposition 18. Let $j \geq 1$ and $\sigma \in \tilde{\mathfrak{S}}_j$. Fix also some number d of defects. Then we have

$$\hat{\mathbb{P}}(A_{j,\sigma}^{(d)}(n, N)) \asymp (1 + \log(N/n))^d \hat{\mathbb{P}}(A_{j,\sigma}(n, N)) \quad (4.18)$$

uniformly in p , $\hat{\mathbb{P}}$ between \mathbb{P}_p and \mathbb{P}_{1-p} and $n_0(j) \leq n \leq N \leq L(p)$.

Actually, we will only need the upper bound on $\hat{\mathbb{P}}(A_{j,\sigma}^{(d)}(n, N))$. For instance, we will see in the next section that the arm events decay like power laws at the critical point. This proposition thus implies, in particular, that the “arm with defects” events are described by the same exponents: allowing defects just adds a logarithmic correction.

Proof. We introduce a logarithmic division of the annulus $S_{n,N}$: we take k and K such that $2^{k-1} < n \leq 2^k$ and $2^K \leq N < 2^{K+1}$. Roughly speaking, we “take away” the annuli where the defects take place, and “glue” the pieces of arms in the remaining annuli by using the quasi-multiplicativity property.

Let us begin with the upper bound: we proceed by induction on d . The property clearly holds for $d = 0$. Take some $d \geq 1$: by considering the first annuli $S_{2^i, 2^{i+1}}$ where a defect occurs, we get

$$\hat{\mathbb{P}}(A_{j,\sigma}^{(d)}(n, N)) \leq \sum_{i=k}^{K-1} \hat{\mathbb{P}}(A_{j,\sigma}(2^k, 2^i)) \hat{\mathbb{P}}(A_{j,\sigma}^{(d-1)}(2^{i+1}, 2^K)). \quad (4.19)$$

We have $\hat{\mathbb{P}}(A_{j,\sigma}^{(d-1)}(2^{i+1}, 2^K)) \leq C_{d-1}(1 + \log(N/n))^{d-1} \hat{\mathbb{P}}(A_{j,\sigma}(2^{i+1}, 2^K))$ thanks to the induction hypothesis, and by quasi-multiplicativity,

$$\begin{aligned} \hat{\mathbb{P}}(A_{j,\sigma}^{(d)}(n, N)) &\leq (1 + \log(N/n))^{d-1} C_{d-1} \sum_{i=k}^{K-1} \hat{\mathbb{P}}(A_{j,\sigma}(2^k, 2^i)) \hat{\mathbb{P}}(A_{j,\sigma}(2^{i+1}, 2^K)) \\ &\leq C_{d-1}(1 + \log(N/n))^{d-1} \sum_{i=k}^{K-1} C' \hat{\mathbb{P}}(A_{j,\sigma}(2^k, 2^K)) \\ &\leq C_d(1 + \log(N/n))^{d-1} (K - k) \hat{\mathbb{P}}(A_{j,\sigma}(2^k, 2^K)), \end{aligned}$$

which gives the desired upper bound.

For the lower bound, note that for any $k \leq i_0 < i_1 < \dots < i_d < i_{d+1} = K$, $A_{j,\sigma}^{(d)}(n, N) \supseteq A_{j,\sigma}^{(d)}(2^{k-1}, 2^{K+1}) \supseteq A_{j,\sigma}^{(d)}(2^{k-1}, 2^{K+1}) \cap \{\text{Each of the } j \text{ arms has exactly one defect in each of the annuli } S_{2^{i_r}, 2^{i_r+1}}, 1 \leq r \leq d\}$, so that for $K - k \geq d + 1$,

$$\begin{aligned} \hat{\mathbb{P}}(A_{j,\sigma}^{(d)}(n, N)) &\geq \sum_{k=i_0 < i_1 < i_2 < \dots < i_d < i_{d+1} = K} C_d \prod_{r=0}^d \hat{\mathbb{P}}(A_{j,\sigma}(2^{i_r+1}, 2^{i_r+1})) \\ &\geq C'_d \binom{K-k-1}{d} \hat{\mathbb{P}}(A_{j,\sigma}(2^{k-1}, 2^{K+1})) \\ &\geq C''_d (K-k)^d \hat{\mathbb{P}}(A_{j,\sigma}(2^{k-1}, 2^{K+1})), \end{aligned}$$

and our lower bound follows. \square

Remark: more general annuli

We will sometimes need to consider more general arm events, in annuli of the form $R \setminus r$, for non-necessarily concentric parallelograms $r \subseteq \hat{R}$. Items 1. and 2. of Proposition 12 can easily be extended. Separateness and well-separateness can be defined in the same way for these arm events,

and for any $\tau > 1$, we can get results uniform in the usual parameters and in parallelograms r, R such that $S_n \subseteq r \subseteq S_{\tau n}$ and $S_{N/\tau} \subseteq R \subseteq S_N$ for some $n, N \leq L(p)$:

$$\hat{\mathbb{P}}(\partial r \rightsquigarrow_{j,\sigma} \partial R) \asymp \hat{\mathbb{P}}(\partial S_n \rightsquigarrow_{j,\sigma} \partial S_N), \quad (4.20)$$

and similarly with separateness conditions on the external boundary or on the internal one.

4.6 Arms in the half-plane

So far, we have been interested in arm events in the whole plane: we can define in the same way the event $B_{j,\sigma}(n, N)$ that there exist j arms that *stay in the upper half-plane* \mathbb{H} , of colors prescribed by $\sigma \in \tilde{\mathfrak{S}}_j$ and connecting $\partial S'_n$ to $\partial S'_N$, with the notation $\partial S'_n = (\partial S_n) \cap \mathbb{H}$. These events appear naturally when we look at arms near a boundary.

For the sake of completeness, let us just mention that all the results stated here remain true for arms in the half-plane. In fact, there is a natural way to order the different arms, which makes this case easier. We will not use these events in the following, and we leave the details to the reader.

5 Description of critical percolation

When studying the phase transition of percolation, the critical regime plays a very special role. It possesses a strong property of *conformal invariance* in the scaling limit. This particularity, first observed by physicists ([41; 9; 10]), has been proved by Smirnov in [46], and later extended by Camia and Newman in [11]. It allows to link the critical regime to the *SLE* processes (with parameter 6 here) introduced by Schramm in [44], and thus to use computations made for these processes ([34; 35]).

In the next sections, we will see why our description of critical percolation yields in turn a good description of near-critical percolation (which does not feature a priori any sort of conformal invariance), in particular how the characteristic functions behave through the phase transition.

5.1 Arm exponents for critical percolation

Color switching

We focus here on the probabilities of arm events at the critical point. For arms in the half-plane, a nice combinatorial argument (noticed in [3; 47]) shows that once fixed the number j of arms, prescribing the color sequence σ does not change the probability. This is the so-called “color exchange trick”:

Proposition 19. *Let $j \geq 1$ be any fixed integer. If σ, σ' are two color sequences, then for any $n'_0(j) \leq n \leq N$,*

$$\mathbb{P}_{1/2}(B_{j,\sigma}(n, N)) = \mathbb{P}_{1/2}(B_{j,\sigma'}(n, N)). \quad (5.1)$$

Proof. The proof relies on the fact that there is a canonical way to order the arms. If we condition on the i left-most arms, percolation in the remaining domain is unbiased, so that we can “flip” the sites there: for any color sequence σ , if we denote by

$$\tilde{\sigma}^{(i)} = (\sigma_1, \dots, \sigma_i, \tilde{\sigma}_{i+1}, \dots, \tilde{\sigma}_j)$$

the sequence with the same i first colors, and the remaining ones flipped, then

$$\mathbb{P}_{1/2}(B_{j,\sigma}(n,N)) = \mathbb{P}_{1/2}(B_{j,\bar{\sigma}^{(i)}}(n,N)).$$

It is not hard to convince oneself that for any two sequences σ, σ' , we can go from σ to σ' in a finite number of such operations. \square

This result is not as direct in the whole plane case, since there is no canonical ordering any more. However, the argument can be adapted to prove that the probabilities change only by a constant factor, as long as there is an interface, ie as long as σ contains at least one white arm and one black arm.

Proposition 20. *Let $j \geq 1$ be any fixed integer. If $\sigma, \sigma' \in \tilde{\mathfrak{S}}_j$ are two non-constant color sequences (ie both colors are present), then*

$$\mathbb{P}_{1/2}(A_{j,\sigma}(n,N)) \asymp \mathbb{P}_{1/2}(A_{j,\sigma'}(n,N)) \tag{5.2}$$

uniformly in $n_0(j) \leq n \leq N$.

Proof. Assume that $\sigma_1 = B$ and $\sigma_2 = W$, and fix some landing sequence I . If we replace the event $A_{j,\sigma}(n,N)$ by the strengthened event $\tilde{A}_{j,\sigma}^{I/}(n,N)$, we are allowed to condition on the black arm arriving on I_1 and on the white arm arriving on I_2 that are closest to each other: if we choose for instance I such that the point $(N, 0)$ is between I_1 and I_2 , these two arms can be determined via an exploration process starting at $(N, 0)$. We can then “flip” the remaining region. More generally, we can condition on any set of consecutive arms including these two arms, and the result follows for the same reasons as in the half-plane case. \square

We would like to stress the fact that for the reasoning, we crucially need two arms of opposite colors. In fact, the preceding result is expected to be false if σ is constant and σ' non-constant (the two probabilities *not* being of the same order of magnitude), which may seem quite surprising at first sight.

Derivation of the exponents

The link with SLE_6 makes it possible to prove the existence of the (multichromatic) “arm exponents”, and derive their values ([36; 47]), that had been predicted in the physics literature (see e.g. [3] and the references therein).

Theorem 21. *Fix some $j \geq 1$. Then for any non-constant color sequence $\sigma \in \tilde{\mathfrak{S}}_j$,*

$$\mathbb{P}_{1/2}(A_{j,\sigma}(n_0(j),N)) \approx N^{-\alpha_j} \tag{5.3}$$

when $N \rightarrow \infty$, with

- $\alpha_1 = 5/48$,
- and for $j \geq 2$, $\alpha_j = (j^2 - 1)/12$.

Let us sketch very briefly how it is proved. Consider the discrete (radial) exploration process in a unit disc: using the property of conformal invariance in the scaling limit, we can prove that this process converges toward a radial SLE_6 , for which we can compute disconnection probabilities. It implies that

$$\mathbb{P}_{1/2}(A_{j,\sigma}(\eta n, n)) \rightarrow g_j(\eta),$$

for some function $g_j(\eta) \sim \eta^{\alpha_j}$ as $\eta \rightarrow 0$. Then, the quasi-multiplicativity property in concentric annuli of fixed modulus provides the desired result.

As mentioned, this theorem is believed to be *false* for constant σ , ie when the arms are all of the same color. In this case, the probability should be smaller, or equivalently the exponent (assuming its existence) larger. Hence for each $j = 2, 3, \dots$, there are two different arm exponents, the multichromatic j -arm exponent α_j given by the previous formula (most often simply called the j -arm exponent) and the monochromatic j -arm exponent α'_j , for which no closed formula is currently known, nor even predicted. The only result proved so far concerns the case $j = 2$: as shown in [36], the monochromatic 2-arm exponent can be expressed as the leading eigenvalue of some (complicated) differential operator. Numerically, it has been found (see [3]) to be approximately $\alpha'_2 \simeq 0.35 \dots$

Note also that the derivation using SLE_6 only provides a logarithmic equivalence. However, there are reasons to believe that a stronger equivalence holds, a “ \asymp ”: for instance we know that this is the case for the “universal exponents” computed in the next sub-section.

We will often relate events to combinations of arm events, that in turn can be linked (see next section) to arm events at the critical point $p = 1/2$. It will thus be convenient to introduce the following notation, with $\sigma_j = BWBW \dots$: for any $n_0(j) \leq n < N$,

$$\pi_j(n, N) := \mathbb{P}_{1/2}(A_{j,\sigma_j}(n, N)) \tag{5.4}$$

($\asymp \mathbb{P}_{1/2}(A_{j,\sigma}(n, N))$ for any non-constant σ), and in particular

$$\pi_j(N) := \mathbb{P}_{1/2}(A_{j,\sigma_j}(n_0(j), N)) \quad (\approx N^{-\alpha_j}). \tag{5.5}$$

Note that with this notation, the a-priori bound and the quasi-multiplicativity property take the aesthetic forms

$$C_j(n/N)^{\alpha_j} \leq \pi_j(n, N) \leq C'(n/N)^{\alpha'_j}, \tag{5.6}$$

$$\text{and } \pi_j(n_1, n_2)\pi_j(n_2, n_3) \asymp \pi_j(n_1, n_3). \tag{5.7}$$

Let us mention that we can derive in the same way exponents for arms in the upper half-plane, the “half-plane exponents”:

Theorem 22. *Fix some $j \geq 1$. Then for any sequence of colors σ ,*

$$\mathbb{P}_{1/2}(B_{j,\sigma}(n'_0(j), N)) \approx N^{-\beta_j} \tag{5.8}$$

when $N \rightarrow \infty$, with

$$\beta_j = j(j+1)/6.$$

Remark 23. *As mentioned earlier, the triangular lattice is at present the only lattice for which conformal invariance in the scaling limit has been proved, and as a consequence the only lattice for which the existence and the values of the arm exponents have been established – with the noteworthy exception of the three “universal” exponents that we are going to derive.*

Note: fractality of various sets

These arm exponents can be used to measure the size (Hausdorff dimension) of various sets describing percolation clusters. In physics literature for instance (see e.g. [3]), a set S is said to be fractal of dimension D_S if the density of points in S within a box of size n decays as n^{-x_S} , with $x_S = 2 - D_S$ (in 2D). The co-dimension x_S is related to arm exponents in many cases:

- The 1-arm exponent is related to the existence of long connections, from the center of a box to its boundary. It will thus measure the size of “big” clusters, like the incipient infinite cluster (IIC) as defined by Kesten ([28]), which scales as $n^{(2-5/48)} = n^{91/48}$.
- The monochromatic 2-arm exponent describes the size of the “backbone” of a cluster. The fact that this backbone is much thinner than the cluster itself was used by Kesten [30] to prove that the random walk on the IIC is sub-diffusive (while it has been proved to converge toward a Brownian Motion on a super-critical infinite cluster).
- The multichromatic 2-arm exponent is related to the boundaries (hulls) of big clusters, which are thus of fractal dimension $2 - \alpha_2 = 7/4$.
- The 3-arm exponent concerns the external (accessible) perimeter of a cluster, which is the accessible part of the boundary: one excludes “fjords” which are connected to the exterior only by 1-site wide passages. The dimension of this frontier is $2 - \alpha_3 = 4/3$. These two latter exponents can be observed on random interfaces, numerically and in “real-life” experiments as well (see [43; 21] for instance).
- As mentioned earlier, the 4-arm exponent with alternating colors counts the pivotal (singly-connecting) sites (often called “red” sites in physics literature). This set can be viewed as the contact points between two distinct (large) clusters, its dimension is $2 - \alpha_4 = 3/4$. We will relate this exponent to the characteristic length exponent ν in Section 7.

5.2 Universal exponents

We will now examine as a complement some particular exponents, for which heuristic predictions and elementary derivations exist, namely $\beta_2 = 1$, $\beta_3 = 2$ and $\alpha_5 = 2$. They are all integers, and they were established before the complete derivation using SLE_6 (and actually they provide crucial a-priori estimates to prove the convergence toward SLE_6). Moreover, the equivalence that we get is stronger: we can replace the “ \approx ” by a “ \asymp ”.

Theorem 24. *When $N \rightarrow \infty$,*

1. *For any $\sigma \in \mathfrak{S}_2$,*

$$\mathbb{P}_{1/2}(B_{2,\sigma}(0,N)) \asymp N^{-1}.$$

2. *For any $\sigma \in \mathfrak{S}_3$,*

$$\mathbb{P}_{1/2}(B_{3,\sigma}(0,N)) \asymp N^{-2}.$$

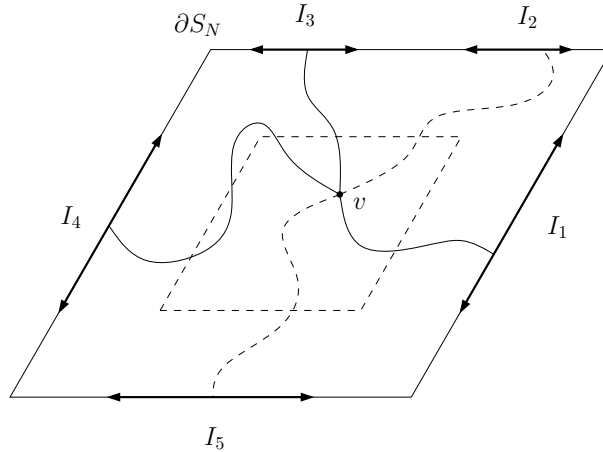

Figure 10: The landing sequence I_1, \dots, I_5 .

3. For any non-constant $\sigma \in \tilde{\mathfrak{S}}_5$,

$$\mathbb{P}_{1/2}(A_{5,\sigma}(0,N)) \asymp N^{-2}.$$

Proof. We give a complete proof only for item 3., since we will not need the two first ones – we will however sketch at the end how to derive them.

Heuristically, we can prove that the 5-arm sites can be seen as particular points on the boundary of two big black clusters, and that consequently their number is of order 1 in $S_{N/2}$. Then it suffices to use the fact that the different sites in $S_{N/2}$ produce contributions of the same order. This argument can be made rigorous by proving that the number of “macroscopic” clusters has an exponential tail: we refer to the first exercise sheet in [49] for more details. We propose here a more direct – but less elementary – proof using the separation lemmas (see [32], Lemma 5).

By color switching, it is sufficient to prove the claim for $\sigma = BWBBW$. In light of our previous results, it is clear that

$$\mathbb{P}_{1/2}(v \rightsquigarrow_{5,\sigma} \partial S_N) \asymp \mathbb{P}_{1/2}(0 \rightsquigarrow_{5,\sigma} \partial S_N)$$

uniformly in N , $v \in S_{N/2}$. It is thus enough to prove that the number of such 5-arm sites in $S_{N/2}$ is of order 1.

Let us consider the upper bound first. Take the particular landing sequence I_1, \dots, I_5 depicted on Figure 10, and consider the event

$$A_v := \{v \rightsquigarrow_{5,\sigma}^I \partial S_N\} \cap \{v \text{ is black}\}.$$

Note that $\mathbb{P}_{1/2}(A_v) = \frac{1}{2} \mathbb{P}(v \rightsquigarrow_{5,\sigma}^I \partial S_N)$ since the existence of the arms is independent of the status of v , so that $\mathbb{P}_{1/2}(A_v) \asymp \mathbb{P}_{1/2}(0 \rightsquigarrow_{5,\sigma} \partial S_N)$. We claim that A_v can occur for at most one site v . Indeed, assume that A_v and A_w occur, and denote by r_1, \dots, r_5 and r'_1, \dots, r'_5 the corresponding arms. Since $r_1 \cup r_4 \cup \{v\}$ separates I_3 from I_5 , necessarily $w \in r_1 \cup r_4 \cup \{v\}$. Similarly, $w \in r_2 \cup r_4 \cup \{v\}$: since $r_1 \cap r_2 = \emptyset$, we get that $w \in r_4 \cup \{v\}$. But only one arm can “go through” $r_3 \cup r_5$: the arm $r'_1 \cup \{w\}$ from w to I_1 has to contain v , and so does $r'_2 \cup \{w\}$. Since $r'_1 \cap r'_2 = \emptyset$, we get finally $v = w$.

Consequently,

$$1 \geq \mathbb{P}_{1/2}(\cup_{v \in S_{N/2}} A_v) = \sum_{v \in S_{N/2}} \mathbb{P}_{1/2}(A_v) \asymp N^2 \mathbb{P}_{1/2}(0 \rightsquigarrow_{5,\sigma} \partial S_N), \quad (5.9)$$

which provides the upper bound.

Let us turn to the lower bound. We perform a construction showing that a 5-arm site appears with positive probability, by using multiple applications of RSW. With a probability of at least $\delta_{16}^2 > 0$, there is a black horizontal crossing in the strip $[-N, N] \times [0, N/8]$, together with a white one in $[-N, N] \times [-N/8, 0]$. Assume this is the case, and condition on the lowest black left-right crossing c . We note that any site on this crossing has already 3 arms, 2 black arms and a white one. On the other hand, percolation in the region above it remains unbiased.

Now, still using RSW, with positive probability c is connected to the top side by a black path included in $[-N/8, 0] \times [-N, N]$, and another white path included in $[0, N/8] \times [-N, N]$. Let us assume that these paths exist, and denote by v_1 and v_2 the respective sites on c where they arrive. Let us then follow c from left to right, and consider the last vertex v before v_2 that is connected to the top side: it is not hard to see that there is a white arm from v to the top side, and that $v \in S_{N/2}$, since v is between v_1 and v_2 . Hence,

$$\mathbb{P}_{1/2}(\cup_{v \in S_{N/2}} \{v \rightsquigarrow_{5,\sigma} \partial S_N\}) \geq C \quad (5.10)$$

for some universal constant $C > 0$. Since we also have

$$\begin{aligned} \mathbb{P}_{1/2}(\cup_{v \in S_{N/2}} \{v \rightsquigarrow_{5,\sigma} \partial S_N\}) &\leq \sum_{v \in S_{N/2}} \mathbb{P}_{1/2}(v \rightsquigarrow_{5,\sigma} \partial S_N) \\ &\leq C' N^2 \mathbb{P}_{1/2}(0 \rightsquigarrow_{5,\sigma} \partial S_N), \end{aligned}$$

the desired lower bound follows.

We now explain briefly how to obtain the two half-plane exponents (items 1. and 2.). We again use the arm separation theorem, but note that [49] contains elementary proofs for them too. For the 2-arm exponent in the half-plane, we take $\sigma = BW$ and remark that if we fix two landing areas I_1 and I_2 on $\partial S'_N$, at most one site on the segment $[-N/2, N/2] \times \{0\}$ is connected by two arms to I_1 and I_2 . On the other hand, a 2-arm site can be constructed by considering a black path from $[-N/2, 0] \times \{0\}$ to I_1 and a white path from $[0, N/2] \times \{0\}$ to I_2 . Then the right-most site on $[-N/2, N/2] \times \{0\}$ connected by a black arm to I_1 is a 2-arm site. Several applications of RSW allow to conclude.

For the 3-arm exponent, we take three landing areas I_1, I_2 and I_3 , and $\sigma = BWB$. It is not hard to construct a 3-arm site by taking a black crossing from I_1 to I_3 and considering the closest to I_2 . We can then force it to be in $S_{N/2} \cap \mathbb{H}$ by a RSW construction. For the upper bound, we first notice that if we require the arms to stay strictly positive (except in the sites neighboring the origin), the probability remains of the same order of magnitude. We then use the fact that at most three sites in $S_{N/2} \cap \mathbb{H}$ are connected to the landing areas by three positive arms. \square

The proofs given here only require RSW-type considerations (including separation of arms). As a consequence, they also apply to near-critical percolation. It is clear for \mathbb{P}_p , on scales $N \leq L(p)$, but a priori only for the color sequences we have used in the proofs (resp. $\sigma = BW, BWB$ and $BWB BW -$

and of course those we can deduce from them by the symmetry $p \leftrightarrow 1 - p$): it is indeed not obvious that $\mathbb{P}_p(0 \rightsquigarrow_{5,\sigma} \partial S_N) \asymp \mathbb{P}_p(0 \rightsquigarrow_{5,\sigma'} \partial S_N)$ for two distinct non-constant σ and σ' . This is essentially Theorem 27, its proof occupies a large part of the next section.

For a general measure $\hat{\mathbb{P}}$ between \mathbb{P}_p and \mathbb{P}_{1-p} , we similarly have to be careful: we do not know whether $\hat{\mathbb{P}}(v \rightsquigarrow_{5,\sigma} \partial S_N)$ remains of the same order of magnitude when v varies. This also comes from Theorem 27, but in the course of its proof we will need an a-priori estimate on the probability of 5 arms, so temporarily we will be content with a weaker statement that does not use its conclusion:

Lemma 25. *For $\sigma = BWBBW (= \sigma_5)$, we have uniformly in p , $\hat{\mathbb{P}}$ between \mathbb{P}_p and \mathbb{P}_{1-p} and $N \leq L(p)$:*

$$\sum_{v \in S_{N/2}} \hat{\mathbb{P}}(v \rightsquigarrow_{5,\sigma} \partial S_N) \asymp \sum_{v \in S_{N/8}} \hat{\mathbb{P}}(v \rightsquigarrow_{5,\sigma} \partial S_N) \asymp 1. \quad (5.11)$$

Remark 26. *We would like to mention that these estimates for critical and near-critical percolation remain also valid on other lattices, like the square lattice (see the discussion in the last section) – at least for the color sequences that we have used in the proofs, no analog of the color exchange trick being available (to our knowledge).*

6 Arm events near criticality

6.1 Statement of the theorem

We would like now to study how the events $A_{j,\sigma}(n, N)$ are affected by a variation of the parameter p . We have defined $L(p)$ in terms of crossing events to be the scale on which percolation can be considered as (approximately) critical, we would thus expect the probabilities of these events not to vary too much if n, N remain below $L(p)$. This is what happens:

Theorem 27. *Let $j \geq 1$, $\sigma \in \tilde{\mathfrak{S}}_j$ be as usual. Then we have*

$$\hat{\mathbb{P}}(A_{j,\sigma}(n, N)) \asymp \hat{\mathbb{P}}'(A_{j,\sigma}(n, N)) \quad (6.1)$$

uniformly in p , $\hat{\mathbb{P}}$ and $\hat{\mathbb{P}}'$ between \mathbb{P}_p and \mathbb{P}_{1-p} , and $n_0(j) \leq n \leq N \leq L(p)$.

Note that if we take in particular $\hat{\mathbb{P}}' = \mathbb{P}_{1/2}$, we get that below the scale $L(p)$, the arm events remain roughly the same as at criticality:

$$\hat{\mathbb{P}}(A_{j,\sigma}(n, N)) \asymp \mathbb{P}_{1/2}(A_{j,\sigma}(n, N)).$$

This will be important to derive the critical exponents for the characteristic functions from the arm exponents at criticality.

Remark 28. *Note that the property of exponential decay with respect to $L(p)$ (Lemma 39), proved in Section 7.4, shows that we cannot hope for a similar result on a much larger range, so that $L(p)$ is the appropriate scale here: consider for instance \mathbb{P}_p with $p > 1/2$, the probability to observe a white arm tends to 0 exponentially fast (and thus much faster than at the critical point), while the probability to observe a certain number of disjoint black arms tends to a positive constant.*

6.2 Proof of the theorem

We want to compare the value of $\hat{\mathbb{P}}(A_{j,\sigma}(n,N))$ for different measures $\hat{\mathbb{P}}$. A natural way of doing this is to go from one to the other by using Russo's formula (Theorem 1). But since for $j \geq 2$ and non-constant σ , the event $A_{j,\sigma}(n,N)$ is not monotone, we need a slight generalization of this formula, for events that can be expressed as the intersection of two monotone events, one increasing and one decreasing. We also allow the parameters p_v to be differentiable functions of $t \in [0, 1]$.

Lemma 29. *Let A^+ and A^- be two monotone events, respectively increasing and decreasing, depending only on the sites contained in some finite set of vertices S . Let $(\hat{p}_v)_{v \in S}$ be a family of differentiable functions $\hat{p}_v : t \in [0, 1] \mapsto \hat{p}_v(t) \in [0, 1]$, and denote by $(\hat{\mathbb{P}}_t)_{0 \leq t \leq 1}$ the associated product measures. Then*

$$\begin{aligned} & \frac{d}{dt} \hat{\mathbb{P}}_t(A^+ \cap A^-) \\ &= \sum_{v \in S} \frac{d}{dt} \hat{p}_v(t) \left[\hat{\mathbb{P}}_t(v \text{ is pivotal for } A^+ \text{ but not for } A^-, \text{ and } A^- \text{ occurs}) \right. \\ & \quad \left. - \hat{\mathbb{P}}_t(v \text{ is pivotal for } A^- \text{ but not for } A^+, \text{ and } A^+ \text{ occurs}) \right]. \end{aligned}$$

Proof. We adapt the proof of standard Russo's formula. We use the same function \mathscr{P} of the parameters $(\hat{p}_v)_{v \in S}$, and we note that for a small variation $\epsilon > 0$ in w ,

$$\begin{aligned} & \hat{\mathbb{P}}^{+\epsilon}(A^+ \cap A^-) - \hat{\mathbb{P}}(A^+ \cap A^-) \\ &= \epsilon \times \hat{\mathbb{P}}(w \text{ is pivotal for } A^+ \text{ but not for } A^-, \text{ and } A^- \text{ occurs}) \\ & \quad - \epsilon \times \hat{\mathbb{P}}(w \text{ is pivotal for } A^- \text{ but not for } A^+, \text{ and } A^+ \text{ occurs}). \end{aligned}$$

Now, it suffices to compute the derivative of the function $t \mapsto \hat{\mathbb{P}}_t(A^+ \cap A^-)$ by writing it as the composition of $t \mapsto (\hat{p}_v(t))$ and $(\hat{p}_v)_{v \in S} \mapsto \hat{\mathbb{P}}(A)$. \square

Remark 30. *Note that if we take $A^- = \Omega$ in Lemma 29, we get usual Russo's formula for A^+ , with parameters that can be functions of t .*

Proof of the theorem. We now turn to the proof itself. It is divided into three main steps.

1. First simplifications

Note first that by quasi-multiplicativity, we can restrict ourselves to $n = n_0(j)$. It also suffices to prove the result for some fixed $\hat{\mathbb{P}}'$, with $\hat{\mathbb{P}}$ varying: we thus assume that $p < 1/2$, and take $\hat{\mathbb{P}}' = \mathbb{P}_p$. Denoting by \hat{p}_v the parameters of $\hat{\mathbb{P}}$, we have by hypothesis $\hat{p}_v \geq p$ for each site v . For technical reasons, we suppose that the sizes of annuli are powers of two: take k_0, K such that $2^{k_0-1} < n_0 \leq 2^{k_0}$ and $2^K \leq N < 2^{K+1}$, then

$$\mathbb{P}_p(A_{j,\sigma}(n_0, N)) \asymp \mathbb{P}_p(A_{j,\sigma}(2^{k_0}, 2^K))$$

and the same is true for $\hat{\mathbb{P}}$.

To estimate the change in probability when p is replaced by \hat{p}_v , we will use the observation that the pivotal sites give rise to 4 alternating arms locally (see Figure 11). However, this does not work so

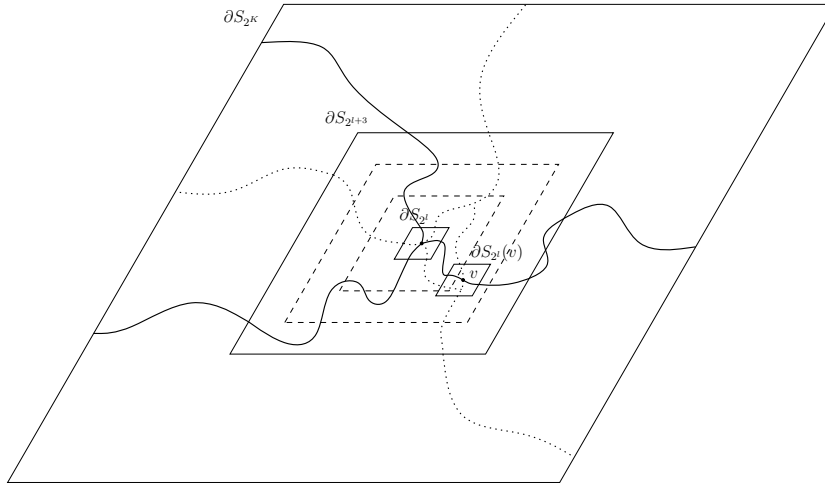

Figure 11: If v is pivotal, 4 alternating arms arise locally.

nicely for the sites v which are close to $\partial S_{2^{k_0}}$ or ∂S_{2^k} , so for the sake of simplicity we treat aside these sites. We perform the change $p \rightsquigarrow \hat{p}_v$ in $S_{2^{k_0}, 2^k} \setminus S_{2^{k_0+3}, 2^{k-3}}$. Note that the intermediate measure $\tilde{\mathbb{P}}$ so obtained is between \mathbb{P}_p and \mathbb{P}_{1-p} , and that $\tilde{\mathbb{P}}(A_{j,\sigma}(2^{k_0+3}, 2^{k-3})) = \mathbb{P}_p(A_{j,\sigma}(2^{k_0+3}, 2^{k-3}))$. We have

$$\tilde{\mathbb{P}}(A_{j,\sigma}(2^{k_0}, 2^k)) \asymp \tilde{\mathbb{P}}(A_{j,\sigma}(2^{k_0+3}, 2^{k-3})) \quad (6.2)$$

and also

$$\mathbb{P}_p(A_{j,\sigma}(2^{k_0}, 2^k)) \asymp \mathbb{P}_p(A_{j,\sigma}(2^{k_0+3}, 2^{k-3})), \quad (6.3)$$

which shows that it would be enough to prove the result with $\tilde{\mathbb{P}}$ instead of \mathbb{P}_p .

2. Make appear the logarithmic derivative of the probability by applying Russo's formula

The event $A_{j,\sigma}(2^{k_0}, 2^k)$ cannot be directly written as an intersection like in Russo's formula, since the order of the different arms is prescribed. To fix this difficulty, we impose the landing areas of the different arms on ∂S_{2^k} , ie we fix some landing sequence $I' = I'_1, \dots, I'_j$ and we consider the event $\bar{A}_{j,\sigma}^{I'}(2^{k_0}, 2^k)$. Since we know that

$$\tilde{\mathbb{P}}(A_{j,\sigma}(2^{k_0}, 2^k)) \asymp \tilde{\mathbb{P}}(\bar{A}_{j,\sigma}^{I'}(2^{k_0}, 2^k)), \quad (6.4)$$

and also with $\hat{\mathbb{P}}$ instead of $\tilde{\mathbb{P}}$, it is enough to prove the result for this particular landing sequence.

We study successively three cases. We begin with the case of one arm, which is slightly more direct than the two next ones – however, only small adaptations are needed. We then consider the special case where j is even and σ alternating: due to the fact that any arm is surrounded by two arms of opposite color, the local four arms are always long enough. We finally prove the result for any j and any σ : a technical complication arises in this case, for which the notion of “arms with defects” is needed.

Case 1: $j = 1$

We first consider the case of one arm, and assume for instance $\sigma = B$. We introduce the family of measures $(\tilde{\mathbb{P}}_t)_{t \in [0,1]}$ with parameters

$$\tilde{p}_v(t) = t\hat{p}_v + (1-t)p \quad (6.5)$$

in $S_{2^{k_0+3}, 2^{K-3}}$, corresponding to a linear interpolation between p and \hat{p}_v . For future use, note that $\tilde{\mathbb{P}}_t$ is between \mathbb{P}_p and \mathbb{P}_{1-p} for any $t \in [0,1]$. We have $\frac{d}{dt}\tilde{p}_v(t) = \hat{p}_v - p$ if $v \in S_{2^{k_0+3}, 2^{K-3}}$ (and 0 otherwise), generalized Russo's formula (with just an increasing event – see Remark 30) thus gives:

$$\frac{d}{dt}\tilde{\mathbb{P}}_t(\bar{A}_{1,\sigma}^{/I'}(2^{k_0}, 2^K)) = \sum_{v \in S_{2^{k_0+3}, 2^{K-3}}} (\hat{p}_v - p)\tilde{\mathbb{P}}_t(v \text{ is pivotal for } \bar{A}_{1,\sigma}^{/I'}(2^{k_0}, 2^K)).$$

The key remark is that the summand can be expressed in terms of arm events: for probabilities, being pivotal is approximately the same as having a black arm, and four arms locally around v . Indeed, $[v \text{ is pivotal for } \bar{A}_{1,\sigma}^{/I'}(2^{k_0}, 2^K)]$ iff

- (1) there exists an arm r_1 from $\partial S_{2^{k_0}}$ to I'_1 , with $v \in r_1$; r_1 is black, with a possible exception in v ($\bar{A}_{1,\sigma}^{/I'}(2^{k_0}, 2^K)$ occurs when v is black),
- (2) there exists a path c_1 passing through v and separating $\partial S_{2^{k_0}}$ from I'_1 (c_1 may be either a circuit around $\partial S_{2^{k_0}}$ or a path with extremities on ∂S_{2^k}); c_1 is white, except possibly in v (there is no black arm from $\partial S_{2^{k_0}}$ to I'_1 when v is white).

We now put a rhombus $R(v)$ around v : if it does not contain 0, then v is connected to $\partial R(v)$ by 4 arms of alternating colors. Indeed, r_1 provides two black arms, and c_1 two white arms.

Let us look at the pieces of the black arm outside of $R(v)$: if $R(v)$ is not too large, we can expect them to be sufficiently large to enable us to reconstitute the whole arm. We also would like that the two white arms are a good approximation of the whole circuit. We thus take $R(v)$ of size comparable to the distance $d(0, v)$: if $2^{l+1} < \|v\|_\infty \leq 2^{l+2}$, we take $R(v) = S_{2^l}(v)$. It is not hard to check that $R(v) \subseteq S_{2^l, 2^{l+3}}$ for this particular choice of $R(v)$ (see Figure 11), so that for any $t \in [0,1]$,

$$\begin{aligned} \tilde{\mathbb{P}}_t(v \text{ is pivotal for } \bar{A}_{1,\sigma}^{/I'}(2^{k_0}, 2^K)) \\ \leq \tilde{\mathbb{P}}_t(\{\partial S_{2^{k_0}} \rightsquigarrow \partial S_{2^l}\} \cap \{\partial S_{2^{l+3}} \rightsquigarrow \partial S_{2^K}\} \cap \{v \rightsquigarrow_{4,\sigma_4} \partial S_{2^l}(v)\}) \\ = \tilde{\mathbb{P}}_t(\partial S_{2^{k_0}} \rightsquigarrow \partial S_{2^l})\tilde{\mathbb{P}}_t(\partial S_{2^{l+3}} \rightsquigarrow \partial S_{2^K})\tilde{\mathbb{P}}_t(v \rightsquigarrow_{4,\sigma_4} \partial S_{2^l}(v)) \end{aligned}$$

by independence of the three events, since they are defined in terms of sites in disjoint sets (recall that $\sigma_4 = BWBW$). We can then make appear the original event by combining the two first terms, using quasi-multiplicativity and extendability²:

$$\tilde{\mathbb{P}}_t(\partial S_{2^{k_0}} \rightsquigarrow \partial S_{2^l})\tilde{\mathbb{P}}_t(\partial S_{2^{l+3}} \rightsquigarrow \partial S_{2^K}) \leq C_2\tilde{\mathbb{P}}_t(\bar{A}_{1,\sigma}^{/I'}(2^{k_0}, 2^K)) \quad (6.6)$$

for some C_2 universal. Hence³,

$$\tilde{\mathbb{P}}_t(v \text{ is pivotal for } \bar{A}_{1,\sigma}^{/I'}(2^{k_0}, 2^K)) \leq C_2\tilde{\mathbb{P}}_t(\bar{A}_{1,\sigma}^{/I'}(2^{k_0}, 2^K))\tilde{\mathbb{P}}_t(v \rightsquigarrow_{4,\sigma_4} \partial S_{2^l}(v)). \quad (6.7)$$

²Note that in the case of one arm, the extendability property, as well as the quasi-multiplicativity, are direct consequences of RSW and do not require the separation lemmas.

³As we will see in the next sub-section (Proposition 32), the converse bound also holds: the estimate obtained gives the exact order of magnitude for the summand.

We thus get

$$\begin{aligned} \frac{d}{dt} \tilde{\mathbb{P}}_t(\bar{A}_{1,\sigma}^{\prime} / (2^{k_0}, 2^K)) \\ \leq C_2 \sum_{v \in S_{2^{k_0+3}, 2^{K-3}}} (\hat{p}_v - p) \tilde{\mathbb{P}}_t(\bar{A}_{1,\sigma}^{\prime} / (2^{k_0}, 2^K)) \tilde{\mathbb{P}}_t(v \rightsquigarrow_{4,\sigma_4} \partial S_{2^l}(v)). \end{aligned}$$

Now, dividing by $\tilde{\mathbb{P}}_t(\bar{A}_{1,\sigma}^{\prime} / (2^{k_0}, 2^K))$, we make appear its logarithmic derivative in the left-hand side,

$$\frac{d}{dt} \log [\tilde{\mathbb{P}}_t(\bar{A}_{1,\sigma}^{\prime} / (2^{k_0}, 2^K))] \leq C_2 \sum_{v \in S_{2^{k_0+3}, 2^{K-3}}} (\hat{p}_v - p) \tilde{\mathbb{P}}_t(v \rightsquigarrow_{4,\sigma_4} \partial S_{2^l}(v)), \quad (6.8)$$

it thus suffices to show that for some C_3 universal,

$$\int_0^1 \sum_{v \in S_{2^{k_0+3}, 2^{K-3}}} (\hat{p}_v - p) \tilde{\mathbb{P}}_t(v \rightsquigarrow_{4,\sigma_4} \partial S_{2^l}(v)) dt \leq C_3. \quad (6.9)$$

We will prove this in the next step, but before that, we turn to the two other cases: even if the computations need to be modified, it is still possible to reduce the proof to this inequality.

Case 2: j even and σ alternating

In this case,

$$\bar{A}_{j,\sigma}^{\prime} / (2^{k_0}, 2^K) = A^+ \cap A^- \quad (6.10)$$

with $A^+ = A^+(2^{k_0}, 2^K) = \{\text{There exist } j/2 \text{ disjoint black arms } r_1 : \partial S_{2^{k_0}} \rightsquigarrow I'_1, r_3 : \partial S_{2^{k_0}} \rightsquigarrow I'_3 \dots\}$
and $A^- = A^-(2^{k_0}, 2^K) = \{\text{There exist } j/2 \text{ disjoint white arms } r_2 : \partial S_{2^{k_0}} \rightsquigarrow^* I'_2, r_4 : \partial S_{2^{k_0}} \rightsquigarrow^* I'_4 \dots\}$.

We then perform the change $p \rightsquigarrow \hat{p}_v$ in $S_{2^{k_0+3}, 2^{K-3}}$ linearly as before (Eq.(6.5)), which gives rise to the family of measures $(\tilde{\mathbb{P}}_t)_{t \in [0,1]}$, and generalized Russo's formula reads

$$\begin{aligned} \frac{d}{dt} \tilde{\mathbb{P}}_t(\bar{A}_{j,\sigma}^{\prime} / (2^{k_0}, 2^K)) \\ = \sum_{v \in S_{2^{k_0+3}, 2^{K-3}}} (\hat{p}_v - p) \left[\tilde{\mathbb{P}}_t(v \text{ is pivotal for } A^+ \text{ but not for } A^-, \text{ and } A^- \text{ occurs}) \right. \\ \left. - \tilde{\mathbb{P}}_t(v \text{ is pivotal for } A^- \text{ but not for } A^+, \text{ and } A^+ \text{ occurs}) \right]. \end{aligned}$$

We note that $[v \text{ is pivotal for } A^+(2^{k_0}, 2^K) \text{ but not for } A^-(2^{k_0}, 2^K), \text{ and } A^-(2^{k_0}, 2^K) \text{ occurs}]$ iff for some $i' \in \{1, 3, \dots, j-1\}$,

- (1) there exist j disjoint monochromatic arms r_1, \dots, r_j from $\partial S_{2^{k_0}}$ to I'_1, \dots, I'_j , with $v \in r_{i'}$; r_2, r_4, \dots are white, and r_1, r_3, \dots are black, with a possible exception for $r_{i'}$ in v (the event $\bar{A}_{j,\sigma}^{\prime} / (2^{k_0}, 2^K)$ is satisfied when v is black),
- (2) there exists a path $c_{i'}$ separating $\partial S_{2^{k_0}}$ from $I'_{i'}$; this path is white, except possibly in v ($\partial S_{2^{k_0}}$ and $I'_{i'}$ are separated when v is white).

If we take the same rhombus $R(v) \subseteq S_{2^l, 2^{l+3}}$ around v , then v is still connected to $\partial R(v)$ by 4 arms of alternating colors. Indeed, $r_{i'}$ provides two black arms, and $c_{i'}$ (which can contain parts of $r_{i'-1}$ or $r_{i'+1}$ – see Figure 11) provides the two white arms.

Hence for any $t \in [0, 1]$,

$$\begin{aligned} & \tilde{\mathbb{P}}_t(v \text{ is pivotal for } A^+ \text{ but not for } A^-, \text{ and } A^- \text{ occurs}) \\ & \leq \tilde{\mathbb{P}}_t(A_{j,\sigma}(2^{k_0}, 2^l) \cap \bar{A}_{j,\sigma}^{/l'}(2^{l+3}, 2^K) \cap \{v \rightsquigarrow_{4,\sigma_4} \partial S_{2^l}(v)\}) \\ & = \tilde{\mathbb{P}}_t(A_{j,\sigma}(2^{k_0}, 2^l)) \tilde{\mathbb{P}}_t(\bar{A}_{j,\sigma}^{/l'}(2^{l+3}, 2^K)) \tilde{\mathbb{P}}_t(v \rightsquigarrow_{4,\sigma_4} \partial S_{2^l}(v)) \end{aligned}$$

by independence of the three events. We then combine the two first terms using extendability and quasi-multiplicativity:

$$\tilde{\mathbb{P}}_t(A_{j,\sigma}(2^{k_0}, 2^l)) \tilde{\mathbb{P}}_t(\bar{A}_{j,\sigma}^{/l'}(2^{l+3}, 2^K)) \leq C_1 \tilde{\mathbb{P}}_t(\bar{A}_{j,\sigma}^{/l'}(2^{k_0}, 2^K)) \quad (6.11)$$

for some C_1 universal. We thus obtain

$$\begin{aligned} & \tilde{\mathbb{P}}_t(v \text{ is pivotal for } A^+ \text{ but not for } A^-, \text{ and } A^- \text{ occurs}) \\ & \leq C_1 \tilde{\mathbb{P}}_t(\bar{A}_{j,\sigma}^{/l'}(2^{k_0}, 2^K)) \tilde{\mathbb{P}}_t(v \rightsquigarrow_{4,\sigma_4} \partial S_{2^l}(v)). \end{aligned}$$

If we then do the same manipulation on the second term of the sum, we get

$$\begin{aligned} & \left| \frac{d}{dt} \tilde{\mathbb{P}}_t(\bar{A}_{j,\sigma}^{/l'}(2^{k_0}, 2^K)) \right| \\ & \leq 2C_1 \sum_{v \in S_{2^{k_0+3}, 2^{K-3}}} (\hat{p}_v - p) \tilde{\mathbb{P}}_t(\bar{A}_{j,\sigma}^{/l'}(2^{k_0}, 2^K)) \tilde{\mathbb{P}}_t(v \rightsquigarrow_{4,\sigma_4} \partial S_{2^l}(v)), \end{aligned}$$

and if we divide by $\tilde{\mathbb{P}}_t(\bar{A}_{j,\sigma}^{/l'}(2^{k_0}, 2^K))$,

$$\left| \frac{d}{dt} \log [\tilde{\mathbb{P}}_t(\bar{A}_{j,\sigma}^{/l'}(2^{k_0}, 2^K))] \right| \leq 2C_1 \sum_{v \in S_{2^{k_0+3}, 2^{K-3}}} (\hat{p}_v - p) \tilde{\mathbb{P}}_t(v \rightsquigarrow_{4,\sigma_4} \partial S_{2^l}(v)). \quad (6.12)$$

As promised, we have thus reduced this case to Eq.(6.9).

Case 3: Any j, σ

In the general case, a minor complication may arise, coming from consecutive arms of the same color: indeed, the property of being pivotal for a site v does not always give rise to four arms in $R(v)$, but to some more complex event $E(v)$ (see Figure 12). If v is on r_i , and this arm is black for instance, there are still two black arms coming from r_i , but the two white arms do not necessarily reach $\partial R(v)$, since they can encounter neighboring black arms.

We first introduce an event for which the property of being pivotal is easier to formulate. We group consecutive arms of the same color in “packs”: if $(r_{i_q}, r_{i_q+1}, \dots, r_{i_q+l_q-1})$ is such a sequence of arms, say black, we take an interval \tilde{I}_q covering all the I_i for $i_q \leq i \leq i_q + l_q - 1$ and replace the condition “ $r_i \rightsquigarrow I_i$ for all $i_q \leq i \leq i_q + l_q - 1$ ” by “ $r_i \rightsquigarrow \tilde{I}_q$ for all $i_q \leq i \leq i_q + l_q - 1$ ”. We construct in this way an event $\tilde{A} = \tilde{A}^+ \cap \tilde{A}^-$: since it is intermediate between $\bar{A}_{j,\sigma}^{/l'}(2^{k_0}, 2^K)$ and $A_{j,\sigma}(2^{k_0}, 2^K)$, we have

$$\tilde{\mathbb{P}}_t(\tilde{A}) \asymp \tilde{\mathbb{P}}_t(\bar{A}_{j,\sigma}^{/l'}(2^{k_0}, 2^K)).$$

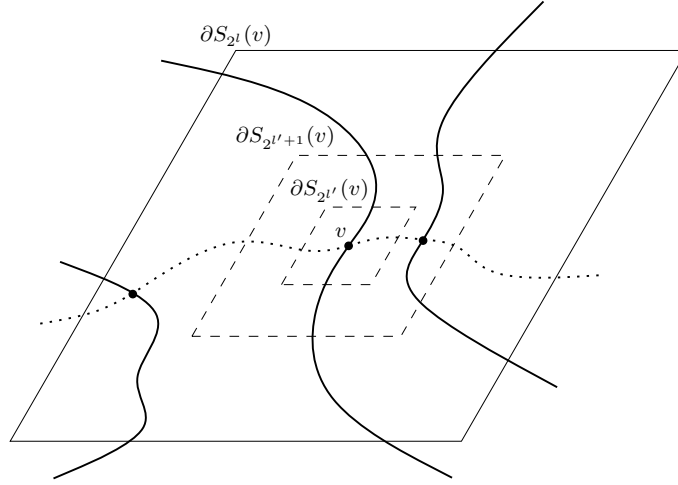

Figure 12: More complex events may arise when σ is not alternating.

This new definition allows to use Menger's theorem (see [22], Theorem 3.3.1): [v is pivotal for \tilde{A}^+ but not for \tilde{A}^- , and \tilde{A}^- occurs] iff for some arm $r_{i'}$ in a black pack $(r_{i_q}, r_{i_q+1}, \dots, r_{i_q+l_q-1})$,

- (1) there exist j disjoint monochromatic arms r_1, \dots, r_j from $\partial S_{2^{k_0}}$ to \tilde{I}_q (an appropriate number of arms for each of these intervals), with $v \in r_{i'}$; all of these arms are of the prescribed color, with a possible exception for $r_{i'}$ in v (\tilde{A} occurs when v is black),
- (2) there exists a path $c_{i'}$ separating $\partial S_{2^{k_0}}$ from \tilde{I}_q ; this path is white, except in (at most) $l_q - 1$ sites, and also possibly in v ($\partial S_{2^{k_0}}$ and \tilde{I}_q can be separated by turning white $l_q - 1$ sites when v is white).

Now, we take once again the same rhombus $R(v) \subseteq S_{2^l, 2^{l+3}}$ around v : if there are four arms $v \rightsquigarrow_{4, \sigma_4} \partial S_{2^{l-1}}(v)$, we are OK. Otherwise, if l' , $1 \leq l' \leq l - 2$, is such that the defect on $c_{i'}$ closest to v is in $S_{2^{l'+1}}(v) \setminus S_{2^{l'}}(v)$, then there are 4 alternating arms $v \rightsquigarrow_{4, \sigma_4} \partial S_{2^{l'}}(v)$, and also 6 arms $\partial S_{2^{l'+1}}(v) \rightsquigarrow_{6, \sigma'_6}^{(j)} \partial S_{2^l}(v)$ having at most j defects, with the notation $\sigma'_6 = BBWBBW$. We denote by $E(v)$ the corresponding event: $E(v) := \{\text{There exists } l' \in \{1, \dots, l - 2\} \text{ such that } v \rightsquigarrow_{4, \sigma_4} \partial S_{2^{l'}}(v) \text{ and } \partial S_{2^{l'+1}}(v) \rightsquigarrow_{6, \sigma'_6}^{(j)} \partial S_{2^l}(v)\} \cup \{v \rightsquigarrow_{4, \sigma_4} \partial S_{2^{l-1}}(v)\}$.

For the 6 arms with defects, Proposition 18 applies and the probability remains roughly the same, with just an extra logarithmic correction:

$$\begin{aligned}
& \tilde{\mathbb{P}}_t(\partial S_{2^{l'+1}}(v) \rightsquigarrow_{6, \sigma'_6}^{(j)} \partial S_{2^l}(v)) \\
& \leq C_1(l - l')^j \tilde{\mathbb{P}}_t(\partial S_{2^{l'+1}}(v) \rightsquigarrow_{6, \sigma'_6} \partial S_{2^l}(v)) \\
& \leq C_1(l - l')^j \tilde{\mathbb{P}}_t(\partial S_{2^{l'+1}}(v) \rightsquigarrow_{4, \sigma_4} \partial S_{2^l}(v)) \tilde{\mathbb{P}}_t(\partial S_{2^{l'+1}}(v) \rightsquigarrow_{2, BB} \partial S_{2^l}(v)) \\
& \leq C_2(l - l')^j \tilde{\mathbb{P}}_t(\partial S_{2^{l'+1}}(v) \rightsquigarrow_{4, \sigma_4} \partial S_{2^l}(v)) 2^{-\alpha'(l-l')}
\end{aligned}$$

using Reimer's inequality (its consequence Eq.(4.2)) and the a-priori bound for one arm (Eq.(4.10)).

This implies that

$$\tilde{\mathbb{P}}_t(E(v)) \leq C_5 \tilde{\mathbb{P}}_t(v \rightsquigarrow_{4,\sigma_4} \partial S_{2^l}(v)) \quad (6.13)$$

for some universal constant C_5 : indeed, by quasi-multiplicativity,

$$\begin{aligned} & \sum_{l'=1}^{l-2} \tilde{\mathbb{P}}_t(v \rightsquigarrow_{4,\sigma_4} \partial S_{2^{l'}}(v)) \tilde{\mathbb{P}}_t(\partial S_{2^{l'+1}}(v) \rightsquigarrow_{6,\sigma_6}^{(j)} \partial S_{2^l}(v)) \\ & \leq C_2 \sum_{l'=1}^{l-2} \tilde{\mathbb{P}}_t(v \rightsquigarrow_{4,\sigma_4} \partial S_{2^{l'}}(v)) \tilde{\mathbb{P}}_t(\partial S_{2^{l'+1}}(v) \rightsquigarrow_{4,\sigma_4} \partial S_{2^l}(v)) (l-l')^j 2^{-\alpha'(l-l')} \\ & \leq C_3 \tilde{\mathbb{P}}_t(v \rightsquigarrow_{4,\sigma_4} \partial S_{2^l}(v)) \sum_{l'=1}^{l-2} (l-l')^j 2^{-\alpha'(l-l')} \\ & \leq C_4 \tilde{\mathbb{P}}_t(v \rightsquigarrow_{4,\sigma_4} \partial S_{2^l}(v)), \end{aligned}$$

since $\sum_{l'=1}^{l-2} (l-l')^j 2^{-\alpha'(l-l')} \leq \sum_{r=1}^{\infty} r^j 2^{-\alpha' r} < \infty$.

The reasoning is then identical:

$$\begin{aligned} & \tilde{\mathbb{P}}_t(v \text{ is pivotal for } \tilde{A}^+ \text{ but not for } \tilde{A}^-, \text{ and } \tilde{A}^- \text{ occurs}) \\ & \leq \tilde{\mathbb{P}}_t(A_{j,\sigma}(2^{k_0}, 2^l)) \tilde{\mathbb{P}}_t(A_{j,\sigma}(2^{l+3}, 2^K)) \tilde{\mathbb{P}}_t(E(v)) \\ & \leq C_6 \tilde{\mathbb{P}}_t(A_{j,\sigma}(2^{k_0}, 2^K)) \tilde{\mathbb{P}}_t(v \rightsquigarrow_{4,\sigma_4} \partial S_{2^l}(v)), \end{aligned}$$

and using $\tilde{\mathbb{P}}_t(A_{j,\sigma}(2^{k_0}, 2^K)) \leq C_7 \tilde{\mathbb{P}}_t(\tilde{A})$, we get

$$\left| \frac{d}{dt} \log [\tilde{\mathbb{P}}_t(\tilde{A})] \right| \leq C_8 \sum_{v \in S_{2^{k_0+3}, 2^{K-3}}} (\hat{p}_v - p) \tilde{\mathbb{P}}_t(v \rightsquigarrow_{4,\sigma_4} \partial S_{2^l}(v)). \quad (6.14)$$

Once again, Eq.(6.9) would be sufficient.

3. Final summation

We now prove Eq.(6.9), ie that for some universal constant C_1 ,

$$\int_0^1 \sum_{v \in S_{2^{k_0+3}, 2^{K-3}}} (\hat{p}_v - p) \tilde{\mathbb{P}}_t(v \rightsquigarrow_{4,\sigma_4} \partial S_{2^l}(v)) dt \leq C_1. \quad (6.15)$$

Recall that Russo's formula allows to count 4-arm sites: for any N and any measure $\bar{\mathbb{P}}$ between \mathbb{P}_p and \mathbb{P}_{1-p} ,

$$\int_0^1 \sum_{v \in S_N} (\bar{p}_v - p) \bar{\mathbb{P}}_t(v \rightsquigarrow_{4,\sigma_4}^{\bar{I}} \partial S_N) dt = \bar{\mathbb{P}}(\mathcal{C}_H(S_N)) - \mathbb{P}_p(\mathcal{C}_H(S_N)) \leq 1 \quad (6.16)$$

(we remind that \bar{I} consists of the different sides of ∂S_N). This is essentially the only relation we have at our disposal, the end of the proof consists in using it in a clever way.

Roughly speaking, when applied to $N = L(p)$, this relation gives that $(p - 1/2)N^2\pi_4(N) \leq 1$, since all the sites give a contribution of order

$$\tilde{\mathbb{P}}_t(0 \rightsquigarrow_{4,\sigma_4} \partial S_{N/2}) \asymp \pi_4(N). \quad (6.17)$$

This corresponds more or less to the sites in the “external annulus” in Eq.(6.15). Now each time we get from an annulus to the next inside it, the probability to have 4 arms is multiplied by $2^{\alpha_4} \approx 2^{5/4}$, while the number of sites is divided by 4, so that things decay exponentially fast, and the sum of Eq.(6.15) is bounded by something like

$$\sum_{j=k_0+3}^{K-4} (2^{5/4-2})^{K-4-j} \leq \sum_{q=0}^{\infty} (2^{-3/4})^q < \infty.$$

We have to be more cautious, in particular Eq.(6.17) does not trivially hold, since we do not know at this point that the probability of having 4 arms remains of the same order on a scale $L(p)$ (and the estimate for 4 arms only gives a logarithmic equivalence). The a-priori estimate coming from the 5-arm exponent will allow us to circumvent these difficulties. We also need to take care of the boundary effects.

Assume that $v \in S_{2^{l+1}, 2^{l+2}}$ as before. We subdivide this annulus into 12 sub-boxes of size 2^{l+1} (see Figure 13) $\tilde{R}_{2^{l+1}}^i$ ($i = 1, \dots, 12$). At least one of these boxes contains v : we denote it by $\tilde{R}(v)$. We then associate to each of these boxes a slightly enlarged box $\tilde{R}_{2^{l+1}}^i$ of size 2^{l+2} , and we also use the obvious notation $\tilde{R}'(v)$. Since

$$\{v \rightsquigarrow_{4,\sigma_4} \partial S_{2^{l+2}}(v)\} \subseteq \{v \rightsquigarrow_{4,\sigma_4} \partial \tilde{R}'(v)\} \subseteq \{v \rightsquigarrow_{4,\sigma_4} \partial S_{2^l}(v)\},$$

we have

$$\tilde{\mathbb{P}}_t(v \rightsquigarrow_{4,\sigma_4} \partial S_{2^l}(v)) \asymp \tilde{\mathbb{P}}_t(v \rightsquigarrow_{4,\sigma_4} \partial \tilde{R}'(v)).$$

We thus have to find an upper bound for

$$\sum_{j=k_0+3}^{K-4} \sum_{i=1}^{12} \int_0^1 \sum_{v \in \tilde{R}_{2^j}^i} (\hat{p}_v - p) \tilde{\mathbb{P}}_t(v \rightsquigarrow_{4,\sigma_4} \partial \tilde{R}_{2^j}^i) dt. \quad (6.18)$$

For that purpose, we will prove that for $i = 1, \dots, 12$, and fixed $t \in [0, 1]$,

$$S_j^{i,(4)} := \sum_{v \in \tilde{R}_{2^j}^i} (\hat{p}_v - p) \tilde{\mathbb{P}}_t(v \rightsquigarrow_{4,\sigma_4} \partial \tilde{R}_{2^j}^i)$$

indeed decays fast when, starting from $j = K - 4$, we make j decrease. For that, we duplicate the parameters in the box $\tilde{R}_{2^j}^i$ periodically inside $S_{2^{K-3}}$: this gives rise to a new measure $\tilde{\mathbb{P}}$ inside S_{2^K} (to completely define it, simply take $\bar{p}_v = p$ outside of $S_{2^{K-3}}$). This measure contains $2^{2(K-j-3)}$ copies of the original box (of size 2^{j+1}), that we denote by (\tilde{R}'_q) . We also consider \tilde{R}'_q the box of size 2^j centered inside \tilde{R}'_q . We know that

$$\int_0^1 \sum_{v \in S_{2^{K-3}}} (\bar{p}_v - p) \tilde{\mathbb{P}}_t(v \rightsquigarrow_{4,\sigma_4} \partial S_{2^K}) dt \leq 1. \quad (6.19)$$

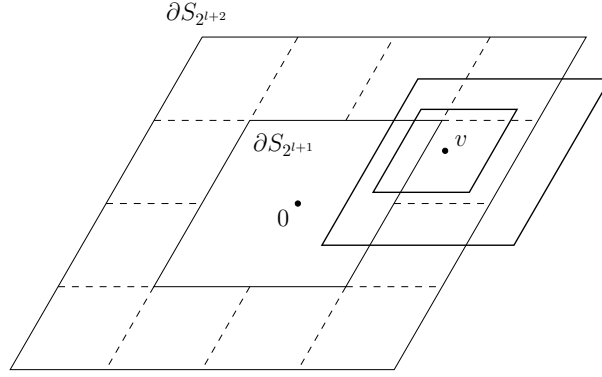

Figure 13: We replace $R(v) = S_{2^l}(v)$ by one of the $\tilde{R}_{2^{l+1}}^i$ ($i = 1, \dots, 12$).

If we restrict the summation to the sites in the union of the \bar{R}_q 's, we get that

$$\begin{aligned}
& \sum_{v \in S_{2^{K-3}}} (\bar{p}_v - p) \bar{\mathbb{P}}_t(v \rightsquigarrow_{4, \sigma_4} \partial S_{2^K}) \\
& \geq \sum_q \sum_{v \in \bar{R}_q} (\bar{p}_v - p) \bar{\mathbb{P}}_t(v \rightsquigarrow_{4, \sigma_4} \partial S_{2^K}) \\
& \geq C_1 \sum_q \sum_{v \in \bar{R}_q} (\bar{p}_v - p) \bar{\mathbb{P}}_t(v \rightsquigarrow_{4, \sigma_4} \partial \bar{R}'_q) \bar{\mathbb{P}}_t(\partial \bar{R}'_q \rightsquigarrow_{4, \sigma_4} \partial S_{2^K}) \\
& = C_1 \left(\sum_q \bar{\mathbb{P}}_t(\partial \bar{R}'_q \rightsquigarrow_{4, \sigma_4} \partial S_{2^K}) \right) S_j^{i, (4)}.
\end{aligned}$$

Hence, using Reimer's inequality and the a-priori bound for one arm,

$$\begin{aligned}
& \sum_{v \in S_{2^{K-3}}} (\bar{p}_v - p) \bar{\mathbb{P}}_t(v \rightsquigarrow_{4, \sigma_4} \partial S_{2^K}) \\
& \geq C_2 \left(\sum_q \bar{\mathbb{P}}_t(\partial \bar{R}'_q \rightsquigarrow_{5, \sigma_5} \partial S_{2^K}) \bar{\mathbb{P}}_t(\partial \bar{R}'_q \rightsquigarrow \partial S_{2^K})^{-1} \right) S_j^{i, (4)} \\
& \geq C_3 2^{\alpha'(K-j)} S_j^{i, (4)} \left(\sum_q \bar{\mathbb{P}}_t(\partial \bar{R}'_q \rightsquigarrow_{5, \sigma_5} \partial S_{2^K}) \right).
\end{aligned}$$

The same type of manipulation for 5 arms gives, introducing \bar{R}''_q the box of size 2^{j+2} centered on \bar{R}'_q ,

$$\begin{aligned}
& \sum_{v \in S_{2^{K-3}}} \bar{\mathbb{P}}_t(v \rightsquigarrow_{5, \sigma_5} \partial S_{2^K}) \leq \sum_q \sum_{v \in \bar{R}'_q} \bar{\mathbb{P}}_t(v \rightsquigarrow_{5, \sigma_5} \partial \bar{R}''_q) \bar{\mathbb{P}}_t(\partial \bar{R}''_q \rightsquigarrow_{5, \sigma_5} \partial S_{2^K}) \\
& \leq C_4 \left(\sum_q \bar{\mathbb{P}}_t(\partial \bar{R}''_q \rightsquigarrow_{5, \sigma_5} \partial S_{2^K}) \right),
\end{aligned}$$

since we know from Lemma 25 that $\sum_{v \in \bar{R}'_q} \bar{\mathbb{P}}_t(v \rightsquigarrow_{5, \sigma_5} \partial \bar{R}''_q) \asymp 1$. We also know that $\sum_{v \in S_{2^{K-3}}} \bar{\mathbb{P}}_t(v \rightsquigarrow_{5, \sigma_5} \partial S_{2^K}) \asymp 1$ (still by Lemma 25) and $\bar{\mathbb{P}}_t(\partial \bar{R}''_q \rightsquigarrow_{5, \sigma_5} \partial S_{2^K}) \asymp \bar{\mathbb{P}}_t(\partial \bar{R}'_q \rightsquigarrow_{5, \sigma_5}$

∂S_{2^k}), we thus have

$$\sum_q \bar{\mathbb{P}}_t(\partial \bar{R}'_q \rightsquigarrow_{5, \sigma_5} \partial S_{2^k}) \geq C_5 \quad (6.20)$$

for some $C_5 > 0$. This implies that

$$S_j^{i, (4)} \leq C_6 2^{-\alpha'(K-j)} \sum_{v \in S_{2^{K-3}}} (\bar{p}_v - p) \bar{\mathbb{P}}_t(v \rightsquigarrow_{4, \sigma_4} \partial S_{2^k}),$$

and finally, by integrating and using Eq.(6.19),

$$\int_0^1 \sum_{v \in \hat{R}_{2^j}^i} (\hat{p}_v - p) \hat{\mathbb{P}}_t(v \rightsquigarrow_{4, \sigma_4} \partial \hat{R}_{2^j}^i) dt \leq C_6 2^{-\alpha'(K-j)}.$$

The sum of Eq.(6.18) is thus less than

$$\sum_{j=k_0+3}^{K-4} 12C_6 2^{-\alpha'(K-j)} \leq C_7 \sum_{r=0}^{\infty} 2^{-\alpha' r} < \infty,$$

which completes the proof. \square

Remark 31. We will use this theorem in the next section to relate the so-called “characteristic functions” to the arm exponents at criticality. We will have use in fact only for the two cases $j = 1$ and $j = 4$, $\sigma = \sigma_4$: the general case (3rd case in the previous proof) will thus not be needed there. It is however of interest for other applications, for instance to say that for an interface in near-critical percolation, the dimension of the accessible perimeter is the same as at criticality: this requires the case $j = 3$, $\sigma = \sigma_3$.

6.3 Some complements

Theorem for more general annuli

We will sometimes need a version of Theorem 27 with non concentric rhombi. For instance, for any fixed $\eta > 0$,

$$\hat{\mathbb{P}}(\partial S_n(v) \rightsquigarrow \partial S_N) \asymp \mathbb{P}_{1/2}(\partial S_n \rightsquigarrow \partial S_N) \quad (6.21)$$

uniformly in $v \in S_{(1-\eta)N}$. It results from the remark on more general annuli (Eq.(4.20)) combined with Theorem 27 applied to $\hat{\mathbb{P}}^v$, the measure $\hat{\mathbb{P}}$ translated by v .

A complementary bound

Following the same lines as in the previous proof, we can get a bound in the other direction:

Proposition 32. *There exists some universal constant $\tilde{C} > 1$ such that for all $p > 1/2$,*

$$\mathbb{P}_p(0 \rightsquigarrow \partial S_{L(p)}) \geq \tilde{C} \mathbb{P}_{1/2}(0 \rightsquigarrow \partial S_{L(p)}). \quad (6.22)$$

In other words, the one-arm probability varies of a non-negligible amount, like the crossing probability: there is a macroscopic difference with the critical regime.

Proof. Take K such that $2^K \leq L(p) < 2^{K+1}$ and $(\hat{\mathbb{P}}_t)$ the linear interpolation between $\mathbb{P}_{1/2}$ and \mathbb{P}_p . By gluing arguments, for $A = \{0 \rightsquigarrow \partial S_{L(p)}\}$, for any $v \in S_{2^{K-4}, 2^{K-3}}$,

$$\begin{aligned} & \tilde{\mathbb{P}}_t(v \text{ is pivotal for } A) \\ & \geq C_1 \tilde{\mathbb{P}}_t(0 \rightsquigarrow \partial S_{2^{K-5}}) \tilde{\mathbb{P}}_t(\partial S_{2^{K-2}} \rightsquigarrow \partial S_{L(p)}) \tilde{\mathbb{P}}_t(v \rightsquigarrow_{4, \sigma_4} \partial S_{2^{K-5}}(v)) \\ & \geq C_2 \tilde{\mathbb{P}}_t(0 \rightsquigarrow \partial S_{2^K}) \tilde{\mathbb{P}}_t(v \rightsquigarrow_{4, \sigma_4} \partial S_{2^{K-5}}(v)), \end{aligned}$$

so that

$$\begin{aligned} \frac{d}{dt} \log [\tilde{\mathbb{P}}_t(A)] & \geq \sum_{v \in S_{2^{K-4}, 2^{K-3}}} (p - 1/2) \hat{\mathbb{P}}_t(v \rightsquigarrow_{4, \sigma_4} \partial S_{2^{K-5}}(v)) \\ & \geq C_3 (p - 1/2) L(p)^2 \hat{\mathbb{P}}_t(0 \rightsquigarrow_{4, \sigma_4} \partial S_{L(p)}), \end{aligned}$$

since each of the sites $v \in S_{2^{K-4}, 2^{K-3}}$ produces a contribution of order $\hat{\mathbb{P}}_t(0 \rightsquigarrow_{4, \sigma_4} \partial S_{L(p)})$. Proposition 34, proved later⁴, allows to conclude. \square

7 Consequences for the characteristic functions

7.1 Different characteristic lengths

Roughly speaking, a *characteristic length* is a quantity intended to measure a “typical” scale of the system. There may be several natural definitions of such a length, but we usually expect the different possible definitions to produce lengths that are of the same order of magnitude. For two-dimensional percolation, the three most common definitions are the following:

Finite-size scaling

The lengths L_ϵ that we have used throughout the paper, introduced in [15], are known as “finite-size scaling characteristic lengths”:

$$L_\epsilon(p) = \begin{cases} \min\{n \text{ s.t. } \mathbb{P}_p(\mathcal{C}_H([0, n] \times [0, n])) \leq \epsilon\} & \text{when } p < 1/2, \\ \min\{n \text{ s.t. } \mathbb{P}_p(\mathcal{C}_H^*([0, n] \times [0, n])) \leq \epsilon\} & \text{when } p > 1/2. \end{cases} \quad (7.1)$$

Mean radius of a finite cluster

The (quadratic) mean radius measures the “typical” size of a finite cluster. It can be defined by the formula

$$\xi(p) = \left[\frac{1}{\mathbb{E}_p[|C(0)|; |C(0)| < \infty]} \sum_x \|x\|_\infty^2 \mathbb{P}_p(0 \rightsquigarrow x, |C(0)| < \infty) \right]^{1/2}. \quad (7.2)$$

⁴This does not raise any problem since we have included this complementary bound only for the sake of completeness, and we will not use it later.

Connection probabilities

A third possible definition would be via the rate of decay of correlations. Take first $p < 1/2$ for example. For two sites x and y , we consider the connection probability between them

$$\tau_{x,y} := \mathbb{P}_p(x \rightsquigarrow y), \quad (7.3)$$

and then

$$\tau_n := \sup_{x \in \partial S_n} \tau_{0,x}, \quad (7.4)$$

the maximum connection probability between sites at distance n (using translation invariance). For any $n, m \geq 0$, we have

$$\tau_{n+m} \geq \tau_n \tau_m,$$

in other words $(-\log \tau_n)_{n \geq 0}$ is sub-additive, which implies the existence of a constant $\tilde{\xi}(p)$ such that

$$-\frac{\log \tau_n}{n} \rightarrow \frac{1}{\tilde{\xi}(p)} = \inf_m \left(-\frac{\log \tau_m}{m} \right) \quad (7.5)$$

when $n \rightarrow \infty$. Note the following a-priori bound:

$$\mathbb{P}_p(0 \rightsquigarrow x) \leq e^{-\|x\|_\infty / \tilde{\xi}(p)}. \quad (7.6)$$

For $p > 1/2$, we simply use the symmetry $p \leftrightarrow 1 - p$: we consider

$$\tau_n^* := \sup_{x \in \partial S_n} \mathbb{P}_p(0 \rightsquigarrow^* x) \quad (7.7)$$

and then $\tilde{\xi}(p)$ in the same way. We have in this case

$$\mathbb{P}_p(0 \rightsquigarrow^* x) \leq e^{-\|x\|_\infty / \tilde{\xi}(p)}. \quad (7.8)$$

Note that the symmetry $p \leftrightarrow 1 - p$ gives immediately

$$\tilde{\xi}(p) = \tilde{\xi}(1 - p).$$

Relation between the different lengths

As expected, these characteristic lengths turn out to be all of the same order of magnitude: we will prove in Section 7.3 that $L_\epsilon \asymp L_{\epsilon'}$ for any two $\epsilon, \epsilon' \in (0, 1/2)$, in Section 7.4 that $L \asymp \tilde{\xi}$, and in Section 7.5 that $L \asymp \xi$.

7.2 Main critical exponents

We focus here on three functions commonly used to describe the macroscopic behavior of percolation. We have already encountered some of them:

- (i) $\xi(p) = \left[\frac{1}{\mathbb{E}_p[|C(0)|; |C(0)| < \infty]} \sum_x \|x\|_\infty^2 \mathbb{P}_p(0 \rightsquigarrow x, |C(0)| < \infty) \right]^{1/2}$ the mean radius of a finite cluster.

(ii) $\theta(p) := \mathbb{P}_p(0 \rightsquigarrow \infty)$. This function can be viewed as the density of the infinite cluster C_∞ , in the following sense:

$$\frac{1}{|S_N|} |S_N \cap C_\infty| \xrightarrow{\text{a.s.}} \theta(p) \quad (7.9)$$

when $N \rightarrow \infty$.

(iii) $\chi(p) = \mathbb{E}_p[|C(0)|; |C(0)| < \infty]$ the average size of a finite cluster.

Theorem 33 (Critical exponents). *The following power-law estimates hold:*

(i) When $p \rightarrow 1/2$,

$$\xi(p) \asymp \bar{\xi}(p) \asymp L(p) \approx |p - 1/2|^{-4/3}. \quad (7.10)$$

(ii) When $p \rightarrow 1/2^+$,

$$\theta(p) \approx (p - 1/2)^{5/36}. \quad (7.11)$$

(iii) When $p \rightarrow 1/2$,

$$\chi(p) \approx |p - 1/2|^{-43/18}. \quad (7.12)$$

The corresponding exponents are usually denoted by (respectively) ν , β and γ . This theorem is proved in the next sub-sections by combining the arm exponents for critical percolation with the estimates established for near-critical percolation.

7.3 Critical exponent for L

We derive here⁵ the exponent for $L_\epsilon(p)$ by counting the sites which are pivotal for the existence of a crossing in a box of size $L_\epsilon(p)$. These pivotal sites are exactly those for which the 4-arm event $\bar{A}_{4,\sigma_4}^{\bar{I}}$ with alternating colors ($\sigma_4 = BWBW$) and sides ($\bar{I} =$ right, top, left and bottom sides):

Proposition 34 ([31; 47]). *For any fixed $\epsilon \in (0, 1/2)$, the following equivalence holds:*

$$|p - 1/2| (L_\epsilon(p))^2 \pi_4(L_\epsilon(p)) \asymp 1. \quad (7.13)$$

Recall now the value $\alpha_4 = 5/4$ of the 4-arm exponent, stated in Theorem 21. If we plug it into Eq.(7.13), we get the value of the characteristic length exponent: when $p \rightarrow 1/2$,

$$1 \approx |p - 1/2| (L_\epsilon(p))^2 (L_\epsilon(p))^{-5/4} = |p - 1/2| (L_\epsilon(p))^{3/4},$$

so that indeed

$$L_\epsilon(p) \approx |p - 1/2|^{-4/3}.$$

⁵In this sub-section and in the next one, we temporarily choose to stress that L depends on ϵ – in particular we study this dependence.

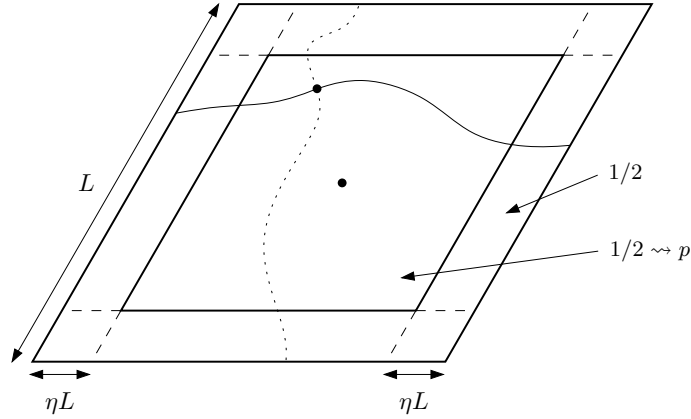

Figure 14: We restrict to the sites at distance at least ηL from the boundary of $[0, L]^2$: these sites produce contributions of the same order, since the 4 arms stay comparable in size.

Proof. For symmetry reasons, we can assume that $p > 1/2$. The proof goes as follows. We first apply Russo's formula to estimate the variation in probability of the event $\mathcal{C}_H([0, L_\epsilon(p)] \times [0, L_\epsilon(p)])$ between $1/2$ and p , which makes appear the events $\bar{A}_{4, \sigma_4}^{\bar{I}}$. By construction of $L_\epsilon(p)$, the variation of the crossing event is of order 1, and the sites that are “not too close to the boundary” (such that none of the 4 arms can become too small – see Figure 14) each produce a contribution of the same order by Theorem 27: proving that they all together produce a non-negligible variation in the crossing probabilities will thus imply the result. For that, we need the following lemma:

Lemma 35. *For any $\delta > 0$, there exists $\eta_0 > 0$ such that for all $p, \hat{\mathbb{P}}$ between \mathbb{P}_p and \mathbb{P}_{1-p} , we have: for any parallelogram $[0, n] \times [0, m]$ with sides $n, m \leq L(p)$ and aspect ratio less than 2 (ie such that $1/2 \leq n/m \leq 2$), for any $\eta \leq \eta_0$,*

$$\left| \hat{\mathbb{P}}(\mathcal{C}_H([0, n] \times [0, m])) - \hat{\mathbb{P}}(\mathcal{C}_H([0, (1 + \eta)n] \times [0, m])) \right| \leq \delta. \quad (7.14)$$

Proof of lemma. First, we clearly have

$$\hat{\mathbb{P}}(\mathcal{C}_H([0, n] \times [0, m])) \geq \hat{\mathbb{P}}(\mathcal{C}_H([0, (1 + \eta)n] \times [0, m])).$$

For the converse bound, we use the same idea as for Lemma 15, we apply RSW in concentric annuli (see Figure 15). By considering (parts of) annuli centered on the top right corner of $[0, n] \times [0, m]$, with radii between $\eta^{3/4}n$ and $\sqrt{\eta}n$, we see that the probability for a crossing to arrive at a distance less than $\eta^{3/4}n$ from this corner is at most $\delta/100$ for η_0 small enough. Assume this is not the case, condition on the lowest crossing and apply RSW in annuli between scales ηn and $\eta^{3/4}n$: if η_0 is sufficiently small, with probability at least $1 - \delta/100$, this crossing can be extended into a crossing of $[0, (1 + \eta)n] \times [0, m]$. \square

Let us return to the proof of the proposition. Take η_0 associated to $\delta = \epsilon/100$ by the lemma, and assume that instead of performing the change $1/2 \rightsquigarrow p$ in the whole box $[0, L_\epsilon(p)]^2$, we make it

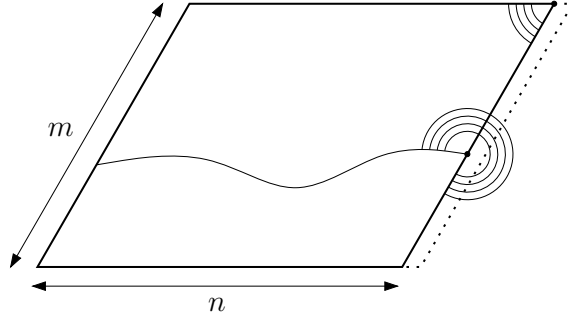

Figure 15: We extend a crossing of $[0, n] \times [0, m]$ into a crossing of $[0, (1+\eta)n] \times [0, m]$ by applying RSW in concentric annuli.

only for the sites in the sub-box $[\eta L_\epsilon(p), (1-\eta)L_\epsilon(p)]^2$, for $\eta = \eta_0/4$. It amounts to consider the measure $\hat{\mathbb{P}}^{(\eta)}$ with parameters

$$\hat{p}_v^{(\eta)} = \begin{cases} p & \text{if } v \in [\eta L_\epsilon(p), (1-\eta)L_\epsilon(p)]^2, \\ 1/2 & \text{otherwise.} \end{cases} \quad (7.15)$$

We are going to prove that $\hat{\mathbb{P}}^{(\eta)}(\mathcal{C}_H([0, L_\epsilon(p)]^2))$ and $\mathbb{P}_p(\mathcal{C}_H([0, L_\epsilon(p)]^2))$ are very close by showing that they are both very close to $\mathbb{P}_p(\mathcal{C}_H([\eta L_\epsilon(p), (1-\eta)L_\epsilon(p)]^2)) = \hat{\mathbb{P}}^{(\eta)}(\mathcal{C}_H([\eta L_\epsilon(p), (1-\eta)L_\epsilon(p)]^2))$. Indeed, for any $\tilde{\mathbb{P}} \in \{\hat{\mathbb{P}}^{(\eta)}, \mathbb{P}_p\}$, we have by the lemma

$$\begin{aligned} \tilde{\mathbb{P}}(\mathcal{C}_H([0, L_\epsilon(p)]^2)) &\leq \tilde{\mathbb{P}}(\mathcal{C}_H([\eta L_\epsilon(p), (1-\eta)L_\epsilon(p)] \times [0, L_\epsilon(p)])) \\ &= 1 - \tilde{\mathbb{P}}(\mathcal{C}_V^*([\eta L_\epsilon(p), (1-\eta)L_\epsilon(p)] \times [0, L_\epsilon(p)])) \\ &\leq 1 - (\tilde{\mathbb{P}}(\mathcal{C}_V^*([\eta L_\epsilon(p), (1-\eta)L_\epsilon(p)]^2)) - 2\delta) \\ &= \tilde{\mathbb{P}}(\mathcal{C}_H([\eta L_\epsilon(p), (1-\eta)L_\epsilon(p)]^2)) + 2\delta, \end{aligned}$$

and in the other way,

$$\begin{aligned} \tilde{\mathbb{P}}(\mathcal{C}_H([0, L_\epsilon(p)]^2)) &\geq \tilde{\mathbb{P}}(\mathcal{C}_H([\eta L_\epsilon(p), (1-\eta)L_\epsilon(p)] \times [0, L_\epsilon(p)])) - 2\delta \\ &= 1 - \tilde{\mathbb{P}}(\mathcal{C}_V^*([\eta L_\epsilon(p), (1-\eta)L_\epsilon(p)] \times [0, L_\epsilon(p)])) - 2\delta \\ &\geq 1 - \tilde{\mathbb{P}}(\mathcal{C}_V^*([\eta L_\epsilon(p), (1-\eta)L_\epsilon(p)]^2)) - 2\delta \\ &= \tilde{\mathbb{P}}(\mathcal{C}_H([\eta L_\epsilon(p), (1-\eta)L_\epsilon(p)]^2)) - 2\delta. \end{aligned}$$

The claim follows readily, in particular

$$\hat{\mathbb{P}}^{(\eta)}(\mathcal{C}_H([0, L_\epsilon(p)]^2)) \geq \mathbb{P}_p(\mathcal{C}_H([0, L_\epsilon(p)]^2)) - 4\delta, \quad (7.16)$$

which is at least $(1/2 + \epsilon) - 4\delta \geq 1/2 + \epsilon/2$ by the very definition of $L_\epsilon(p)$. It shows as desired that the sites in $[\eta L_\epsilon(p), (1-\eta)L_\epsilon(p)]^2$ produce all together a non-negligible contribution.

Now, Russo's formula applied to the interpolating measures $(\hat{\mathbb{P}}_t^{(\eta)})_{t \in [0,1]}$ (with parameters $\hat{p}_v^{(\eta)}(t) =$

$t \times \hat{p}_v^{(\eta)} + (1-t) \times 1/2$ and the event $\mathcal{C}_H([0, L_\epsilon(p)]^2)$ gives

$$\begin{aligned} \int_0^1 \sum_{v \in [\eta L_\epsilon(p), (1-\eta)L_\epsilon(p)]^2} (p-1/2) \hat{\mathbb{P}}_t^{(\eta)}(v \rightsquigarrow_{4, \sigma_4}^I \partial[0, L_\epsilon(p)]^2) dt \\ = \hat{\mathbb{P}}^{(\eta)}(\mathcal{C}_H([0, L_\epsilon(p)]^2)) - \mathbb{P}_{1/2}(\mathcal{C}_H([0, L_\epsilon(p)]^2)), \end{aligned}$$

and this quantity is at least $\epsilon/2$, and thus of order 1.

Finally, it is not hard to see that once η fixed, we have (uniformly in p , $\hat{\mathbb{P}}$ between \mathbb{P}_p and \mathbb{P}_{1-p} , and $v \in [\eta L_\epsilon(p), (1-\eta)L_\epsilon(p)]^2$)

$$\begin{aligned} \hat{\mathbb{P}}(v \rightsquigarrow_{4, \sigma_4}^I \partial[0, L_\epsilon(p)]^2) &\asymp \hat{\mathbb{P}}(v \rightsquigarrow_{4, \sigma_4} \partial S_{\frac{1}{2}L_\epsilon(p)}(v)) \\ &\asymp \mathbb{P}_{1/2}(0 \rightsquigarrow_{4, \sigma_4} \partial S_{\frac{1}{2}L_\epsilon(p)}) \\ &\asymp \mathbb{P}_{1/2}(0 \rightsquigarrow_{4, \sigma_4} \partial S_{L_\epsilon(p)}), \end{aligned}$$

which yields the desired conclusion. \square

Remark 36. Note that the intermediate lemma was required for the lower bound only, the upper bound can be obtained directly from Russo's formula. To get the lower bound, we could also have proved that for $n \leq L(p)$,

$$\sum_{x \in S_n} \hat{\mathbb{P}}(x \rightsquigarrow_{4, \sigma_4} \partial S_n) \asymp n^2 \pi_4(n). \quad (7.17)$$

Basically, it comes from the fact that when we get closer to ∂S_N , one of the arms may be shorter, but the remaining arms also have less space – and the 3-arm exponent in the half-plane appears.

All the results we have seen so far hold for any fixed value of ϵ in $(0, 1/2)$, in particular Proposition 34. Combining it with the estimate for 4 arms, we get an important corollary, that the behavior of L_ϵ does not depend on the value of ϵ .

Corollary 37. For any $\epsilon, \epsilon' \in (0, 1/2)$,

$$L_\epsilon(p) \asymp L_{\epsilon'}(p). \quad (7.18)$$

Proof. To fix ideas, assume that $\epsilon \leq \epsilon'$, so that $L_\epsilon(p) \geq L_{\epsilon'}(p)$, and we need to prove that $L_\epsilon(p) \leq CL_{\epsilon'}(p)$ for some constant C . We know that

$$|p-1/2|(L_\epsilon(p))^2 \pi_4(L_\epsilon(p)) \asymp 1 \asymp |p-1/2|(L_{\epsilon'}(p))^2 \pi_4(L_{\epsilon'}(p)),$$

hence for some constant C_1 ,

$$\frac{(L_\epsilon(p))^2 \pi_4(L_\epsilon(p))}{(L_{\epsilon'}(p))^2 \pi_4(L_{\epsilon'}(p))} \leq C_1.$$

This yields

$$\left(\frac{L_\epsilon(p)}{L_{\epsilon'}(p)} \right)^2 \leq C_1 \frac{\pi_4(L_{\epsilon'}(p))}{\pi_4(L_\epsilon(p))} \leq C_2 (\pi_4(L_{\epsilon'}(p), L_\epsilon(p)))^{-1}$$

by quasi-multiplicativity. Now we use the a-priori bound for 4 arms given by the 5-arm exponent:

$$\pi_4(L_{\epsilon'}(p), L_\epsilon(p)) \geq C_3 \left(\frac{L_{\epsilon'}(p)}{L_\epsilon(p)} \right)^{-\alpha'} \pi_5(L_{\epsilon'}(p), L_\epsilon(p)) \geq C_4 \left(\frac{L_{\epsilon'}(p)}{L_\epsilon(p)} \right)^{2-\alpha'}.$$

Together with the previous equation, it implies the result:

$$L_\epsilon(p) \leq (C_5)^{1/\alpha'} L_{\epsilon'}(p).$$

□

Remark 38. *In the other direction, a RSW construction shows that we can increase L_ϵ by any constant factor by choosing ϵ small enough.*

7.4 Uniform exponential decay, critical exponent for θ

Up to now, our reasonings (separation of arms, arm events near criticality, critical exponent for L) were based on RSW considerations on scales $n \leq L(p)$, so that critical and near-critical percolation could be handled simultaneously. In the other direction, the definition of $L(p)$ also implies that when $n > L(p)$, the picture starts to look like super/sub-critical percolation, supporting the choice of $L(p)$ as the characteristic scale of the model.

More precisely, we prove a property of exponential decay uniform in p . This property will then be used to link L with the other characteristic functions, and we will derive the following expressions of θ , χ and ξ as functions of L :

- (i) $\theta(p) \asymp \pi_1(L(p))$,
- (ii) $\chi(p) \asymp L(p)^2 \pi_1^2(L(p))$,
- (iii) $\xi(p) \asymp L(p)$.

The critical exponents for these three functions will follow readily, since we already know the exponent for L .

Uniform exponential decay

The following lemma shows that correlations decay exponentially fast with respect to $L(p)$. This allows to control the speed for p varying:

Lemma 39. *For any $\epsilon \in (0, 1/2)$, there exist constants $C_i = C_i(\epsilon) > 0$ such that for all $p < 1/2$, all n ,*

$$\mathbb{P}_p(\mathcal{C}_H([0, n] \times [0, n])) \leq C_1 e^{-C_2 n/L_\epsilon(p)}. \quad (7.19)$$

Proof. We use a block argument: for each integer n ,

$$\mathbb{P}_p(\mathcal{C}_H([0, 2n] \times [0, 4n])) \leq C' [\mathbb{P}_p(\mathcal{C}_H([0, n] \times [0, 2n]))]^2, \quad (7.20)$$

with $C' = 10^2$ some universal constant.

It suffices for that (see Figure 16) to divide the parallelogram $[0, 2n] \times [0, 4n]$ into 4 horizontal sub-parallelograms $[0, 2n] \times [in, (i+1)n]$ ($i = 0, \dots, 3$) and 6 vertical ones $[in, (i+1)n] \times [jn, (j+2)n]$ ($i = 0, 1, j = 0, 1, 2$). Indeed, consider a horizontal crossing of the big parallelogram: by considering its pieces in the two regions $0 < x < n$ and $n < x < 2n$, we can extract from it two sub-paths, each

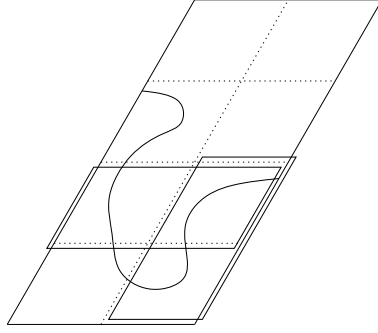

Figure 16: Two of the small sub-parallelograms are crossed in the “easy” way.

crossing one of the 10 sub-parallelograms “in the easy way”. They are disjoint by construction, so the claim follows by using the BK inequality.

We then obtain by iterating:

$$C' \mathbb{P}_p(\mathcal{C}_H([0, 2^k L_\epsilon(p)] \times [0, 2^{k+1} L_\epsilon(p)])) \leq (C' \tilde{\epsilon})^{2^k} \quad (7.21)$$

with $\tilde{\epsilon} \geq \mathbb{P}_p(\mathcal{C}_H([0, L_\epsilon(p)] \times [0, 2L_\epsilon(p)]))$.

Recall that by definition, $\mathbb{P}_p(\mathcal{C}_H([0, L_\epsilon(p)] \times [0, L_\epsilon(p)])) \leq \epsilon_0$ if $\epsilon \leq \epsilon_0$. The RSW theory thus implies (Theorem 2) that for all fixed $\tilde{\epsilon} > 0$, we can take ϵ_0 sufficiently small to get automatically (and independently of p) that

$$\mathbb{P}_p(\mathcal{C}_H([0, L_\epsilon(p)] \times [0, 2L_\epsilon(p)])) \leq \tilde{\epsilon}. \quad (7.22)$$

We now choose $\tilde{\epsilon} = 1/(e^2 C')$. For each integer $n \geq L_\epsilon(p)$, we can define $k = k(n)$ such that $2^k \leq n/L_\epsilon(p) < 2^{k+1}$, and then,

$$\begin{aligned} \mathbb{P}_p(\mathcal{C}_H([0, n] \times [0, n])) &\leq \mathbb{P}_p(\mathcal{C}_H([0, 2^k L_\epsilon(p)] \times [0, 2^{k+1} L_\epsilon(p)])) \\ &\leq e^{-2^{k+1}} \\ &\leq e \times e^{-n/L_\epsilon(p)}, \end{aligned}$$

which is also valid for $n < L_\epsilon(p)$, thanks to the extra factor e .

Hence, we have proved the property for any ϵ below some fixed value ϵ_0 (given by RSW). The result for any $\epsilon \in (0, 1/2)$ follows readily by using the equivalence of lengths for different values of ϵ (Corollary 37). \square

We would like to stress the fact that in the proof, we have not used any of the previous results until the last step. This exponential decay property could thus have been derived much earlier – but only for values of ϵ small enough. It would for instance provide a more direct way to prove that

$$L_\epsilon(p) \asymp L_{\epsilon'}(p),$$

but still only for ϵ, ϵ' less than some fixed value.

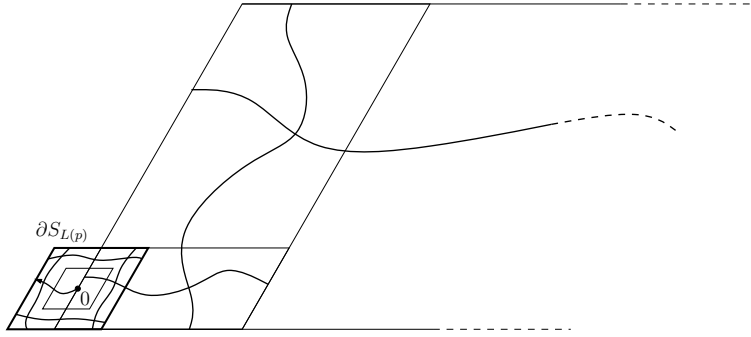

Figure 17: We consider overlapping parallelograms, with size doubling at each step.

Remark 40. It will sometimes reveal useful to know this property for crossings of longer parallelograms “in the easy way”: we also have for any $k \geq 1$,

$$\mathbb{P}_p(\mathcal{C}_H([0, n] \times [0, kn])) \leq C_1^{(k)} e^{-C_2^{(k)} n/L_\epsilon(p)} \quad (7.23)$$

for some constants $C_i^{(k)}$ (depending on k and ϵ). This can be proved by combining the previous lemma with the fact that in Theorem 2, we can take f_k satisfying $f_k(1 - \epsilon) = 1 - C_k \epsilon^{\alpha_k} + o(\epsilon^{\alpha_k})$ for some $C_k, \alpha_k > 0$.

Consequence for θ

When $p > 1/2$, we now show that at a distance $L(p)$ from the origin, we are already “not too far from infinity”: once we have reached this distance, there is a positive probability (bounded away from 0 uniformly in p) to reach infinity.

Corollary 41. We have

$$\theta(p) = \mathbb{P}_p(0 \rightsquigarrow \infty) \asymp \mathbb{P}_p(0 \rightsquigarrow \partial S_{L(p)}) \quad (7.24)$$

uniformly in $p > 1/2$.

Proof. It suffices to consider overlapping parallelograms as in Figure 17, each parallelogram twice larger than the previous one, so that the k^{th} of them has a probability at least $1 - C_1 e^{-C_2 2^k}$ to present a crossing in the “hard” direction (thanks to the previous remark). Since $\prod_k (1 - C_1 e^{-C_2 2^k}) > 0$, we are done. \square

Now, combining Eq.(7.24) with Theorem 27 gives, for $p > 1/2$,

$$\theta(p) \asymp \mathbb{P}_p(0 \rightsquigarrow \partial S_{L(p)}) \asymp \mathbb{P}_{1/2}(0 \rightsquigarrow \partial S_{L(p)}) = \pi_1(L(p)). \quad (7.25)$$

Using the 1-arm exponent $\alpha_1 = 5/48$ stated in Theorem 21, we get

$$\theta(p) \approx (L(p))^{-5/48} \quad (7.26)$$

as $p \rightarrow 1/2^+$. Together with the critical exponent for L derived previously, this provides the critical exponent for θ :

$$\theta(p) \approx ((p - 1/2)^{-4/3})^{-5/48} \approx (p - 1/2)^{5/36}. \quad (7.27)$$

Equivalence of L and $\tilde{\xi}$

To fix ideas, we assume in this sub-section that $p < 1/2$. Performing a RSW-type construction as in Figure 3 yields

$$\mathbb{P}_p(\mathcal{C}_H([0, kL(p)] \times [0, L(p)])) \geq \delta_2^{k-1} \delta_1^{k-2} = C_1 e^{-C_2 kL(p)/L(p)}, \quad (7.28)$$

so that $L(p)$ measures *exactly* the speed of decaying. Once knowing this, it is easy to compare L and $\tilde{\xi}$.

Corollary 42. *We have*

$$\tilde{\xi}(p) \asymp L(p). \quad (7.29)$$

Proof. We exploit the previous remark: on one hand L measures the speed of decaying for crossings of rhombi, and on the other hand $\tilde{\xi}$ was defined to give the optimal bound for point-to-point connections.

More precisely, consider any $x \in \partial S_n$. If for instance x is on the right side of ∂S_n , then $0 \rightsquigarrow x$ implies that $\mathcal{C}_H([0, n] \times [-n, n])$ occurs, so that

$$\begin{aligned} \tau_{0,x} = \mathbb{P}_p(0 \rightsquigarrow x) &\leq \mathbb{P}_p(\mathcal{C}_H([0, n] \times [0, 2n])) \\ &\leq C_1^{(2)} e^{-C_2^{(2)} n/L(p)}. \end{aligned}$$

By definition of τ_n (Eq.(7.4)), we thus have $\tau_n \leq C_1^{(2)} e^{-C_2^{(2)} n/L(p)}$, which gives $\tau_{kL(p)} \leq C_1^{(2)} e^{-C_2^{(2)} k}$ and

$$-\frac{\log \tau_{kL(p)}}{kL(p)} \geq -\frac{1}{kL(p)} (\log C_1^{(2)} - C_2^{(2)} k) \xrightarrow{k \rightarrow \infty} \frac{C_2^{(2)}}{L(p)}.$$

Hence,

$$\frac{1}{\tilde{\xi}(p)} \geq \frac{C_2^{(2)}}{L(p)}$$

and finally $\tilde{\xi}(p) \leq CL(p)$.

Conversely, we know that $\mathbb{P}_p(\mathcal{C}_H([0, kL(p)] \times [0, kL(p)])) \geq \tilde{C}_1 e^{-\tilde{C}_2 k}$ for some $\tilde{C}_i > 0$ (Eq.(7.28)). Consequently,

$$\tau_{kL(p)} \geq \frac{1}{(kL(p) + 1)^2} \mathbb{P}_p(\mathcal{C}_H([0, kL(p)] \times [0, kL(p)])) \geq \frac{1}{(kL(p))^2} \tilde{C}_1 e^{-\tilde{C}_2 k},$$

which implies

$$-\frac{\log \tau_{kL(p)}}{kL(p)} \leq -\frac{1}{kL(p)} (\log \tilde{C}_1 - 2 \log(kL(p)) - \tilde{C}_2 k) \xrightarrow{k \rightarrow \infty} \frac{\tilde{C}_2}{L(p)},$$

whence the conclusion: $\tilde{\xi}(p) \geq C'L(p)$. □

7.5 Further estimates, critical exponents for χ and ξ

Estimates from critical percolation

We start by stating some estimates that we will need. These estimates were originally derived for critical percolation (see e.g. [28; 29]), but for exactly the same reasons they also hold for near-critical percolation on scales $n \leq L(p)$:

Lemma 43. *Uniformly in p , $\hat{\mathbb{P}}$ between \mathbb{P}_p and \mathbb{P}_{1-p} and $n \leq L(p)$, we have*

1. $\hat{\mathbb{E}}[|x \in S_n : x \rightsquigarrow \partial S_n|] \asymp n^2 \pi_1(n)$.

2. For any $t \geq 0$,

$$\sum_{x \in S_n} \|x\|_\infty^t \hat{\mathbb{P}}(0 \rightsquigarrow x) \asymp \sum_{x \in S_n} \|x\|_\infty^t \hat{\mathbb{P}}(0 \overset{S_n}{\rightsquigarrow} x) \asymp n^{t+2} \pi_1^2(n).$$

Note that item 2. implies in particular for $t = 0$ that

$$\hat{\mathbb{E}}[|x \in S_n : x \rightsquigarrow 0|] \asymp \hat{\mathbb{E}}[|x \in S_n : x \overset{S_n}{\rightsquigarrow} 0|] \asymp n^2 \pi_1^2(n).$$

Proof. We will have use for the fact that we can take $\alpha_1 = 1/2$ for $j = 1$ in Eq.(5.6) (actually any $\alpha < 1$ would be enough for our purpose): for any integers $n < N$,

$$\pi_1(n, N) \geq C(n/N)^{1/2}. \quad (7.30)$$

This can be proved like (3.15) of [5]: just use blocks of size n instead of individual sites to obtain that $\frac{N}{n} \pi_1^2(n, N)$ is bounded below by a constant.

Proof of item 1. We will use that

$$\hat{\mathbb{E}}[|x \in S_n : x \rightsquigarrow \partial S_n|] = \sum_{x \in S_n} \hat{\mathbb{P}}(x \rightsquigarrow \partial S_n). \quad (7.31)$$

For the lower bound, it suffices to note that for any $x \in S_n$,

$$\hat{\mathbb{P}}(x \rightsquigarrow \partial S_n) \geq \hat{\mathbb{P}}(x \rightsquigarrow \partial S_{2n}(x)) = \hat{\mathbb{P}}^x(0 \rightsquigarrow \partial S_{2n}) \quad (7.32)$$

(where $\hat{\mathbb{P}}^x$ is the measure $\hat{\mathbb{P}}$ translated by x), and that

$$\hat{\mathbb{P}}^x(0 \rightsquigarrow \partial S_{2n}) \geq C_1 \hat{\mathbb{P}}^x(0 \rightsquigarrow \partial S_n) \geq C_2 \pi_1(n) \quad (7.33)$$

by extendability and Theorem 27 for one arm.

For the upper bound, we sum over concentric rhombi around 0:

$$\begin{aligned} \sum_{x \in S_n} \hat{\mathbb{P}}(x \rightsquigarrow \partial S_n) &\leq \sum_{x \in S_n} \hat{\mathbb{P}}(x \rightsquigarrow \partial S_{d(x, \partial S_n)}(x)) \\ &= \sum_{x \in S_n} \hat{\mathbb{P}}^x(0 \rightsquigarrow \partial S_{d(x, \partial S_n)}) \\ &\leq C_1 n + \sum_{j=1}^n C_1 n \times C_2 \mathbb{P}_{1/2}(0 \rightsquigarrow \partial S_j) \end{aligned}$$

using that there are at most $C_1 n$ sites at distance j from ∂S_n , and Theorem 27. This last sum is at most

$$\begin{aligned} C_3 n \sum_{j=1}^n \pi_1(j) &\leq C_3 n \pi_1(n) \sum_{j=1}^n \frac{\pi_1(j)}{\pi_1(n)} \\ &\leq C_4 n \pi_1(n) \sum_{j=1}^n \pi_1(j, n)^{-1} \end{aligned}$$

by quasi-multiplicativity. Now Eq.(7.30) says that $\pi_1(j, n) \geq C(j/n)^{1/2}$, so that

$$\sum_{j=1}^n \pi_1(j, n)^{-1} \leq \sum_{j=1}^n (j/n)^{-1/2} = n^{1/2} \sum_{j=1}^n j^{-1/2} \leq C_5 n,$$

which gives the desired upper bound.

Proof of item 2.

Since

$$\sum_{x \in S_n} \|x\|_\infty^t \hat{\mathbb{P}}(0 \overset{S_n}{\rightsquigarrow} x) \leq \sum_{x \in S_n} \|x\|_\infty^t \hat{\mathbb{P}}(0 \rightsquigarrow x),$$

it suffices to prove the desired lower bound for the left-hand side, and the upper bound for the right-hand side.

Consider the lower bound first. We note (see Figure 18) that if 0 is connected to ∂S_n and if there exists a black circuit in $S_{2n/3, n}$ (which occurs with probability at least δ_6^4 by RSW), then any $x \in S_{n/3, 2n/3}$ connected to $\partial S_{2n}(x)$ will be connected to 0 in S_n . Using the FKG inequality, we thus get for such an x :

$$\hat{\mathbb{P}}(0 \overset{S_n}{\rightsquigarrow} x) \geq \delta_6^4 \hat{\mathbb{P}}(0 \rightsquigarrow \partial S_n) \hat{\mathbb{P}}(x \rightsquigarrow \partial S_{2n}(x))$$

which is at least (still using extendability and Theorem 27) $C_1 \pi_1^2(n)$. Consequently,

$$\begin{aligned} \sum_{x \in S_n} \|x\|_\infty^t \hat{\mathbb{P}}(0 \overset{S_n}{\rightsquigarrow} x) &\geq \sum_{x \in S_{n/3, 2n/3}} \|x\|_\infty^t C_1 \pi_1^2(n) \\ &\geq C_2 n^2 (n/3)^t \pi_1^2(n). \end{aligned}$$

Let us turn to the upper bound. We take a logarithmic division of S_n : define $k = k(n)$ so that $2^k < n \leq 2^{k+1}$, we have

$$\sum_{x \in S_n} \|x\|_\infty^t \hat{\mathbb{P}}(0 \rightsquigarrow x) \leq C_1 + \sum_{j=3}^{k+1} \sum_{x \in S_{2^{j-1}, 2^j}} \|x\|_\infty^t \hat{\mathbb{P}}(0 \rightsquigarrow x). \quad (7.34)$$

Now for $x \in S_{2^{j-1}, 2^j}$, take the two boxes $S_{2^{j-2}}(0)$ and $S_{2^{j-2}}(x)$: since they are disjoint,

$$\hat{\mathbb{P}}(0 \rightsquigarrow x) \leq \hat{\mathbb{P}}(0 \rightsquigarrow S_{2^{j-2}}(0)) \hat{\mathbb{P}}(x \rightsquigarrow S_{2^{j-2}}(x)), \quad (7.35)$$

which is at most $C_2 \pi_1^2(2^{j-1})$ using the same arguments as before. Our sum is thus less than (since $|S_{2^{j-1}, 2^j}| \leq C_3 2^{2j}$)

$$\sum_{j=3}^{k+1} C_3 2^{2j} \times (2^j)^t \times (C_2 \pi_1^2(2^{j-1})) \leq C_4 2^{(2+t)k} \pi_1^2(2^k) \times \left[\sum_{j=3}^{k+1} 2^{(2+t)(j-k)} \frac{\pi_1^2(2^{j-1})}{\pi_1^2(2^k)} \right]. \quad (7.36)$$

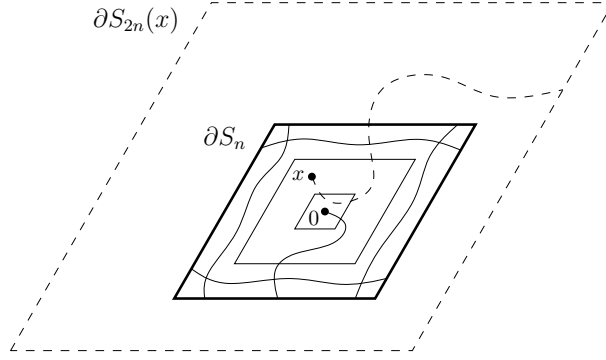

Figure 18: With this construction, any site x in $S_{n/3, 2n/3}$ connected to a site at distance $2n$ is also connected to 0 in S_n .

Now, $2^{(2+t)k} \pi_1^2(2^k) \leq C_5 n^{2+t} \pi_1^2(n)$, and this yields the desired result, using as previously $\frac{\pi_1(2^{j-1})}{\pi_1(2^k)} \leq C_6 \pi_1(2^{j-1}, 2^k)^{-1} \leq C_7 2^{-(j-k)/2}$:

$$\begin{aligned} \sum_{j=3}^{k+1} 2^{(2+t)(j-k)} \frac{\pi_1^2(2^{j-1})}{\pi_1^2(2^k)} &\leq C_7 \sum_{j=3}^{k+1} 2^{(2+t)(j-k)} 2^{-(j-k)} \\ &\leq C_8 \sum_{l=-1}^{k-3} 2^{-(1+t)l}, \end{aligned}$$

and this sum is bounded by $\sum_{l=-1}^{\infty} 2^{-(1+t)l} < \infty$. □

Main estimate

The following lemma will allow us to link directly χ and ξ with L . Roughly speaking, it relies on the fact that the sites at a distance much larger than $L(p)$ from the origin have a negligible contribution, due to the exponential decay property, so that the sites in $S_{L(p)}$ produce a positive fraction of the total sum:

Lemma 44. *For any $t \geq 0$, we have*

$$\sum_x \|x\|_{\infty}^t \mathbb{P}_p(0 \rightsquigarrow x, |C(0)| < \infty) \asymp L(p)^{t+2} \pi_1^2(L(p)) \quad (7.37)$$

uniformly in p .

Proof. Lower bound. The lower bound is a direct consequence of item 2. above: indeed,

$$\begin{aligned} \sum_x \|x\|_{\infty}^t \mathbb{P}_p(0 \rightsquigarrow x, |C(0)| < \infty) &\geq \mathbb{P}_p(\exists \text{ white circuit in } S_{L, 2L}) \sum_{x \in S_L} \|x\|_{\infty}^t \mathbb{P}_p(0 \overset{S_L}{\rightsquigarrow} x) \\ &\geq \delta_4^4 \sum_{x \in S_L} \|x\|_{\infty}^t \mathbb{P}_p(0 \overset{S_L}{\rightsquigarrow} x) \end{aligned}$$

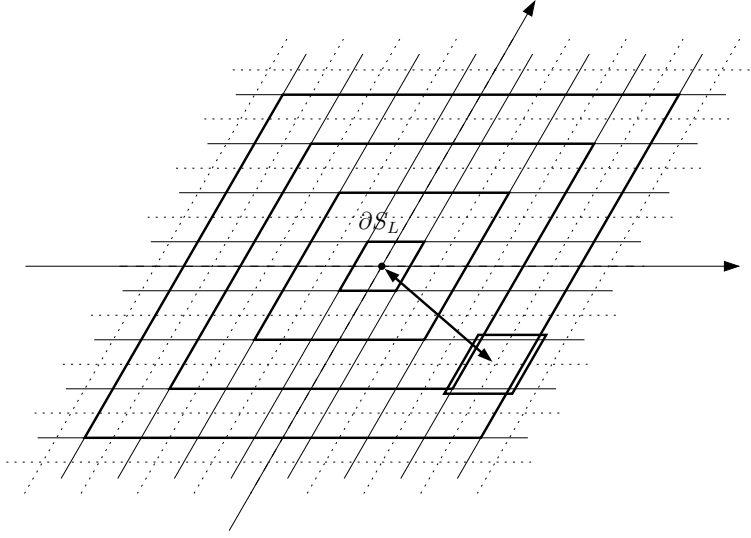

Figure 19: For the upper bound, we cover the plane with rhombi of size $2L$ and sum their different contributions.

by RSW, and item 2. gives

$$\sum_{x \in S_L} \|x\|_{\infty}^t \mathbb{P}_p(0 \overset{S_L}{\rightsquigarrow} x) \geq CL^{t+2} \pi_1^2(L).$$

Upper bound. To get the upper bound, we cover the plane by translating S_L : we consider the family of rhombi $S_L(2n_1L, 2n_2L)$, for any two integers n_1 and n_2 (see Figure 19). By isolating the contribution of S_L , we get:

$$\begin{aligned} & \sum_x \|x\|_{\infty}^t \mathbb{P}_p(0 \rightsquigarrow x, |C(0)| < \infty) \\ & \leq \sum_{x \in S_L} \|x\|_{\infty}^t \mathbb{P}_p(0 \rightsquigarrow x, |C(0)| < \infty) \\ & \quad + \sum_{(n_1, n_2) \neq (0,0)} \sum_{x \in S_L(2n_1L, 2n_2L)} \|x\|_{\infty}^t \mathbb{P}_p(0 \rightsquigarrow x, |C(0)| < \infty). \end{aligned}$$

Using item 2. above, we see that the rhombus S_L gives a contribution

$$\sum_{x \in S_L} \|x\|_{\infty}^t \mathbb{P}_p(0 \rightsquigarrow x, |C(0)| < \infty) \leq CL^{t+2} \pi_1^2(L),$$

which is of the right order of magnitude.

We now prove that each small rhombus outside of S_L at a distance kL gives a contribution of order $\pi_1(L) \times L^t \times \mathbb{E}_p[|x \in S_L : x \rightsquigarrow \partial S_L|] \asymp L^{t+2} \pi_1^2(L)$ (using item 1.), multiplied by some quantity which decays exponentially fast in k and will thus produce a series of finite sum. More precisely, if we regroup the rhombi into concentric annuli around S_L , we get that the previous summation is at

most

$$\begin{aligned}
& \sum_{k=1}^{\infty} \sum_{\substack{(n_1, n_2) \\ \|(n_1, n_2)\|_{\infty} = k}} \sum_{x \in S_L(2n_1L, 2n_2L)} \|x\|_{\infty}^t \mathbb{P}_p(0 \rightsquigarrow x, |C(0)| < \infty) \\
& \leq \sum_{k=1}^{\infty} \sum_{\substack{(n_1, n_2) \\ \|(n_1, n_2)\|_{\infty} = k}} \sum_{x \in S_L(2n_1L, 2n_2L)} [(2k+1)L]^t \mathbb{P}_p(0 \rightsquigarrow x, |C(0)| < \infty) \\
& \leq \sum_{k=1}^{\infty} \sum_{\substack{(n_1, n_2) \\ \|(n_1, n_2)\|_{\infty} = k}} C' k^t L^t \mathbb{E}_p[|C(0) \cap S_L(2n_1L, 2n_2L)|; |C(0)| < \infty].
\end{aligned}$$

Now, we have to distinguish between the sub-critical and the super-critical cases: we are going to prove that in both cases,

$$\mathbb{E}_p[|C(0) \cap S_L(2n_1L, 2n_2L)|; |C(0)| < \infty] \leq C_1 L^2 \pi_1^2(L) e^{-C_2 k} \quad (7.38)$$

for some constants $C_1, C_2 > 0$. When $p < 1/2$, we will use that

$$\mathbb{P}_p(\partial S_L \rightsquigarrow \partial S_{kL}) \leq C_3 e^{-C_4 k}, \quad (7.39)$$

which is a direct consequence of the exponential decay property Eq.(7.23) for “longer” parallelograms. When $p > 1/2$, we have an analog result, which can be deduced from the sub-critical case just as in the discrete case (replace sites by translates of S_L):

$$\begin{aligned}
& \mathbb{P}_p(\partial S_L \rightsquigarrow \partial S_{kL}, |C(0)| < \infty) \\
& \leq \mathbb{P}_p(\exists \text{ white circuit surrounding a site on } \partial S_L \text{ and a site on } \partial S_{kL}) \\
& \leq C_5 e^{-C_6 k}.
\end{aligned}$$

Assume first that $p < 1/2$. By independence, we have ($\|(n_1, n_2)\|_{\infty} = k$)

$$\begin{aligned}
& \mathbb{E}_p[|C(0) \cap S_L(2n_1L, 2n_2L)|; |C(0)| < \infty] \\
& \leq \mathbb{P}_p(0 \rightsquigarrow \partial S_L) \times \mathbb{E}_p[|x \in S_L(2n_1L, 2n_2L) : x \rightsquigarrow \partial S_L(2n_1L, 2n_2L)|] \\
& \quad \times \mathbb{P}_p(\partial S_L \rightsquigarrow \partial S_{(2k-1)L}) \\
& \leq \pi_1(L) \times (C'' L^2 \pi_1(L)) \times C'_3 e^{-C'_4 k}.
\end{aligned}$$

If $p > 1/2$, we write similarly (here we use FKG to separate the existence of a white circuit (decreasing) from the other terms (increasing), and then independence of the remaining terms)

$$\begin{aligned}
& \mathbb{E}_p[|C(0) \cap S_L(2n_1L, 2n_2L)|; |C(0)| < \infty] \\
& \leq \mathbb{P}_p(0 \rightsquigarrow \partial S_L) \times \mathbb{E}_p[|x \in S_L(2n_1L, 2n_2L) : x \rightsquigarrow \partial S_L(2n_1L, 2n_2L)|] \\
& \quad \times \mathbb{P}_p(\exists \text{ white circuit surrounding a site on } \partial S_L \text{ and a site on } \partial S_{(2k-1)L}) \\
& \leq \pi_1(L) \times (C'' L^2 \pi_1(L)) \times C'_5 e^{-C'_6 k}.
\end{aligned}$$

Since there are at most $C^{(3)}k$ rhombi at a distance k for some constant $C^{(3)}$, the previous summation is in both cases less than

$$\sum_{k=1}^{\infty} C^{(3)}k \times C'k^t L^t \times C_1 L^2 \pi_1^2(L) e^{-C_2 k} \leq C^{(4)} \left(\sum_{k=1}^{\infty} k^{t+1} e^{-C_2 k} \right) L^{t+2} \pi_1^2(L),$$

which yields the desired upper bound, as $\sum_{k=1}^{\infty} k^{t+1} e^{-C_2 k} < \infty$.

□

Critical exponents for χ and ξ

The previous lemma reads for $t = 0$:

Proposition 45. *We have*

$$\chi(p) = \mathbb{E}_p [|C(0)|; |C(0)| < \infty] \asymp L(p)^2 \pi_1^2(L(p)). \quad (7.40)$$

In other words, “ $\chi(p) \asymp \chi^{\text{near}}(p)$ ”. It provides the critical exponent for χ :

$$\chi(p) \approx L(p)^2 [L(p)^{-5/48}]^2 \approx [|p - 1/2|^{-4/3}]^{86/48} \approx |p - 1/2|^{-43/18}. \quad (7.41)$$

Recall also that ξ was defined via the formula

$$\xi(p) = \left[\frac{1}{\mathbb{E}_p [|C(0)|; |C(0)| < \infty]} \sum_x \|x\|_{\infty}^2 \mathbb{P}_p(0 \rightsquigarrow x, |C(0)| < \infty) \right]^{1/2}.$$

Using the last proposition and the lemma for $t = 2$, we get

$$\xi(p) \asymp \left[\frac{L(p)^4 \pi_1^2(L(p))}{L(p)^2 \pi_1^2(L(p))} \right]^{1/2} = L(p). \quad (7.42)$$

We thus obtain the following proposition, announced in Section 7.1:

Proposition 46. *We have*

$$\xi(p) \asymp L(p). \quad (7.43)$$

This implies in particular that

$$\xi(p) \approx |p - 1/2|^{-4/3}. \quad (7.44)$$

8 Concluding remarks

8.1 Other lattices

Most of the results presented here (the separation of arms, the theorem concerning arm events on a scale $L(p)$, the “universal” arm exponents, the relations between the different characteristic functions, etc.) come from RSW considerations or the exponential decay property, and remain true

on other regular lattices like the square lattice. The triangular lattice has a property of self-duality which makes life easier, in the general case we have to consider the original lattice together with the matching lattice (obtained by “filling” each face with a complete graph): instead of black or white connections, we thus talk about primal and dual connections. We can also handle bond percolation in this way. We refer the reader to the original paper of Kesten [31] for more details, where results are proved in this more general setting. The only obstruction to get the critical exponents is actually the derivation of the arm exponents at the critical point $p = p_c$ (and only two exponents are needed, for 1 arm and 4 alternating arms).

Now, consider site percolation on \mathbb{Z}^2 for instance. We know that the (hypothetical) arm exponents satisfy $0 < \alpha_j, \alpha'_j, \beta_j < \infty$ for any $j \geq 1$. Hence the a-priori estimate

$$\mathbb{P}_{p_c}(0 \rightsquigarrow_{4, \sigma_4} \partial S_N) \geq N^{-2+\alpha}$$

for some $\alpha > 0$, coming from the 5-arm exponent, remains true: $\alpha_4 < 2$ (and in the same way $\alpha_6 > 2$). Combined with Proposition 34, this leads to the weaker but nonetheless interesting statement

$$L(p) \leq |p - p_c|^{-A} \tag{8.1}$$

for some $A > 0$. Hence $\nu < \infty$, and then $\gamma < \infty$ (if these exponents exist). Using $\alpha_1 < \infty$, we also get $\beta < \infty$.

If we use a RSW construction in a box, we can make appear 3-arm sites on the lowest crossing and deduce that $\alpha_1 \leq 1/3$. Here are rigorous bounds for the critical exponents in two dimensions:

triangular lattice	general rigorous bounds
$\beta = 5/36$	$0 < \beta < 1$
$\gamma = 43/18$	$8/5 \leq \gamma < \infty$
$\nu = 4/3$	$1 < \nu < \infty$

For more details, the reader can consult [31] and the references therein.

8.2 Some related issues

For the sake of completeness, let us mention finally that the way the characteristic length L was defined also allows to use directly the compactness results of [2]. Indeed, the a-priori estimates on arm events coming from RSW considerations are exactly hypothesis (H1) of this paper. This hypothesis implies that percolation interfaces cannot cross too many times any annulus, and thus cannot be too “intricate”: this is Theorem 1, asserting the existence of Hölder parametrizations with high probability.

This regularity property then implies tightness, using (a version of) Arzela-Ascoli’s theorem for continuous functions on a compact subset of the plane. We can thus show in this way the existence of scaling limits for near-critical percolation interfaces.

Let us also mention that the techniques presented here are important to study various models related to the critical regime, for instance Incipient Infinite Clusters [17; 24; 25], Dynamical Percolation [45], Gradient Percolation [39]...

Acknowledgements

I would like to thank W. Werner for suggesting me to look at these questions. He had an important role in reading various intermediate versions of this paper. I also enjoyed many stimulating and enlightening discussions with various people, including V. Beffara, J. van den Berg, F. Camia, L. Chayes, C. Garban, A. Sapozhnikov and O. Schramm.

References

- [1] M. Aizenman, Scaling limit for the incipient spanning clusters, in Mathematics of Multi-scale Materials, IMA Volumes in Mathematics and its Applications **99**, Springer (1998). MR1635999
- [2] M. Aizenman, A. Burchard, Hölder regularity and dimension bounds for random curves, Duke Math. J. **99**, 419-453 (1999). MR1712629
- [3] M. Aizenman, B. Duplantier, A. Aharony, Path crossing exponents and the external perimeter in 2D percolation, Phys. Rev. Lett. **83**, 1359-1362 (1999).
- [4] V. Beffara, V. Sidoravicius, Percolation theory, in Encyclopedia of Mathematical Physics, Elsevier (2006).
- [5] J. Van den Berg, H. Kesten, Inequalities with applications to percolation and reliability, J. Appl. Probab. **22**, 556-569 (1985). MR0799280
- [6] C. Borgs, J.T. Chayes, H. Kesten, J. Spencer, Uniform boundedness of critical crossing probabilities implies hyperscaling, Rand. Struc. Alg. **15**, 368-413 (1999). MR1716769
- [7] C. Borgs, J.T. Chayes, H. Kesten, J. Spencer, The birth of the infinite cluster: finite-size scaling in percolation, Comm. Math. Phys. **224**, 153-204 (2001). MR1868996
- [8] C. Borgs, J.T. Chayes, D. Randall, The van den Berg-Kesten-Reimer inequality: a review, in Perplexing Problems in Probability: Festschrift in Honor of Harry Kesten, Birkhäuser (1999). MR1703130
- [9] A.A. Belavin, A.M. Polyakov, A.B. Zamolodchikov, Infinite conformal symmetry of critical fluctuations in two dimensions, J. Stat. Phys. **34**, 763-774 (1984). MR0751712
- [10] A.A. Belavin, A.M. Polyakov, A.B. Zamolodchikov, Infinite conformal symmetry in two-dimensional quantum field theory, Nucl. Phys. B **241**, 333-380 (1984). MR0757857
- [11] F. Camia, C.M. Newman, Two-dimensional critical percolation: the full scaling limit, Comm. Math. Phys. **268**, 1-38 (2006). MR2249794
- [12] F. Camia, C.M. Newman, Critical percolation exploration path and SLE_6 : a proof of convergence, Probab. Th. Rel. Fields **139**, 473-519 (2007). MR2322705
- [13] F. Camia, L.R.G. Fontes, C.M. Newman, The scaling limit geometry of near-critical 2D percolation, J. Stat. Phys. **125**, 1155-1171 (2006). MR2282484

- [14] F. Camia, L.R.G. Fontes, C.M. Newman, Two-dimensional scaling limits via marked nonsimple loops, *Bull. Braz. Math. Soc.* **37**, 537-559 (2006). MR2284886
- [15] J.T. Chayes, L. Chayes, J. Fröhlich, The low-temperature behavior of disordered magnets, *Comm. Math. Phys.* **100**, 399-437 (1985). MR0802552
- [16] J.T. Chayes, L. Chayes, D. Fisher, T. Spencer, Finite-size scaling and correlation lengths for disordered systems, *Phys. Rev. Lett.* **57**, 2999-3002 (1986). MR0925751
- [17] J.T. Chayes, L. Chayes, R. Durrett, Inhomogeneous percolation problems and incipient infinite clusters, *J. Phys. A Math. Gen.* **20**, 1521-1530 (1987). MR0893330
- [18] J.T. Chayes, L. Chayes, On the upper critical dimension in Bernoulli percolation, *Comm. Math. Phys.* **113**, 27-48 (1987). MR0918403
- [19] J.T. Chayes, L. Chayes, G.R. Grimmett, H. Kesten, R.H. Schonmann, The correlation length for the high-density phase of Bernoulli percolation, *Ann. Probab.* **17**, 1277-1302 (1989). MR1048927
- [20] L. Chayes, P. Nolin, Large scale properties of the IIC for 2D percolation, *Stoch. Proc. Appl.*, to appear.
- [21] A. Desolneux, B. Sapoval, A. Baldassarri, Self-organized percolation power laws with and without fractal geometry in the etching of random solids, in *Fractal Geometry and Applications: A Jubilee of Benoit Mandelbrot*, *Proc. Symp. Pure Math.* **72** Part 2, 485-505 (2004). MR2112129
- [22] R. Diestel, *Graph theory*, 2nd edition, Springer, New York (2000). MR1743598
- [23] G.R. Grimmett, *Percolation*, 2nd edition, Springer, New York (1999). MR1707339
- [24] A.A. Járai, Incipient infinite percolation clusters in 2D, *Ann. Probab.* **31**, 444-485 (2003). MR1959799
- [25] A.A. Járai, Invasion percolation and the incipient infinite cluster in 2D, *Comm. Math. Phys.* **236**, 311-334 (2003). MR1981994
- [26] H. Kesten, The critical probability of bond percolation on the square lattice equals $1/2$, *Comm. Math. Phys.* **74**, 41-59 (1980). MR0575895
- [27] H. Kesten, *Percolation theory for mathematicians*, Birkhäuser, Boston (1982). MR0692943
- [28] H. Kesten, The incipient infinite cluster in two-dimensional percolation, *Probab. Th. Rel. Fields* **73**, 369-394 (1986). MR0859839
- [29] H. Kesten, A scaling relation at criticality for 2D-percolation, in *Percolation theory and ergodic theory of infinite particle systems*, *IMA Volumes in Mathematics and its Applications* **8**, 203-212 (1987). MR0894549
- [30] H. Kesten, Subdiffusive behavior of random walk on a random cluster, *Ann. I.H.P. Sec. B* **22**, 425-487 (1986). MR0871905

- [31] H. Kesten, Scaling relations for 2D-percolation, *Comm. Math. Phys.* **109**, 109-156 (1987). MR0879034
- [32] H. Kesten, V. Sidoravicius, Y. Zhang, Almost all words are seen in critical site percolation on the triangular lattice, *Elec. J. Probab.* **3**, paper no.10 (1998). MR1637089
- [33] G.F. Lawler, *Conformally invariant processes in the plane*, AMS (2005). MR2129588
- [34] G.F. Lawler, O. Schramm, W. Werner, Values of Brownian intersection exponents I: Half-plane exponents, *Acta Mathematica* **187**, 237-273 (2001). MR1879850
- [35] G.F. Lawler, O. Schramm, W. Werner, Values of Brownian intersection exponents II: Plane exponents, *Acta Mathematica* **187**, 275-308 (2001). MR1879851
- [36] G.F. Lawler, O. Schramm, W. Werner, One-arm exponent for critical 2D percolation, *Elec. J. Probab.* **7**, paper no.2 (2002). MR1887622
- [37] R. Langlands, P. Pouliot, Y. Saint-Aubin, Conformal invariance in two-dimensional percolation, *Bull. Amer. Math. Soc.* **30**, 1-61 (1994). MR1230963
- [38] G.J. Morrow, Y. Zhang, The sizes of the pioneering, lowest crossing and pivotal sites in critical percolation on the triangular lattice, *Ann. Appl. Probab.* **15**, 1832-1886 (2005). MR2152247
- [39] P. Nolin, Critical exponents of planar gradient percolation, *Ann. Probab.*, to appear.
- [40] P. Nolin, W. Werner, Asymmetry of near-critical percolation interfaces, *J. Amer. Math. Soc.*, to appear.
- [41] A.M. Polyakov, Conformal symmetry of critical fluctuations, *JETP Letters* **12**, 381-383 (1970).
- [42] D. Reimer, Proof of the van den Berg-Kesten conjecture, *Combin. Probab. Comput.* **9**, 27-32 (2000). MR1751301
- [43] B. Sapoval, M. Rosso, J.F. Gouyet, The fractal nature of a diffusion front and the relation to percolation, *J. Phys. Lett.* **46**, 146-156 (1985).
- [44] O. Schramm, Scaling limits of loop-erased random walks and uniform spanning trees, *Israel J. Math.* **118**, 221-288 (2000). MR1776084
- [45] O. Schramm, J.E. Steif, Quantitative noise sensitivity and exceptional times for percolation, *Ann. Math.*, to appear.
- [46] S. Smirnov, Critical percolation in the plane: conformal invariance, Cardy's formula, scaling limits, *C. R. Acad. Sci. Paris Sér. I Math.* **333**, 239-244 (2001). MR1851632
- [47] S. Smirnov, W. Werner, Critical exponents for two-dimensional percolation, *Math. Res. Lett.* **8**, 729-744 (2001). MR1879816
- [48] W. Werner, Random planar curves and Schramm-Loewner Evolutions, in 2002 St-Flour summer school, *L.N. Math.* **1840**, 107-195 (2004). MR2079672
- [49] W. Werner, Critical two-dimensional percolation, Lecture notes from the IAS/Park City 2007 summer school, in preparation.