

## *Review Article*

# **Stability and Control for Energy Production Parametric Dependence**

**Maurizio Carlini,<sup>1</sup> Sonia Castellucci,<sup>2</sup> Mirko Guerrieri,<sup>3</sup>  
and Tommaso Honorati<sup>4</sup>**

<sup>1</sup> CIRDER, University of Tuscia, Via Cavour 23, 01028 Orte, Italy

<sup>2</sup> DiSAFRi, University of Tuscia, Via San Camillo de Lellis s.n.c., 01100 Viterbo, Italy

<sup>3</sup> GEMINI, University of Tuscia, Via San Camillo de Lellis s.n.c., 01000 Viterbo, Italy

<sup>4</sup> DiPROP, University of Tuscia, Via San Camillo de Lellis s.n.c., 01100 Viterbo, Italy

Correspondence should be addressed to Sonia Castellucci, sonia.castellucci@libero.it

Received 1 February 2010; Accepted 1 June 2010

Academic Editor: Massimo Scalia

Copyright © 2010 Maurizio Carlini et al. This is an open access article distributed under the Creative Commons Attribution License, which permits unrestricted use, distribution, and reproduction in any medium, provided the original work is properly cited.

The activities of plant cultivation in Italy are provided by prefabricated structures that are designed to avoid any preliminary study of optical and thermal exchanges between the external environment and the green house. Designers mainly focused on the heating and cooling system to obtain climate beneficial effects on plant growth. This system involves rather significant operating costs which have driven the interests of designers, builders, and farmers to pursue constructive solutions such as the optimization and control of energy flows in the system. In this paper we take into account a model of greenhouse for plant cultivation to be located in Central Italy. For the optimal design of a greenhouse, simulations of heat exchange and flow of energy have been made in order to maximise the cooling system consumption of energy.

## **1. Introduction**

The use of greenhouses for growing plants is widely used in Italy. The design and implementation of greenhouses is done without the study of energy exchanges between the external environment inside the greenhouse. Climatic conditions are evaluated only on the plant species planted without verifying the construction parameters of the greenhouse or efficiency of air conditioning systems. This paper verifies the efficiency of air conditioning systems used in the greenhouse and, moreover, the proper management control systems of climate parameters with TRNSYS 16.

The climate control inside the greenhouses was treated and developed in various ways, here are some articles that discuss the issue with the methodology of solving the problem.

(i) “A simple greenhouse climate control model incorporating effects of ventilation and evaporative cooling” by T. Boulard and A. Baille (INRA—Station de Bioclimatologie, BP 91 84143 Montfavet Cedex, France) has analyzed a system of linear control that allows you to represent the heat transfer mechanisms in a greenhouse with online control.

(ii) “Greenhouse climate control. An integrated approach” by J.C. Bakker, G.P.A. Bot, H. Challa and N.J. Van de Braak (Editors), Wageningen Pers, Wageningen, The Netherlands, 1995. 279 pp., ISBN 90-74134-17-3: this paper lists all the reports of the climate of greenhouses according to different types of crops grown. They checked all the control systems of air conditioning to allow a more rational use of energy resources.

(iii) SE—Structures and Environment: A Strategy for Greenhouse Climate Control, Part I: Model Development M. Trigui, S. Barrington and L. Gauthier. SE—Structures and Environment: A Strategy for Greenhouse Climate Control, Part II: Model Validation M. Trigui, S. Barrington and L. Gauthier: Studied in these articles is the climate control system and verified mathematical models on crop.

(iv) “Development of a standardized fieldbus-based greenhouse climate control” by Olga Plaksina and Thomas Rausch. Institute of Computer Technology, Vienna University of Technologies Gusshausstrasse 27-29, A-1040 Vienna, Austria: the work concentrates on the feasibility of building automation technologies for the climate control in growing environments. This includes, but is not limited to, the acquisition and processing of environmental data. The paper analyzes the requirements for greenhouse climate control and compares these demands to those of residential building automation. The authors provide a concept of a KNX-based control system for this application domain and give an outlook on the future phases of the project.

(v) *Sensitivity Analysis of an Optimal Control Problem in Greenhouse Climate Management* E. J. Van Henten, Department of Greenhouse Engineering, Institute of Agricultural and Environmental Engineering (IMAG b.v.), P.O. Box 43, NL-6700 AA, Wageningen, The Netherlands: this paper describes the methodology and results of a sensitivity analysis of an optimal control problem in greenhouse climate management. The methodology used is based on variational arguments and requires a single solution of the optimal control problem, resulting in a computationally efficient technique. The example considered deals with economic optimal greenhouse climate management during the cultivation of a lettuce crop. The sensitivity analysis produced valuable insight into the performance sensitivity and operation of the controlled process. Both the model description of crop growth and production as well as the outside climate conditions have a strong impact on the performance. Humidity control plays a dominant role in economic optimal greenhouse climate management, emphasising the need for an accurate description of humidity effects on crop growth and production, either in terms of quantitative models or time-varying constraints on the humidity level in the greenhouse. Finally, the study revealed that the dynamic response times in the greenhouse climate are not limiting factors for economic optimal greenhouse climate control.

(vi) “Time-scale decomposition of an optimal control problem in greenhouse climate management” by E.J. Van Henten and J. Bontsema Wageningen UR Greenhouse Horticulture, P.O. Box 16, NL-6700 AA Wageningen, The Netherlands, Farm Technology Group, Wageningen University, P.O. Box 17, NL-6700 AA Wageningen, The Netherlands: based on differences in dynamic response times in the crop production process, a hierarchical decomposition of greenhouse climate management is proposed. To a large extent the proposed decomposition builds on the time-scale decomposition of singularly perturbed systems commonly found in the literature. Main difference with these existing theoretical concepts is that the proposed decomposition is able to deal with rapidly fluctuating deterministic external

Table 1

Southern Italy	100 t
Netherlands	340 t
United Kingdom	480 t
Sweden	550 t

inputs or disturbances acting on the fast subprocesses. For an example of economic optimal greenhouse climate management during one lettuce production cycle, the decomposition was successfully evaluated in simulations. Using these favourable results, a hierarchical concept for economic optimal greenhouse climate management is derived and discussed in view of application in horticultural practice.

This paper addresses the problem of control of air conditioning of greenhouses, from a detailed analysis of the climatic conditions outside the greenhouse. The simulation with the TRNSYS is possible to have the reaction of the air conditioning system of the greenhouse daily according to the climatic conditions of the area where the greenhouse is planted. These values are obtained using mathematical models based on nonlinear control systems POI. This makes it possible to evaluate the energy consumption related to cooling the greenhouse, checking the systems more affordably for heating or cooling of greenhouses.

Unlike the articles cited in this work we can immediately assess the energy consumption in a greenhouse, that in fact created a simulation model that allows such an assessment depending on various types of air conditioning systems.

## 2. Preliminary Remarks

### 2.1. State of the Art in the Literature and Types of Greenhouse Heating

Climate control in greenhouses represents 20%–30% of production costs, therefore it is important to reduce such costs. Therefore the fact that the direct annual consumption of energy per hectare is about 0.25 toe per crops in open fields against the approximately 7 toe for the greenhouse ones has to be taken into consideration. Moreover for tomatoes grown in greenhouse the consumption of heating oil per hectare varies greatly according to latitudes. Table 1 shows average values for Southern Italy, The Netherlands, United Kingdom, and Sweden.

The purpose of this study is based upon TRNSYS program that simulates the control system of air conditioning in greenhouses according to the time of the year. In particular, the simulation will be made from historical data nonlinear climatic conditions outside the greenhouse [1]. From these data we intend to evaluate the nonlinear heat flows that develop with more nonlinear function of temperature control and humidity inside the greenhouse.

#### 2.1.1. Heating Installations

The criteria for selecting a heating system for a greenhouse are numerous and can greatly influence the cost of producing the final product. Schematically they can be distinguished by

- (i) thermal needs,
- (ii) type of crop and farming system,

- (iii) flexibility of use,
- (iv) uniform temperature in the vicinity of plants,
- (v) restricted movement of air masses,
- (vi) efficiency and economy.

Generally in the design phase the following simplified formula for calculating the heating requirements of greenhouses [2] is considered:

$$Q = K_r S(t_i - t_e) \quad (2.1)$$

where  $Q$  is heat (kcal/h),  $K_r$  is overall heat transfer coefficient (kcal/h m<sup>2</sup> °C),  $S$  is total area of walls (m<sup>2</sup>),  $t_i$  is indoor temperature (°C),  $t_e$  is outdoor temperature (°C).

Equation (2.1) is acceptable for the design of the heating system as early in the morning, when the following conditions are fulfilled: greater thermal availability [3], the energy contribution of the sun through the soil and losses are negligible, the activity of the crop is minimum, and cultural operations are not carried out, also not using ventilation and hence the losses for air exchange are limited.

The air conditioning system regardless of the type of power (gas, oil, etc.) is basically made by

- (i) a boiler (a draw or pressurized),
- (ii) a heat exchanger (air or water),
- (iii) pipes,
- (iv) heating elements or heaters,
- (v) sensors and controllers for the control of climatic parameters.

An outline of the types of systems of heat distribution is shown [4] in Figure 1.

### 2.1.2. Systems for Air Heating

Hot air generators are the most popular applications for heating greenhouses, to attain rapid warming of the greenhouse at the desired temperature. They are also easy to install and of cheap price. Compared to the types of heat distribution by means of heating elements, however, they have some disadvantages of agronomic such as uneven distribution of heat stagnation of hot air near the foot of greenhouse air temperature too high for plants affected by the flow air, greater energy consumption [5].

The types of systems for air heating are distinguished as those with direct spread or duct, either fixed or mobile, for small, medium, or large power, liquid fuel, solid, or gaseous.

Under the direction of flow of hot air inside the greenhouse there can be distinguished [6]:

- (1) horizontal projection unit heaters (fan-jet), Figure 2,
- (2) vertical projection heaters, Figure 3.

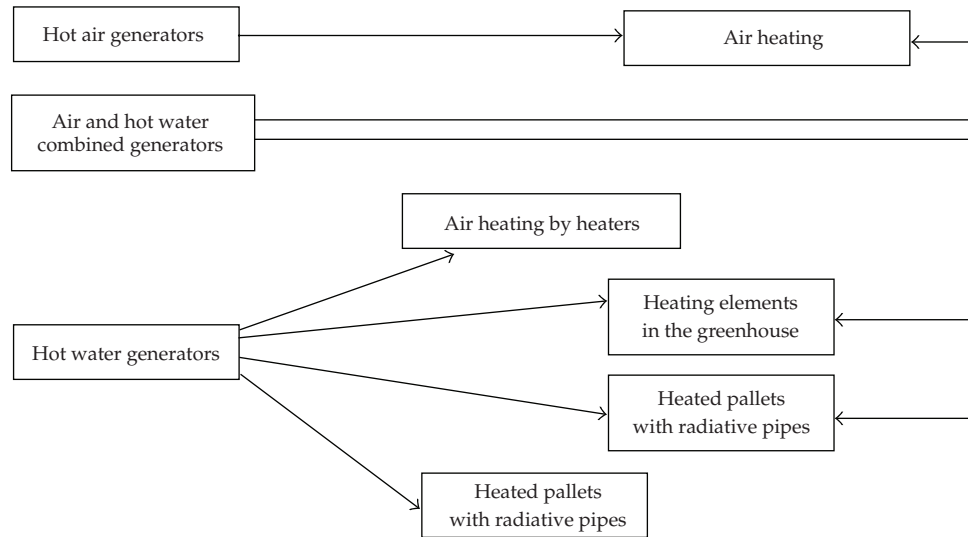

**Figure 1:** Diagram of the types of heat distribution systems.

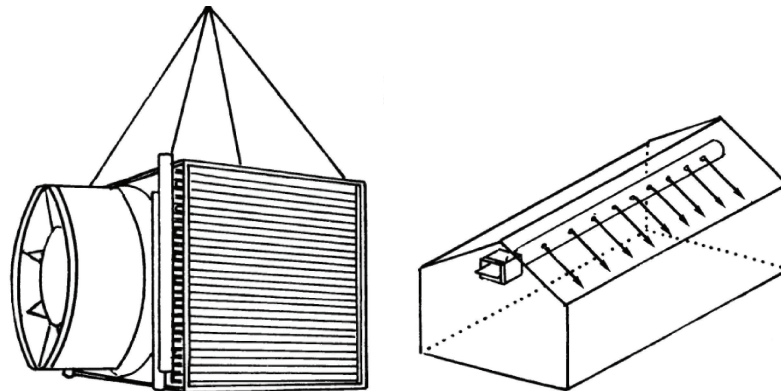

**Figure 2:** Horizontal projection unit heaters.

### *Radiant Heating Systems Bodies*

In this solution the water leaves the boiler through a pump and enters the pipe until you reach the heating elements [7]. Generally, the outlet water temperature is around 80–85°C, and the return is to 65–70°C, with optimum thermal gradient of 15°C. The installation diagram is shown in Figure 4.

According to the arrangement of heating elements there can be distinguished [8]:

- (i) heating of the walls (Figure 5),
- (ii) heating of the substrate,
- (iii) heating of the floor (Figure 6),
- (iv) heating of the soil,
- (v) heating of pallets (Figure 7).

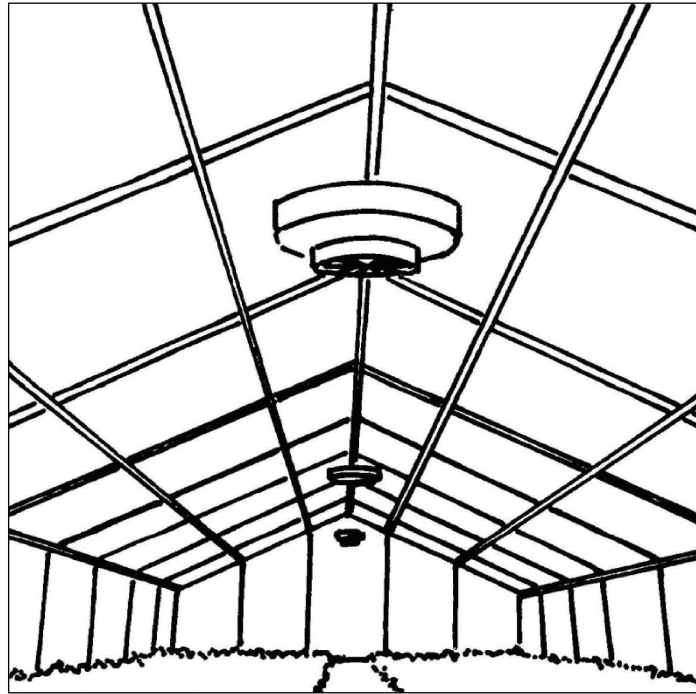

Figure 3: Vertical projection heaters.

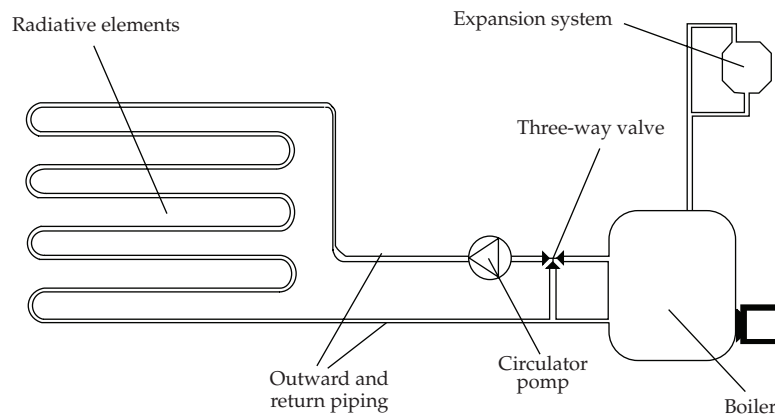

Figure 4: Scheme radiant heating system bodies.

### *Cooling System*

The cooling in greenhouses can be achieved through four distinct types of plant [9]:

- (i) natural ventilation,
- (ii) shading achieved by partial coverage of surfaces exposed to the sun,

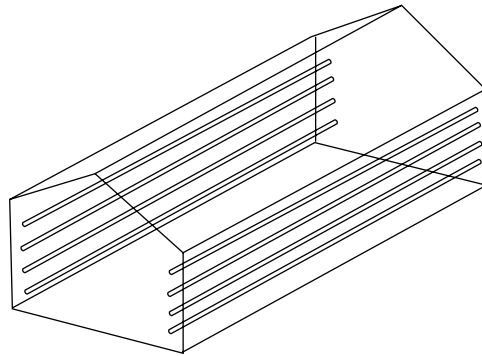

Figure 5: Heating of the walls.

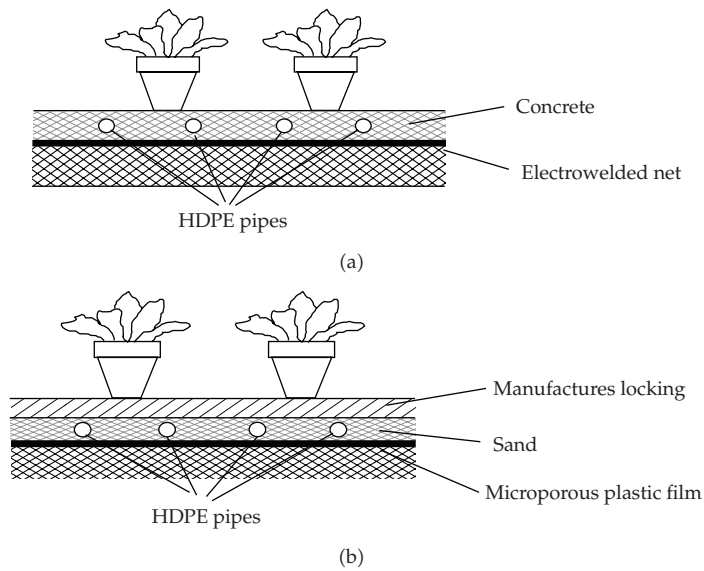

Figure 6: Heating of the floor: (a) concrete slab, (b) floor made of car manufacturers' blockers.

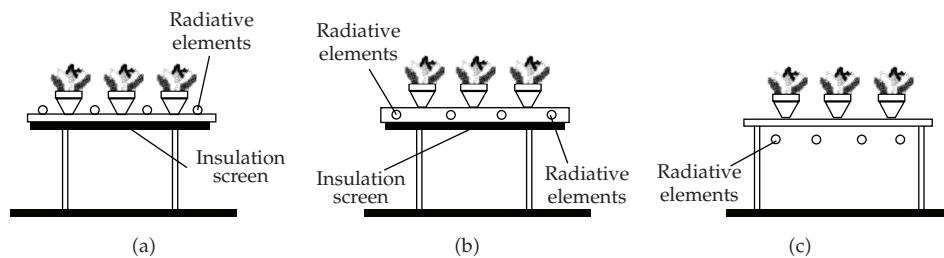

Figure 7: Central heating of pallets: (a) heating elements at the top of the pallet, (b) heating elements inserted in the pallet, (c) heating elements disposed below the pallet.

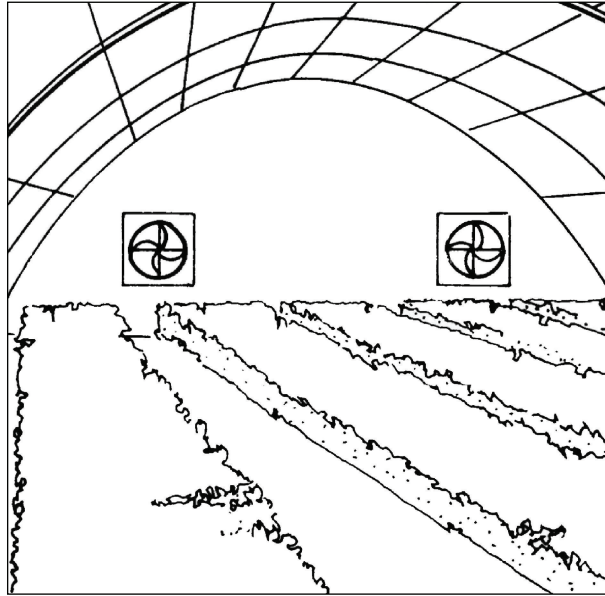

Figure 8: Forced Ventilation System.

(iii) ventilation,

(iv) evaporation of water by cooling system or high-pressure spraying system (high-pressure fogs).

#### *Natural Ventilation*

Natural ventilation is achieved by opening windows along the side walls and on the top to exploit the stack effect.

#### *Forced Ventilation*

Forced ventilation is practiced with large electrohelical ceiling fans, low-speed shutter system and provided with a flow rate of ventilation of 40 times the volume of gases (Figure 8).

#### *Cooling System*

The Cooling System [10] allows for cooling with humidification of the environment causing axial fans with the passage of outside air through a moistened panel (Figure 9).

#### *High-Pressure Spraying (High-Pressure Fogs)*

By spraying at high pressure (high-pressure fogs), cooling is achieved by humidifying the environment through dense fog through spray nozzles [11].

The pipes with spray nozzles (7 liters/h every 7.5 m<sup>2</sup> of glass) have been installed about 2 m above the ground; water is sent from a service tank through a high-pressure pump (35–40 atm) to the nozzles.



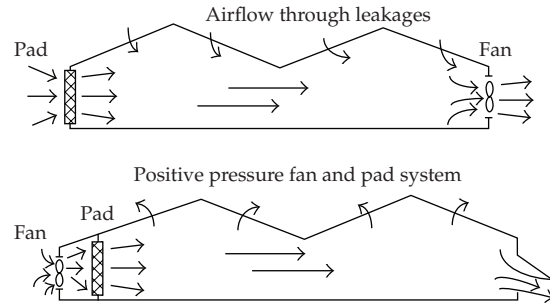

**Figure 9:** Scheme of cooling system.

The mathematical models commonly used for sizing of cooling systems are as follows.

- (1) Loss of sensible heat for ventilation [12]:

$$Q' = \frac{Vv_r(T_i - T_e)}{3600}, \quad (2.2)$$

where  $Q'$  is loss of sensible heat for ventilation (W),  $V$  is volume of the greenhouse ( $\text{m}^3$ ),  $v_r$  is air infiltration rate (1/h),  $T_i$  is indoor temperature ( $^{\circ}\text{C}$ ),  $T_e$  is outdoor temperature ( $^{\circ}\text{C}$ ),

- (2) Loss of latent heat for ventilation:

$$Q = \frac{Vv_r r(x_i - x_e)}{3600} \quad (2.3)$$

where  $Q$  is loss of latent heat for ventilation (W),  $V$  is volume of the greenhouse ( $\text{m}^3$ ),  $v_r$  is air infiltration rate (1/h),  $r$  is latent heat of vaporization (J/kg),  $x_i$  is indoor umidity (kg/kg),  $x_e$  is outdoor umidity (kg/kg).

- (3) Flow Ventilation:

$$qv = \left( c_1 b \exp\left(-\frac{b}{c_2}\right) \right) UA \quad (2.4)$$

where  $qv$  is flow ventilation ( $\text{m}^3/\text{s}$ ),  $U$  is outdoor wind speed (m/s),  $A$  is total area of the windows ( $\text{m}^2$ ),  $b$  is opening angle of the windows ( $^{\circ}$ ),  $c_1$  and  $c_2$  is constants that depend on the type of window.

The case study considered the most common type of heating in greenhouses that applied heating air heaters with vertical flow, regulated by the control system of proportional representation through a temperature sensor [13].

For cooling systems of the greenhouse were used for opening windows to allow natural ventilation.

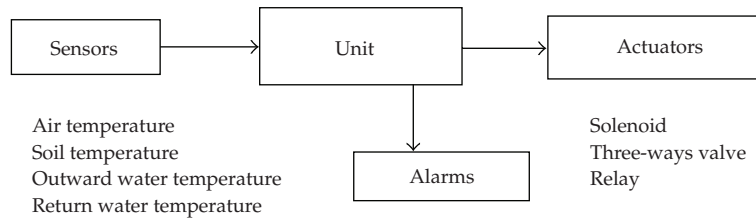

Figure 10: Scheme of air conditioning control unit.

### 3. Control System of Air Conditioning

A control system of air conditioning is typically composed of sensors, controller, actuators and alarms [14]. The sensors are sensors for detecting temperatures (air, soil, pipes). A simplified diagram is shown in Figure 10.

The audit is to keep the temperature and humidity of the system as close as possible to a desired temperature and humidity (the set point) and to compensate as effectively as possible the effects of changes in the external environment (e.g., variations in the heat), and quickly follow the changes in set points that can be requested [15].

The relevant parameters for good control are, therefore,

- (1) *Accuracy*: the actual temperature should be as close as possible to set-point.
- (2) *Stability*: fluctuations around the set-point must be small.
- (3) *Readiness*: the system should follow set-point changes as soon as possible.

There are several methods of control:

- (i) ON/OFF,
- (ii) Proportional control,
- (iii) Full control,
- (iv) Control derivative.

Sketch a generic system (Figure 11) which we want to check its physical condition through a particular VC controlled variable (e.g., a sample temperature, the speed of a moving rotation or position, etc.) [16]. The size VC will be measured by a transducer that allows real time to know the present value of VM size in question. In order to effectively influence the system and hence to obtain a change in the controlled variable, you should provide an input into the system on the size manipulation GM. The desired value to be obtained for VC and represented by SP (set point) and both of these two values (SP and VM) will be homogeneous (e.g., are both voltage signals) so that they can be compared among themselves to calculate the error  $E$  ( $E = SP - VM$ ) [17]. And the error signal to be sent to the controlled system must be processed by a function block that generates the appropriate value of the signal to be sent; GM actually the entrance to the controlled system. Below a block diagram that describes this generic system reaction is reported.

The function block that controls the controlled system can be done in various ways corresponding to different mathematical functions. The most “simple” performed by a comparator (*on-off control*), with GM and its one size only two values (all-nothing) [18].

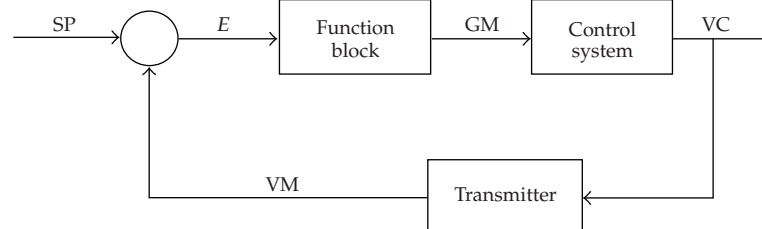

**Figure 11:** Schematic diagram of control.

Alternatively you open the field to function blocks capable of generating quantities manipulated GM as analog functions of the error  $E$ . We have thus blocks proportional, integral and derivative (PID, PI, PD).

### *On/Off Control*

In this mode the air conditioning system has a unique power level that can be switched on (if the climate parameters are below the setpoint) or off (if vice versa parameters are higher). In this mode you can get good accuracy and promptness, and the system can respond well to changes in set-point. However, it may be very stable, since the controller will work for cycling the temperature above and below the set point. The control law of the ON/OFF is very simple [19]:

$$s(t) = 0 \quad \text{per } e < 0, \quad s(t) = 1 \quad \text{per } e > 0 \quad (3.1)$$

where  $s$  is control action,  $e = y_{\text{ref}} - y$  is the tracking error,  $y$  is output value,  $y_{\text{ref}}$  reference value.

### *Proportional Control*

This system eliminates the problem of fluctuations in temperature and humidity using a continuously adjustable output power from the air conditioning system: it is proportional to the magnitude of the difference between the actual temperature and setpoint. For example, a large error will produce a large negative voltage to the heater to correct the error [20].

If the power output was proportional to the error in the entire range of the instrument, it would require a negative error equal to half the range for maximum power of the heater. The accuracy would be very unsatisfactory.

It tackles this by introducing the parameter of *proportional band*. The proportional band is usually expressed in percentage fraction of the interval of operation of the instrument; within the proportional band the output power is proportional to the error; outside of this band the power is maximum or zero.

Reducing the proportional band (i.e., increasing the gain) improves the accuracy of the controller, as just a smaller error for a given change in the output power. But there is a limit to the increase of gain: at some point the system begins to self-oscillate, and the gain should be reduced. In fact a system of proportional band is not on-off system [21].

The law of proportional control is

$$s(t) = K_c e(t), \quad (3.2)$$

where  $s$  is control action,  $e = y_{\text{ref}} - y$  is the tracking error,  $y$  is output value,  $y_{\text{ref}}$  reference value,  $K_c$  is constant proportional action gain,  $t$  is operation time.

### *Proportional Integral Control*

To improve the accuracy of the proportional control full control is introduced. Consider a controlled system with proportional representation, with the proportional band not large enough to induce self-oscillations. The result is a stable system but not overly accurate [22]. Suppose we send a signal of residual error to an integrator, whose output is coupled to that of proportional representation. The result is that the power output increases until the temperature equals the set point. At this point the integrator output will be canceled, and this will keep a constant power. The integrator, however, could induce oscillations. This is avoided by the presence of proportional representation.

The integral control is characterized by the integration time (integral action time, commonly RESET), defined as the time required for the output to vary from zero to its maximum in the presence of an error equal to the fixed proportional band.

The RESET can be specified as a time or as a frequency (repetitions per minute).

To prevent the integral control from inducing oscillations in the system is good to the integration time at least to the time constant system response [23].

If the set-point is likely to vary considerably over time that the system uses to approach the new set-point, integrator is saturated, resulting in an overshoot when the temperature finally reaches the set point. It is so convenient to keep the integrator to zero until the temperature does not fall within the proportional band. The law of integrated and proportional control is

$$s(t) = K_c e(t) + \frac{K_c}{\tau_i} \int_0^t e(t) dt \quad (3.3)$$

where  $s$  is control action,  $e = y_{\text{ref}} - y$  is the tracking error,  $y$  is output value,  $y_{\text{ref}}$  reference value,  $K_c$  is constant proportional action gain,  $t$  is operation time,  $\tau_i$  is integral constant action.

### *Proportional Integrated Derivative PID Control*

The combination of proportional control and integral control ensures stability and accuracy; however if the set point is changed, it is likely that the system approximates the new set point with little readiness or alternately with good quickness but producing an overshoot [24]. This is edited by *derivative control*. As the name suggests, the derivative control measures the time derivative of the error signal of the system and changes the output power to reduce the speed of change.

Even the derivative control is characterized by a characteristic time, the *time derivative* (derivative action time, the rate which can be given either as a time or frequency). If the error signal is changing rapidly, at a rate proportional band in a time derivative, then the output of the shunt is sufficient to lead to zero output power.

In many cases, the PI control (proportional and integrated) is sufficient, in others it is also necessary in the time derivative [25].

The determination of the three parameters of the PID gains can be made empirically in the logical order in which they were described in controls or in modern instruments and often have the opportunity to let the controller itself to determine responsiveness of the system by applying a series of pulses deltiformi power and measuring the response time of your system.

Very often, then the optimal PID parameters are also dependent on the working temperature of a given system. The optimization of the parameters of the PID is then repeated, with minor adjustments continuing.

The law that controls the PID is

$$s(t) = K_c e(t) + \frac{K_c}{\tau_i} \int_0^t e(t) dt + K_c \tau_d \frac{de(t)}{dt} \quad (3.4)$$

where  $s$  is control action  $e = y_{\text{ref}} - y$  is the tracking error,  $y$  is output value,  $y_{\text{ref}}$  reference value,  $K_c$  is constant proportional action gain,  $t$  is operation time,  $\tau_d$  is derivative action constant.

#### 4. Greenhouse Model with TRNSYS

The TRNSYS is commonly used to simulate transient heat transfer for the design and control of power systems using renewable energy sources. Another frequent use of software is now on the energy certification for homes, offices, shops, restaurants, and industries. In this sense the present work is an example of using the software for agricultural systems [26].

The greenhouse is considered a construction steel structure of prefabricated type STO, used for growing flowers and plants. It is covered with glass cover horizontal beam pattern and small flat foot north-south.

The approach of the model was carried out by using the program TRNSYS Simulation Studio. Work done starting with the path led to the construction of a multizone building, which is divided into multiple steps where the user enters the data on the building and its location in space. The data required by the software at this stage will be used for the automatic construction of the project and its connections between the components [27].

During construction of the project there is also the source of meteorological data that will be used in the simulation. This is indeed a link with the Type 109 (Weather Data Processor), and in this case study the meteorological station of Rome Fiumicino (Airport) was selected.

The meteorological station of Rome Fiumicino is the weather station of reference for the Air Force Meteorological Service and the World Meteorological Organization concerning the city of Rome and its coastline.

The outline of the project is as shown in Figure 12: rome is the source of meteorological and solar radiation to Rome (Fiumicino), unit change is converter unit, psychrometrics are computer psychrometric parameters, sky Temp is computer temperature of the sky, greenhouse isgreenhouse (Type 56), heating is the heating system, cooling is the cooling

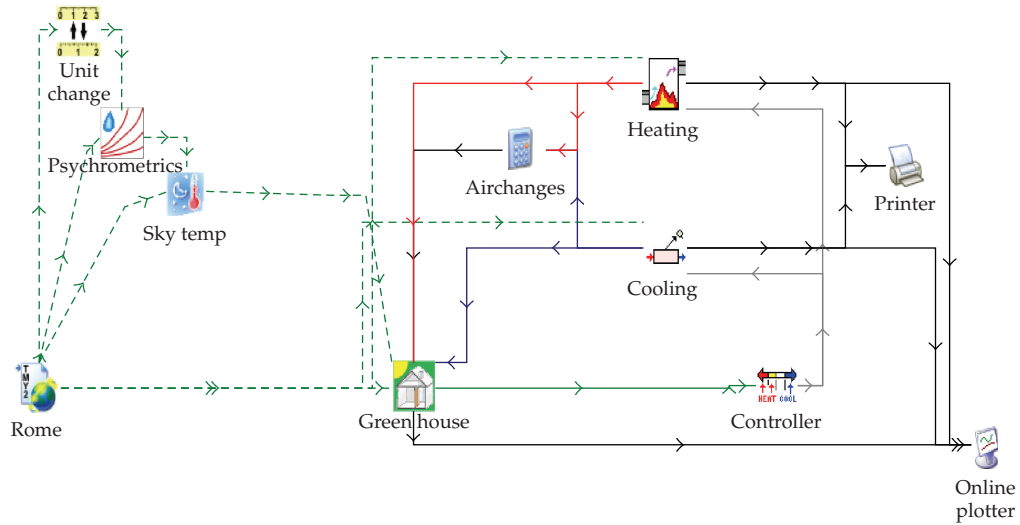

Figure 12: Air conditioning system diagram with TRNSYS.

system, controller is climatization controller, airchanges is calculator for spare parts for air heating/cooling, online plotter is computer graphics, printer is printer (writes a file with the values of variables required).

As for the greenhouse, we have chosen the climate system most widely used, that is, a boiler with a hydrometer vertical heated by placing hot air and a cooling system for summer cooling [28]. The system is controlled by a thermostat where you can set the reference temperature. Consider in detail the models used for equipment and air conditioning control.

### Simple Furnace/Air Heater

The heater can be controlled externally or set to automatically try and attain a set point temperature. The furnace is bound by a heating capacity and an efficiency [29]. Thermal losses from the furnace are based on the average air temperature. The outlet state of the air is determined by an enthalpy-based energy balance that takes pressure effects into account.

#### 4.1. Mathematical Description

The operation is governed by the energy balance shown in Figure 13.

where  $h_{in}$  and  $h_{out}$  refer to the enthalpy of air entering and exiting the furnace, respectively. Thermal loss calculations are made based on the average temperature of air in the furnace, and  $q\eta$  is the capacity of the furnace multiplied by its overall efficiency. In other words,  $q\eta$  is the amount of energy actually transferred from the fuel to the air in the furnace. The energy balance is written as shown in (4.1) so as to solve for the enthalpy of air exiting the furnace [30]

$$h_{air,out} = h_{air,in} + \frac{q\eta}{\dot{m}} - \frac{UA}{\dot{m}} (\bar{T} - T_{env}), \quad (4.1)$$

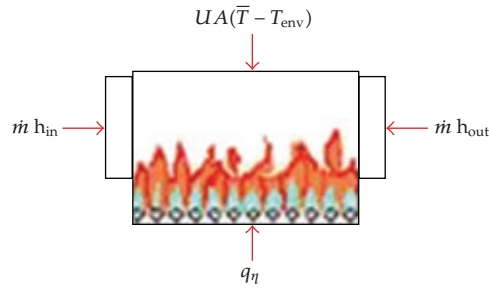

**Figure 13:** Furnace Energy Balance.

where  $h_{air,in}$  is enthalpy of air entering the furnace (kJ/kg·K),  $h_{air,out}$  is enthalpy of air exiting the furnace (kJ/kg·K),  $m_{air}$  is mass flow rate of air (entering mass flow rate = exiting mass flow rate) (kg/hr),  $q_{max}$  is capacity of the furnace (kJ/hr),  $q_{\eta}$  is maximum heating rate of the furnace (accounting for efficiency effects) (kJ/hr),  $UA$  is overall thermal loss coefficient for the furnace (kJ/K),  $T$  is average temperature of air in the furnace (C),  $T_{env}$  is temperature of the air surrounding the furnace (for loss calculations) (C).

Because the outlet temperature of the air is not initially known, Type uses an iterative process to arrive at the exiting air condition. The enthalpy of entering air is calculated and returned by the TRNSYS PSYCHROMETRICS routine whereupon (4.1) energy balance is solved first guessing that the inlet and outlet air temperatures are equal [31]. The resulting outlet enthalpy is passed back to the PSYCHROMETRICS routine, which in turn returns a new outlet air temperature. The new outlet air temperature is used to modify the energy balance, affecting both the thermal loss term and the energy exiting through the air stream. Iteration continues until the temperature of outlet air returned from PSYCHROMETRICS changes to less than 0.01°C. This default tolerance may be modified in the Type source code if desired.

Type also accounts for air pressure drop across the furnace. The pressure drop is applied to the air outlet conditions whether or not the furnace is in operation and whether or not air is flowing. The assumption that pressure drop occurs without regard to flow is made so that TRNSYS is better able to converge upon a solution when a system starts up. Users wishing to ignore pressure effects should simply set the pressure drop parameter to zero [32].

#### 4.1.1. Auxiliary Cooling Device

The auxiliary cooling device is the complement to the Simple Furnace/Air Heater. Instead of adding heat to a flow stream, the auxiliary cooling device removes heat [32]. The cooler is designed to remove heat from the flow stream at a user determined rate,  $Q_{max}$ , whenever the external control input,  $\gamma$ , is equal to 1 and the cooling unit outlet temperature is greater than a user specified minimum,  $T_{set}$ .

By providing a control function of 0 or 1 and setting  $T_{set}$  to a very high value with a reasonably low value of  $Q_{max}$ , Type 6 will perform like an externally controlled ON/OFF heating device. Users should be aware that the maximum thermal energy transfer to the flowstream is not  $Q_{max}$  but  $\eta_{htr}^* Q_{max}$ .

### Mathematical Description

If  $T_i \geq T_{\text{set}}$ ,  $m_i \leq 0$ , or  $\gamma = 0$ , then  $T_o = T_i$ ,  $m_o = m_i$ ,  $Q_{\text{loss}} = 0$ ,  $Q_{\text{fluid}} = 0$ , and  $Q_{\text{aux}} = 0$ .  
Otherwise, an energy balance on the steady-state cooling reveals [33]

$$\begin{aligned}
 T_o &= \frac{\dot{Q}_{\text{max}}\eta_{\text{htr}} + \dot{m}C_{\text{pf}}T_i + UA T_{\text{env}} - (UA T_i/2)}{mC_{\text{pf}} + (UA/2)}, \\
 m_o &= m_i, \\
 Q_{\text{aux}} &= Q_{\text{max}}, \\
 Q_{\text{fluid}} &= m_o C_{\text{pf}}(T_i - T_o), \\
 \bar{T} &= \frac{(T_o + T_{\text{in}})}{2}, \\
 Q_{\text{loss}} &= UA(\bar{T} - T_{\text{env}}) + (1 - \eta_{\text{htr}})Q_{\text{max}},
 \end{aligned} \tag{4.2}$$

unless  $T_o > T_{\text{set}}$ , then,

$$\begin{aligned}
 T_o &= T_{\text{set}}, \\
 m_o &= m_i, \\
 Q_{\text{fluid}} &= m_o C_{\text{pf}}(T_{\text{set}} - T_i), \\
 \bar{T} &= \frac{(T_{\text{set}} + T_{\text{in}})}{2}, \\
 Q_{\text{loss}} &= UA(\bar{T} - T_{\text{env}}) + (1 - \eta_{\text{htr}})Q_{\text{max}}, \\
 Q_{\text{aux}} &= \frac{mC_{\text{pf}}(T_{\text{set}} - T_i) + UA(\bar{T} - T_{\text{env}})}{\eta_{\text{htr}}}
 \end{aligned} \tag{4.3}$$

where  $Q_{\text{aux}} = Q_{\text{loss}} + Q_{\text{fluid}}$ .

#### 4.1.2. Three-Stage Room Thermostat

A three-stage room thermostat is modeled to output three on/off control functions that can be used to control a system having a solar heat source, an auxiliary heater, and a cooling system [34].

This controller is to be used to control systems on temperature levels. The controller commands cooling at high room temperatures, first-stage (solar source) heating at lower room temperatures and second stage (auxiliary source) heating at even lower room temperatures. The user has the option, through parameter  $ISTG$ , to disable first-stage heating during second stage heating and the capability, through parameter  $T_{\text{min}}$ , to disable first stage heating whenever the source temperature is too low. Although solar heating is specified in



the description of this component, any three-stage heating system may be controlled using the TYPE 8 routine [35].

In many heating applications, the desired room temperature may depend on the time of day or the day of the week. This variation of the heating on/off temperatures is modeled here using an optional "set back" control function  $\gamma_{\text{set}}$  and "set back" temperature difference  $\Delta T_{\text{set}}$ . When this option is used, the usual temperatures at which first- and second-stage heating are commanded are both reduced by  $(\gamma_{\text{set}})(\Delta T_{\text{set}})$ . Typically,  $\gamma_{\text{set}}$  is calculated by a TYPE 14 time-dependent function generator.

Hysteresis effects can be included in the model by supplying the optional "dead band" temperature difference  $\Delta T_{\text{db}}$ . A single value of  $\Delta T_{\text{db}}$ , if supplied, is applied to all three output control functions.

Parameter 1, NSTK, sets the number of oscillations permitted within a time step before the output state of the controller is "stuck". It is recommended that NSTK be set to 3 or 5.

### *Mathematical Description*

If hysteresis is not used, then  $\Delta T_{\text{db}}$  is set to zero. Similarly, when the set back option is not used,  $\gamma_{\text{set}}$  and  $\Delta T_{\text{set}}$  are zero. The heating and cooling on/off temperatures are set as follows:

*First heat source (solar):*

$$T'_{H1} = T_{H1} + \gamma_1 \cdot \Delta T_{\text{db}} - \gamma_{\text{set}} \cdot \Delta T_{\text{set}}. \quad (4.4)$$

*Second heat source (auxiliary):*

$$T'_{H2} = T_{H2} + \gamma_2 \cdot \Delta T_{\text{db}} - \gamma_{\text{set}} \cdot \Delta T_{\text{set}}. \quad (4.5)$$

*Cooling source:*

$$T'_C = T_C - \gamma_3 \cdot \Delta T_{\text{db}}. \quad (4.6)$$

When the first-stage source temperature  $T_h$  is greater than or equal to  $T_{\text{min}}$ , the first stage enabled function  $\gamma_e$  is set to 1 [36]. Otherwise,  $\gamma_e = 0$ . The controller then functions as shown in the following diagram (Figure 14).

## **4.2. Simulation Results**

The purpose of the simulation is to check the temperatures inside the greenhouse related to external climatic parameters and the type of construction of the greenhouse itself. The required energy for optimal climate conditioning is based on such calculation. These values in fact are calculated in order to maintain a steady temperature of 20 degrees which is considered suitable for the cultivation of a wide range of plant species.

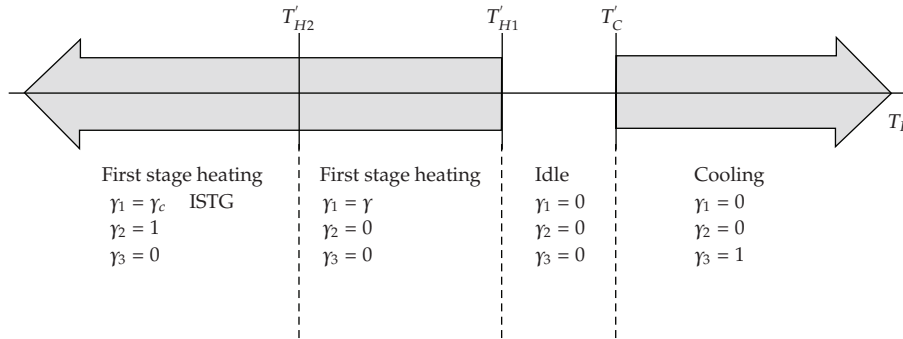

Figure 14: Controller Function.

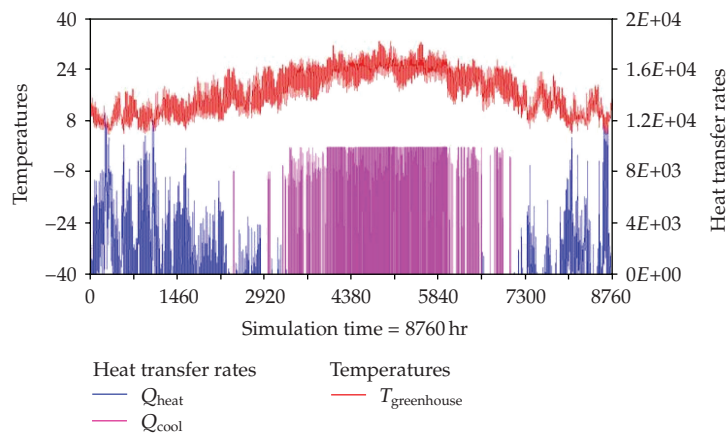

Figure 15: Chart greenhouse climate simulation.

The results are shown in the chart (Figure 15)

Where  $T_{\text{Greenhouse}}$  is inside room temperature,  $Q_{\text{Heat}}$  is required heating, the rate at which energy must be supplied to the device in order to heat the air to its outlet temperature, including the effects of losses and conversion inefficiencies,  $Q_{\text{Cool}}$  is rate of energy removed with the cooling system.

Moreover, the amount of heat to be made or removed by heating and cooling was connected to the printer to obtain the annual energy needs for heating and cooling:

$$\begin{aligned} Q_{\text{Heat}} &= 1,44E + 23 \text{ kJ/h,} \\ Q_{\text{Cool}} &= 2,25E + 23 \text{ kJ/h.} \end{aligned} \quad (4.7)$$

It can be seen that the energy demand for cooling is higher than that for heating [37]. This is due to the latitude where the greenhouse is located, characterized by very rigid winters and hot summers. The technology normally used in greenhouses for cooling, as shown in the chart above, is from an energy point of view very expensive.

The graphic represents a constant value of  $Q_{\text{Cool}}$  for the period July-August, even if the temperature inside the greenhouse undergoes changes.

An analysis of the chart is highlighting the need to rationalize the climate inside the greenhouse. This can be achieved

- (i) through the use of a more precise control systems, such as PID,
- (ii) through more sustainable air conditioning systems, the latter using heating and cooling floor system powered by a geothermal heat pump or conventional pump,
- (iii) or through improving the greenhouse insulation and ventilation systems.

## 5. Conclusions

The use of TRNSYS for simulating the implementation of greenhouses is rarely applied to the agricultural sector affecting national energy consumption. As reported in this paper the use of primary sources inside the greenhouse is important because such type of construction has poor insulation characteristics and air conditioning equipment.

The use of TRNSYS is necessary in order to obtain results from nonlinearity of the equations governing the laws of heat and control systems.

## Nomenclature

- $C_{pf}$ : fluid specific heat (kJ/kg·K)  
 $m_I$ : inlet fluid mass flow rate (kg/hr)  
 $m_o$ : outlet fluid mass flow rate (kg/hr)  
 $Q_{aux}$ : required heating rate including efficiency effects (kJ/hr)  
 $Q_{fluid}$ : rate of heat addition to fluid stream (kJ/hr)  
 $Q_{loss}$ : rate of thermal losses from heater to environment (kJ/hr)  
 $Q_{max}$ : maximum heating rate of heater (kJ/hr)  
 $T_{env}$ : temperature of heater surroundings for loss calculations (C)  
 $T_i$ : fluid inlet temperature (C)  
 $T_o$ : fluid outlet temperature (C)  
 $T_{set}$ : set temperature of heater internal thermostat (C)  
 $UA$ : overall loss coefficient between the heater and its surroundings during operation (kJ/hr)  
 $\gamma$ : (—) external control function which has values of 0 or 1  
 $\eta_{htr}$ : (0...1) efficiency of auxiliary heater.

## References

- [1] T. Kasuda and P. R. Archenbach, "Earth temperature and thermal diffusivity at selected stations in the United States," *ASHRAE Transactions*, vol. 71, part 1, 1965.
- [2] SOLMET, "Hourly solar radiation surface meteorological observations. Volume 2," Final Report TD-9724, National Climatic Data Center, Asheville, NC, USA, 1979.
- [3] C. M. Randall and M. E. Whitson, "Hourly insolation and meteorological data bases including improved direct insolation estimates," Aerospace Report ATR-78(7592)- 1, Aerospace Corporation, Los Angeles, Calif, USA, 1977.
- [4] J. A. Duffie and W. A. Beckman, *Solar Energy Thermal Processes*, Wiley, New York, NY, USA, 1974.
- [5] *ASHRAE Handbook of Fundamentals*, American Society of Heating, Refrigerating, and Air-Conditioning Engineers, 1972.
- [6] J. E. Braun and J. C. Mitchell, "Solar geometry for fixed and tracking surfaces," *Solar Energy*, vol. 31, no. 5, pp. 439–444, 1983.

- [7] D. T. Reindl, W. A. Beckman, and J. A. Duffie, "Diffuse fraction correlations," *Solar Energy*, vol. 45, no. 1, pp. 1–7, 1990.
- [8] D. T. Reindl, W. A. Beckman, and J. A. Duffie, "Evaluation of hourly tilted surface radiation models," *Solar Energy*, vol. 45, no. 1, pp. 9–17, 1990.
- [9] R. Perez, R. Stewart, R. Seals, and T. Guertin, "The development and verification of The Perez Diffuse Radiation Model," Sandia Report SAND88-7030, Sandia National Laboratories, Albuquerque, NM, USA, 1988.
- [10] K. M. Knight, S. A. Klein, and J. A. Duffie, "A methodology for the synthesis of hourly weather data," *Solar Energy*, vol. 46, no. 2, pp. 109–120, 1991.
- [11] K. M. Knight, *Development and validation of a weather data generation model*, M.S. thesis, Solar Energy Laboratory, University of Wisconsin, Madison, Wis, USA, 1988.
- [12] V. A. Graham, *Stochastic synthesis of the solar atmospheric transmittance*, Ph.D. thesis, University of Waterloo, 1985.
- [13] V. A. Graham, K. G. T. Hollands, and T. E. Unny, "Stochastic variation of hourly solar radiation over the day," in *Proceedings of the ISES Solar World Congress*, vol. 4, Hamburg, Germany, September 1987.
- [14] L. O. Degelman, "Monte Carlo simulation of solar radiation and dry bulb temperatures for air conditioning purposes," Report 70-9, Department of Architectural Engineering, The Pennsylvania State University, 1970, sponsored by the National Science Foundation under Grant No. GK-2204.
- [15] D. G. Erbs, S. A. Klein, and J. A. Duffie, "Estimation of the diffuse radiation fraction for hourly, daily and monthly-average global radiation," *Solar Energy*, vol. 28, no. 4, pp. 293–302, 1982.
- [16] D. G. Erbs, *Models and applications for weather statistics related to building heating and cooling loads*, Ph.D. thesis, University of Wisconsin, Madison, Wis, USA, 1984.
- [17] K. G. T. Hollands, L. J. D'Andrea, and I. D. Morrison, "Effect of random fluctuations in ambient air temperature on solar system performance," *Solar Energy*, vol. 42, no. 4, pp. 335–338, 1989.
- [18] R. A. Gansler, *Assessment of generated meteorological data for use in solar energy simulations*, M.S. thesis, Solar Energy Laboratory, University of Wisconsin, Madison, Wis, USA, 1993.
- [19] R. A. Gansler and S. A. Klein, "Assessment of the accuracy of generated meteorological data for use in solar energy simulation studies," in *Proceedings of ASME International Solar Energy Conference*, pp. 59–66, April 1993.
- [20] R. A. Gansler, S. A. Klein, and W. A. Beckman, "Investigation of minute solar radiation data," in *Proceedings of the Annual Conference of the American Solar Energy Society*, pp. 344–348, San Jose, Calif, USA, June 1994.
- [21] J. A. Duffie and W. A. Beckman, *Solar Engineering of Thermal Processes*, John Wiley & Sons, New York, NY, USA, 1991.
- [22] J. H. Eckstein, *Detailed modeling of photovoltaic components*, M.S. thesis, Solar Energy Laboratory, University of Wisconsin, Madison, Wis, USA, 1990.
- [23] B. Fry, *Simulation of grid-tied building integrated photovoltaic systems*, M.S. thesis, Solar Energy Laboratory, University of Wisconsin, Madison, Wis, USA, 1999.
- [24] D. L. King, J. A. Kratochvil, and W. E. Boyson, "Measuring the solar spectral and angle-of-incidence effects on photovoltaic modules and irradiance sensors," in *Proceedings of IEEE Photovoltaics Specialists Conference*, pp. 1113–1116, September-October 1997.
- [25] T. U. Townsend, *A method for estimating the long-term performance of direct-coupled photovoltaic systems*, M.S. thesis, University of Wisconsin, Madison, Wis, USA, 1989.
- [26] H. Laukamp, *Inverter for Photovoltaic Systems. User-written TRNSYS source code*, FraunhoferInstitute für Solare Energiesysteme, Freiburg im Breisgau, Germany, 1988.
- [27] Ø. Ulleberg, *Stand-alone power systems for the future: optimal design, operation & control of solar-hydrogen energy systems*, Ph.D. thesis, Norwegian University of Science and Technology, Trondheim, Norway, 1998.
- [28] D. B. Snyman and J. H. R. Enslin, "An experimental evaluation of MPPT converter topologies for PV installations," *Renewable Energy*, vol. 3, no. 8, pp. 841–848, 1993.
- [29] D. G. Stephenson and G. P. Mitalas, "Calculation of heat conduction transfer functions for multi-layer slabs," in *Proceedings of the ASHRAE Annual Meeting*, Washington, DC, USA, August 1971.
- [30] "Manuali dei controllori di temperatura Eurotherm".
- [31] "Manuali dei controllori di temperatura Oxford Instruments".
- [32] G. P. Mitalas and J. G. Arseneault, "FORTRAN IV program to calculate z-transfer functions for the calculation of transient heat transfer through walls and roofs," Report 5752842, NRC Institute for Research in Construction; National Research Council Canada, Ottawa, Canada, 2010.

- [33] J. E. Seem, *Modeling of heat in buildings*, Ph.D. thesis, Solar Energy Laboratory, University of Wisconsin, Madison, Wis, USA, 1987.
- [34] S. Holst, "Heating load of a building model in TRNSYS with different heating systems," ZAE Bayern, Abt. 4, TRNSYS-User Day, Stuttgart, Germany, 1993.
- [35] W. Feist, *Thermal Building Simulation. A Critical Review of Different Building Models*, C.F. Müller, Karlsruhe, Germany, 1994.
- [36] Th. Lechner, *Mathematical and Physical Fundamentals of the Transfer Function Method*, Institut für Thermodynamik und Wärmetechnik, Universität Stuttgart, 1992.
- [37] WINDOW 4.1, *PC Program for Analyzing Window Thermal Performance in Accordance with Standard NFRC Procedures*, Windows and Daylighting Group, Building Technologies Program, Energy and Environment Division, Lawrence Berkeley Laboratory, Berkeley, Calif, USA, 1994.