

Research Article

PV Maximum Power-Point Tracking by Using Artificial Neural Network

**Farzad Sedaghati,¹ Ali Nahavandi,¹
Mohammad Ali Badamchizadeh,¹ Sehraneh Ghaemi,¹
and Mehdi Abedinpour Fallah²**

¹ Faculty of Electrical and Computer Engineering, University of Tabriz, Tabriz 51666-16471, Iran

² Department of Mechanical and Industrial Engineering, Concordia University, Montreal, QC, Canada

Correspondence should be addressed to

Mohammad Ali Badamchizadeh, mbadamchi@tabrizu.ac.ir

Received 6 July 2011; Revised 6 November 2011; Accepted 30 November 2011

Academic Editor: Mohammad Younis

Copyright © 2012 Farzad Sedaghati et al. This is an open access article distributed under the Creative Commons Attribution License, which permits unrestricted use, distribution, and reproduction in any medium, provided the original work is properly cited.

In this paper, using artificial neural network (ANN) for tracking of maximum power point is discussed. Error back propagation method is used in order to train neural network. Neural network has advantages of fast and precisely tracking of maximum power point. In this method neural network is used to specify the reference voltage of maximum power point under different atmospheric conditions. By properly controlling of dc-dc boost converter, tracking of maximum power point is feasible. To verify theory analysis, simulation result is obtained by using MATLAB/SIMULINK.

1. Introduction

Recently, many countries of all over the world have paid a lot of their attention to the development of a renewable energy against depletion of fossil fuels in the coming future. The renewable energy means that the energy density is as high as fossil fuel or higher than that and the clean energy does not emit any polluted substances such as nitrogenous compounds, sulfate compounds, and dust. Hydrogen, as a future energy source, is thought as an alternative of fossil fuels in view of environment and energy security, because hydrogen itself is clean, sustainable, and emission-free. Hence, there are many ongoing active studies on the production and application of hydrogen in our society.

The main method for capturing the sun's energy is the use of photovoltaic. Photovoltaic (PV) utilizes the sun's photons or light to create electricity. PV technologies rely on the photoelectric effect first described by a French physicist Edmund Becquerel in 1839. Solar

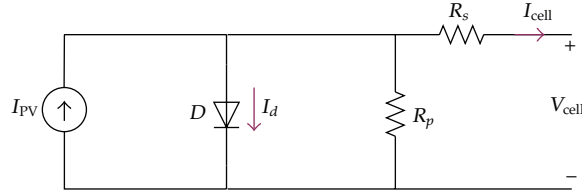

Figure 1: Equivalent circuit of PV model.

cells and modules using this PV effect are ideal energy generators that they require no fuel, generate no emissions, have no moving parts, can be made in any size or shape, and rely on a virtually limitless energy source, namely, the sun. The photoelectric effect occurs when a beam of ultraviolet light, composed of photons, strikes one part of a pair of negatively charged metal plates. This causes electrons to be “liberated” from the negatively charged plate. These free electrons are then attracted to the other plate by electrostatic forces. This flowing of electrons is an electrical current. This electron flow can be gathered in the form of direct current (DC). This DC can then be converted into alternating current (AC), which is the primary form of electrical current in electrical power systems that are most commonly used in buildings. PV devices take advantage of the fact that the energy in sunlight will free electrical charge carriers in certain materials when sunlight strikes those materials. This freeing of electrical charge makes it possible to capture light energy as electrical current [1].

In general, photovoltaic (PV) arrays convert sunlight into electricity. DC power generated depends on illumination of solar and environmental temperature which are variable. It is also varied according to the amount of load. Under uniform irradiance and temperature, a PV array exhibits a current-voltage characteristic with a unique point, called maximum power point, where the PV array produces maximum output power. In order to provide the maximum power for load, the maximum-power-point-tracking (MPPT) algorithm is necessary for PV array. Briefly, an MPPT algorithm controls converters to continuously detect the instantaneous maximum power of the PV array [2].

2. Photovoltaic Modelling

2.1. Ideal PV Cell Model

The equivalent circuit of the ideal PV cell is shown in Figure 1. The basic equation from the theory of semiconductors [3] that mathematically describes the I - V characteristic of the ideal PV cell is as follows:

$$I = I_{PV,cell} - I_{0,cell} \left[\exp\left(\frac{qV}{akT}\right) - 1 \right], \quad (2.1)$$

$$I_d = I_{0,cell} \left[\exp\left(\frac{qV}{akT}\right) - 1 \right], \quad (2.2)$$

where $I_{PV,cell}$ is the current generated by the incident light (it is directly proportional to the sun irradiation), I_d is the Shockley diode equation, $I_{0,cell}$ is the reverse saturation or leakage current of the diode, q is the electron charge ($1.60217646 \times 10^{-19}$ C), k is the Boltzmann

constant ($1.3806503 \times 10^{-23}$ J/K), T (in Kelvin) is the temperature of the p-n junction, and “ a ” is the diode ideality constant [4].

2.2. Modeling the PV Array

Equations (2.1) and (2.2) of the PV cell do not represent the V - I characteristic of a practical PV array. Practical arrays are composed of several connected PV cells and the observation of the characteristics at the terminals of the PV array requires the inclusion of additional parameters to the basic equation [3, 4]:

$$I = I_{PV} - I_0 \left[\exp\left(\frac{V + R_s I}{V_t a}\right) - 1 \right] - \frac{V + R_s I}{R_p}, \quad (2.3)$$

where I_{PV} and I_0 are the PV current and saturation currents, respectively, of the array and $V_t = N_s kT/q$ is the thermal voltage of the array with N_s cells connected in series. Cells connected in parallel increase the current and cells connected in series provide greater output voltages. If the array is composed of N_p parallel connections of cells, the PV and saturation currents may be expressed as $I_{PV} = N_p I_{PV,cell}$, $I_0 = N_p I_{0,cell}$. In (2.3), R_s is the equivalent series resistance of the array and R_p is the equivalent parallel resistance. Equation (2.3) describes the single-diode model presented in Figure 1 [4].

All PV array datasheets bring basically the following information: the nominal open-circuit voltage ($V_{oc,n}$), the nominal short-circuit current ($I_{sc,n}$), the voltage at the MPP (V_{mpp}), the current at the MPP (I_{mpp}), the open-circuit voltage/temperature coefficient (K_V), the short-circuit current/temperature coefficient (K_I), and the maximum experimental peak output power (P_{max}). This information is always provided with reference to the nominal condition or standard test conditions (STCs) of temperature and solar irradiation. Some manufacturers provide I - V curves for several irradiation and temperature conditions. These curves make easier the adjustment and the validation of the desired mathematical I - V equation. Basically, this is all the information one can get from datasheet of PV arrays [4].

Electric generators are generally classified as current or voltage sources. The practical PV device presents hybrid behavior, which may be of current or voltage source depending on the operating point. The practical PV device has a series resistance R_s whose influence is stronger when the device operates in the voltage source region and a parallel resistance R_p with stronger influence in the current source region of operation. The R_s resistance is the sum of several structural resistances of the device. R_s basically depends on the contact resistance of the metal base with the p semiconductor layer, the resistances of the p and n bodies, the contact resistance of the n layer with the top metal grid, and the resistance of the grid [5]. The R_p resistance exists mainly due to the leakage current of the p-n junction and depends on the fabrication method of the PV cell. The value of R_p is generally high and some authors neglect this resistance to simplify the model. The value of R_s is very low, and sometimes this parameter is neglected too.

The V - I characteristic of the PV array, shown in Figure 2, depends on the internal characteristics of the device (R_s , R_p) and on external influences such as irradiation level and temperature.

The amount of incident light directly affects the generation of charge carriers and, consequently, the current generated by the device. The light-generated current (I_{PV}) of the

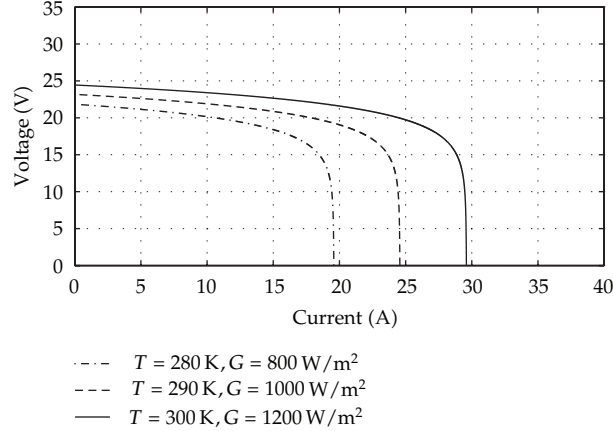

Figure 2: V - I characteristic of PV.

elementary cells, without the influence of the series and parallel resistances, is difficult to determine. Datasheets only inform the nominal short-circuit current ($I_{sc,n}$), which is the maximum current available at the terminals of the practical device. The assumption $I_{sc} \approx I_{PV}$ is generally used in the modeling of PV devices because in practical devices the series resistance is low and the parallel resistance is high. The light-generated current of the PV cell depends linearly on the solar irradiation and is also influenced by the temperature according to the following equation (2.4), [2, 4, 6–8]

$$I_{PV} = (I_{PV,n} + K_I \Delta T) \frac{G}{G_n}, \quad (2.4)$$

where $I_{PV,n}$ (in amperes) is the light-generated current at the nominal condition (usually 25°C and 1000 W/m^2), $\Delta T = T - T_n$ (T and T_n being the actual and nominal temperatures (in Kelvin), resp.), G (watt per square meter) is the irradiation on the device surface, and G_n is the nominal irradiation. $V_{t,n}$ is the thermal voltage of N_s series-connected cells at the nominal temperature T_n .

The saturation current I_0 of the PV cells that compose the device depend on the saturation current density of the semiconductor (J_0 , generally given in $[\text{A}/\text{cm}^2]$) and on the effective area of the cells. The current density J_0 depends on the intrinsic characteristics of the PV cell, which depend on several physical parameters such as the coefficient of diffusion of electrons in the semiconductor, the lifetime of minority carriers, and the intrinsic carrier density [9]. In this paper the diode saturation current I_0 is approximated by the fixed value (6 mA).

The value of the diode constant “ a ” may be arbitrarily chosen. Many authors discuss ways to estimate the correct value of this constant. Usually, $1 \leq a \leq 1.5$ and the choice depends on other parameters of the I - V model. Some values for “ a ” are found in [6] based on empirical analyses. Because “ a ” expresses the degree of ideality of the diode and it is totally empirical, any initial value of “ a ” can be chosen in order to adjust the model. The value of “ a ” can be later modified in order to improve the model fitting, if necessary. This constant

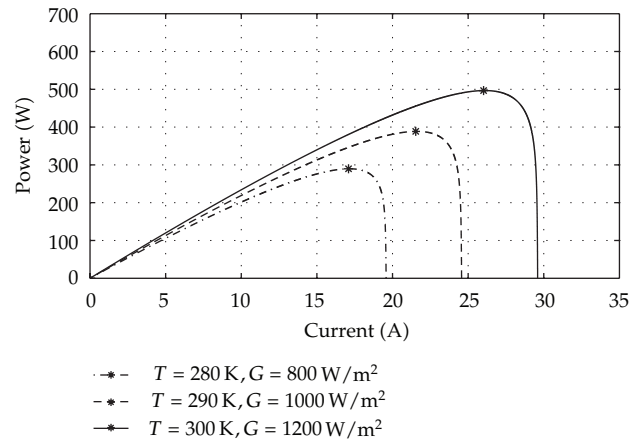

Figure 3: P - I characteristic of PV.

affects the curvature of the V - I curve and varying a can slightly improve the model accuracy [4].

3. Maximum Power-Point Tracking

3.1. Maximum power-point tracking methods

By change of environment temperature and irradiance, the maximum power is variable (Figure 3). Since the maximum available energy of solar arrays continuously changes with the atmospheric conditions, a real-time maximum power-point tracker is the indispensable part of the PV system. Proposed maximum power point tracking (MPPT) schemes in the technical literature [10] can be divided into three different categories [11].

- (1) Direct methods.
- (2) Artificial intelligence methods.
- (3) Indirect methods.

In the direct methods, which are also known as true seeking methods, the MPP is searched by continuously perturbing the operating point of the PV array. Under this category, Perturb and Observe (P&O) [12], Hill Climbing (HC) [13], and Incremental Conductance (INC) [14] schemes are widely applied in PV systems. P&O scheme involves perturbing the operation voltage of the PV array to reach the MPP. Analogous to P&O scheme, hill climbing method perturbs the duty cycle of the dc-dc interface converter. Simplicity is the main feature of these methods; however, intrinsic steady state oscillation limits these methods to low-power applications. Reduced steady state oscillation is possible with the incremental conductance method, which is based on the fact that the slope of the power versus voltage is zero at the MPP. Artificial intelligence and indirect methods have been proposed to improve the dynamic performance of MPP tracking. Concentrating on nonlinear characteristics of the PV arrays, the artificial intelligence methods provide a fast, and yet, computationally demanding solution for the MPPT problem.

The indirect methods are based on extracting the MPP of the array from its output characteristics. Fractional open-circuit voltage (OCV) [15] and short-circuit current (SCC) [16] schemes provide a simple and effective way to obtain the MPP.

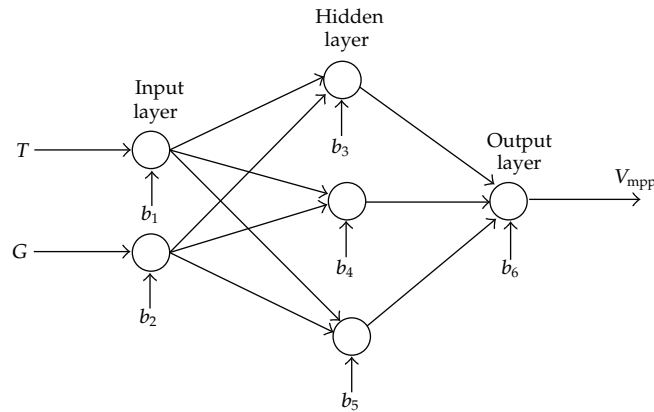

Figure 4: Neural network structure.

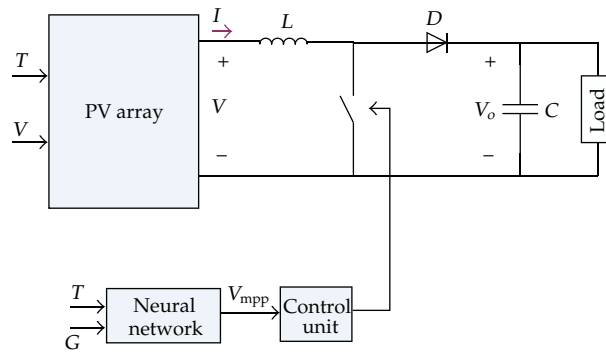

Figure 5: DC-DC chopper includes PV as a input and its control units.

3.2. MPPT by Using Neural Network

In this paper for tracking maximum power point, an artificial neural network is used. A three-layer neural network is used to reach MPP, which is shown in Figure 4.

Temperature (T) and irradiance (G) are two input variables and voltage of MPP (V_{mpp}) is the output variable of ANN. It is necessary to obtain some data as input and output variable to train the neural network. Consequently, weights of neurons in different layers are acquired. PV model programming in MATLAB is used in order to obtain data. There are several methods to train ANN. In this paper error back propagation method is used to train the ANN.

After training the ANN and specification of neuron weights, for any T and G as inputs of ANN, output of ANN is the V_{mpp} . Now, current of maximum power point (I_{mpp}) can be obtained by using V - I characteristic of the modeled PV. Consequently, maximum power (P_{max}) is reached by multiplying V_{mpp} and I_{mpp} .

Figure 5 shows PV and maximum power point tracker system, which is composed of a dc-dc boost converter and neural network-based control unit. In every moment to control

Table 1: Parameters of the KC200GT solar array at 25°C, A.M1.5, 1000 W/m².

Parameter	Value
I_{sc}	8.21 A
V_{oc}	32.9 V
I_0	6 mA
I_{PV}	8.21 A
a	1.3
R_p	415.405 Ω
R_s	0.221 Ω
N_s	54
N_p	3
K_v	-0.123 V/K
K_I	0.0032 A/K
$L_{chopper}$	570 μ H
$C_{chopper}$	300 μ F

chopper with specified V_{mpp} and I_{mpp} duty cycle of chopper is obtained by the following equation:

$$D = 1 - \sqrt{\frac{V_{mpp}}{I_{mpp}} \times \frac{I_{out}}{V_{out}}}, \quad (3.1)$$

4. Simulation Results

To verify theoretical analysis mentioned in previous sections, a stand-alone PV system which is connected to a boost dc-dc converter is simulated by using MATLAB/SIMULINK. The simulated model characteristics are as shown in Table 1.

First, the neural network model is trained by series of data containing temperature, irradiance, and voltage of maximum power point. Error back propagation method is used to train ANN. After getting neurons weights, the neural network model is simulated by using MATLAB/SIMULINK and jointed to the control unit. Now, for any T and G as inputs of ANN, the output is related to $V_{ref,mpp}$ automatically.

Simulation is done in three states with three different temperatures and irradiances. Three different temperatures and irradiances, which is applied in simulation, are shown in Figure 6. The neural network output which is reference voltage of maximum power point ($V_{ref,mpp}$) for these three pairs of T and G is shown in Figure 7(a). By specification of $V_{ref,mpp}$ reference current of power point ($I_{ref,mpp}$) is obtained from control unit (Figure 7(b)).

By applying $V_{ref,mpp}$ and $I_{ref,mpp}$ to the chopper control unit, switching pulses are generated in such a way that the output voltage and current of PV track the $V_{ref,mpp}$ and $I_{ref,mpp}$. In Figure 8 output voltage and current of PV are shown. It is obvious from this figure that output voltage and current of PV are tracking $V_{ref,mpp}$ and $I_{ref,mpp}$. By comparison of reference of maximum power and power which is drawn from PV, it can be found that the maximum power reference is tracked (Figure 9). As there figures show, in voltage, current, and consequently maximum power-point tracking, control system has a good dynamic performance.

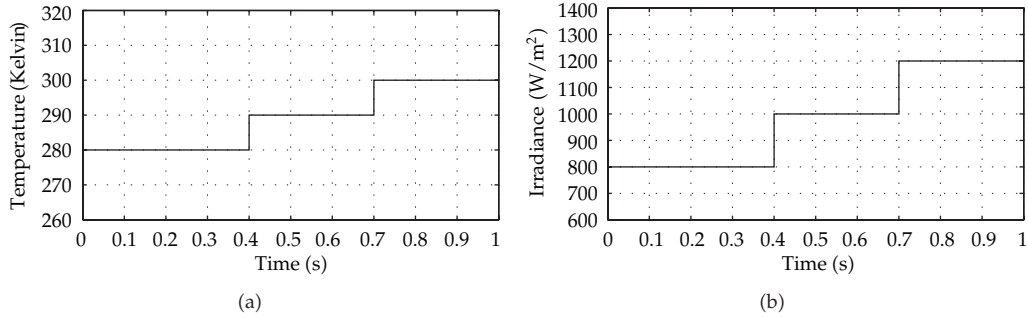

Figure 6: (a) Three different temperatures, (b) Irradiances applied to simulation results.

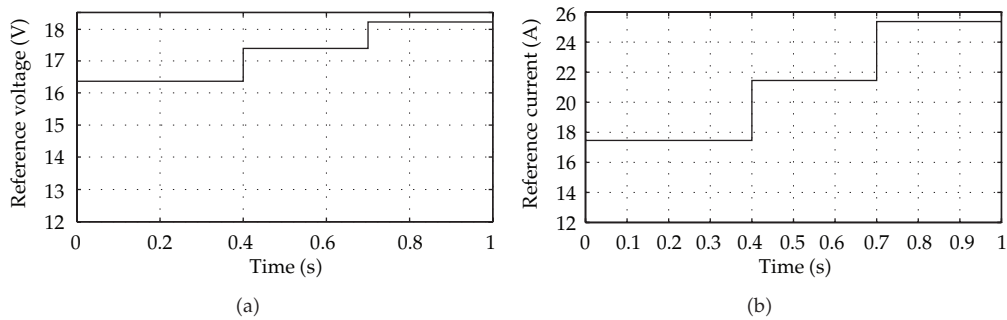

Figure 7: (a) Reference voltage of maximum power point generated by ANN, (b) Reference current of maximum power point.

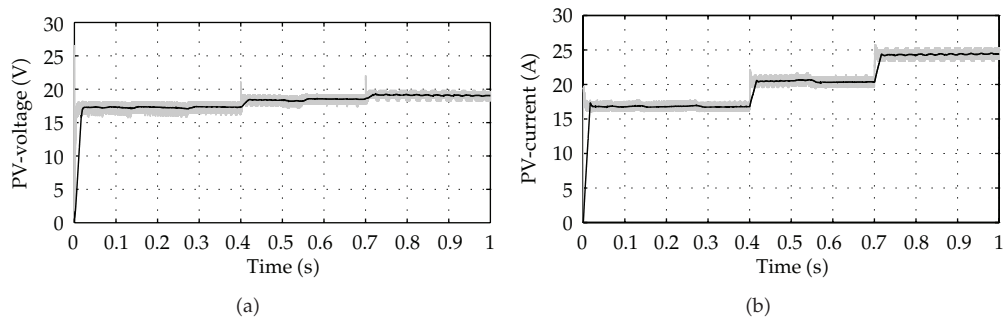

Figure 8: (a) Output voltage of PV, (b) Output current of PV.

Figure 10 shows output voltage of chopper which can be applied to charge a battery or input voltage of a regulator converter.

5. Conclusion

This paper discusses neural network-based MMPT. Under any variation in atmospheric conditions, by using neural network, point of maximum power is specified fast and precisely. Another advantage of the neural network in PV maximum power-point tracking is its better

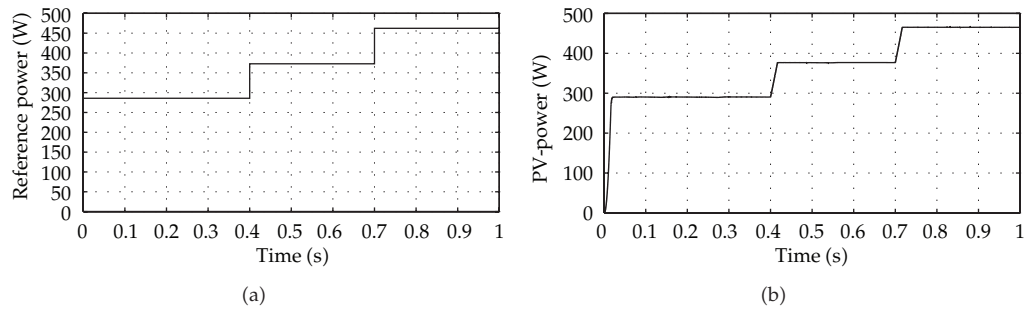

Figure 9: (a) Reference maximum power, (b) drawn power from PV.

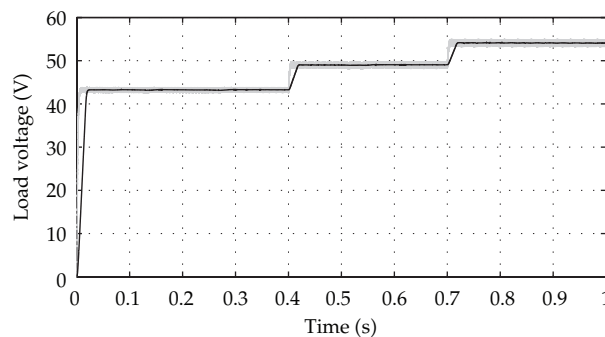

Figure 10: Output voltage of chopper.

dynamic performance in comparison with the other methods. Also the maximum power point is tracked by dc-dc boost chopper. So the maximum power solar energy and the best efficiency are obtained.

References

- [1] S. J. Lee, H. Y. Park, G. H. Kim et al., "The experimental analysis of the gridconnected PV system applied by POS MPPT," in *Proceedings of the International Conference on Electrical Machines and Systems (ICEMS '07)*, pp. 1786–1791, Seoul, Korea, October 2007.
- [2] H. H. Lee, L. M. Phuong, P. Q. Dzung, N. T. Dan Vu, and L. D. Khoa, "The new maximum power point tracking algorithm using ANN-based solar PV systems," in *Proceedings of the IEEE Region 10 Conference (TENCON '10)*, pp. 2179–2184, Fukuoka, Japan, November 2010.
- [3] H. S. Rauschenbach, *Solar Cell Array Design Handbook*, Van Nostrand Reinhold, New York, NY, USA, 1980.
- [4] M. G. Villalva, J. R. Gazoli, and E. R. Filho, "Comprehensive approach to modeling and simulation of photovoltaic arrays," *IEEE Transactions on Power Electronics*, vol. 24, no. 5, pp. 1198–1208, 2009.
- [5] F. Lasnier and T. G. Ang, *Photovoltaic Engineering Handbook*, Adam Hilger, New York, NY, USA, 1990.
- [6] W. De Soto, S. A. Klein, and W. A. Beckman, "Improvement and validation of a model for photovoltaic array performance," *Solar Energy*, vol. 80, no. 1, pp. 78–88, 2006.
- [7] Q. Kou, S. A. Klein, and W. A. Beckman, "A method for estimating the long-term performance of direct-coupled PV pumping systems," *Solar Energy*, vol. 64, no. 1–3, pp. 33–40, 1998.
- [8] A. Driesse, S. Harrison, and P. Jain, "Evaluating the effectiveness of maximum power point tracking methods in photovoltaic power systems using array performance models," in *Proceedings of the IEEE 38th Annual Power Electronics Specialists Conference (PESC '07)*, pp. 145–151, Orlando, Fla, USA, June 2007.

- [9] K. Nishioka, N. Sakitani, Y. Uraoka, and T. Fuyuki, "Analysis of multicrystalline silicon solar cells by modified 3-diode equivalent circuit model taking leakage current through periphery into consideration," *Solar Energy Materials and Solar Cells*, vol. 91, no. 13, pp. 1222–1227, 2007.
- [10] T. Esumi and P. L. Chapman, "Comparison of photovoltaic array maximum power point tracking techniques," *IEEE Transactions on Energy Conversion*, vol. 22, no. 2, pp. 439–449, 2007.
- [11] V. Salas, E. Olías, A. Barrado, and A. Lázaro, "Review of the maximum power point tracking algorithms for stand-alone photovoltaic systems," *Solar Energy Materials and Solar Cells*, vol. 90, no. 11, pp. 1555–1578, 2006.
- [12] O. Wasynczuk, "Dynamic behavior of a class of photovoltaic power systems," *IEEE Transactions on Power Apparatus and Systems*, vol. 102, no. 9, pp. 3031–3037, 1983.
- [13] E. Koutroulis, K. Kalaitzakis, and N. C. Voulgaris, "Development of a microcontroller-based, photovoltaic maximum power point tracking control system," *IEEE Transactions on Power Electronics*, vol. 16, no. 1, pp. 46–54, 2001.
- [14] K. H. Hussein, I. Muta, T. Hoshino, and M. Osakada, "Maximum photovoltaic power tracking: an algorithm for rapidly changing atmospheric conditions," *IEE Proceedings: Generation, Transmission and Distribution*, vol. 142, no. 1, pp. 59–64, 1995.
- [15] J. J. Schoeman and J. D. van Wyk, "A simplified maximal power controller for terrestrial photovoltaic panel arrays," in *Proceedings of the IEEE 13th Annual Power Electronics Specialists Conference (PESC '82)*, pp. 361–367, 1982.
- [16] M. A. S. Masoum, H. Dehbonei, and E. F. Fuchs, "Theoretical and experimental analyses of photovoltaic systems with voltage- and current-based maximum power-point tracking," *IEEE Transactions on Energy Conversion*, vol. 17, no. 4, pp. 514–522, 2002.



Hindawi

Submit your manuscripts at
<http://www.hindawi.com>

