

Geometry & Topology
Volume 6 (2002) 425{494
Published: 23 October 2002

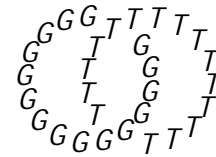

Cappell-Shaneson's 4-dimensional s -cobordism

Selman Akbulut

*Department of Mathematics
Michigan State University
MI, 48824, USA*

Email: akbulut@math.msu.edu

Abstract

In 1987 S Cappell and J Shaneson constructed an s -cobordism H from the quaternionic 3-manifold Q to itself, and asked whether H or any of its covers are trivial product cobordism? In this paper we study H , and in particular show that its 8-fold cover is the product cobordism from S^3 to itself. We reduce the triviality of H to a question about the 3-twist spun trefoil knot in S^4 , and also relate this to a question about a Fintushel-Stern knot surgery.

AMS Classification numbers Primary: 57R55, 57R65

Secondary: 57R17, 57M50

Keywords: s -cobordism, quaternionic space

Proposed: Robion Kirby
Seconded: Ronald Stern, Yasha Eliashberg

Received: 4 September 2002
Accepted: 2 October 2002

0 Introduction

Let $Q^3 = S^3/\mathbf{Q}_8$ be the quaternionic 3-manifold, obtained as the quotient of the 3-sphere by the free action of the quaternionic group \mathbf{Q}_8 of order eight, which can be presented by $\mathbf{Q}_8 = \langle i, j, k \mid i^2 = j^2 = k^2 = -1; ij = k; jk = i; ki = ji \rangle$. Also Q is the 2-fold branched covering space of S^3 branched over the three Hopf circles; combining this with the Hopf map $S^3 \rightarrow S^2$ one sees that Q is a Seifert Fibered space with three singular fibers. Q is also the 3-fold branched covering space of S^3 branched over the trefoil knot. Q can also be identified with the boundaries of the 4-manifolds of Figure 1 (one can easily check that the above three definitions are equivalent to this one by drawing framed link pictures). The second manifold W of Figure 1, consisting of a 1- and 2-handle pair, is a Stein surface by [9]. It is easily seen that W is a disk bundle over $\mathbf{R}P^2$ obtained as the tubular neighborhood of an imbedded $\mathbf{R}P^2$ in S^4 . The complement of this imbedding is also a copy of W , decomposing $S^4 = W \natural W$.

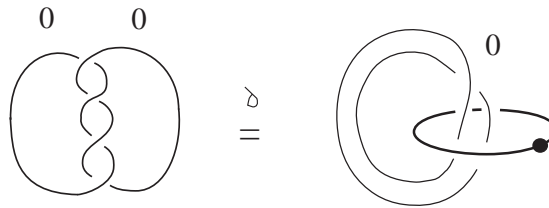

Figure 1

In [6], [7] Cappell and Shaneson constructed an s -cobordism H from Q to itself as follows: Q is the union of an I -bundle over a Klein bottle \mathbf{K} and the solid torus $S^1 \times D^2$, glued along their boundaries. Let N be the D^2 -bundle over \mathbf{K} obtained as the open tubular neighborhood of $\mathbf{K} \times \{0\}$ in the interior of $Q \times [0; 1]$. Then they constructed a certain punctured torus bundle M over \mathbf{K} , with $\partial M = \partial N$, and replaced N with M :

$$H = M \natural (Q \times [0; 1] - \text{interior } N)$$

They asked whether H or any of its covers are trivial product cobordisms? Evidently the 2-fold cover of H is an s -cobordism \mathcal{H} from the lens space $L(4; 1)$ to itself, and the further 4-fold cyclic cover $\hat{\mathcal{H}}$ of \mathcal{H} gives an s -cobordism from S^3 to itself. For the past 15 years the hope was that this universal cover $\hat{\mathcal{H}}$ might be a non-standard s -cobordism, inducing a fake smooth structure on S^4 . In this paper among other things we will prove that this is not the case by demonstrating the following smooth identification:

Theorem 1 $\hat{H} = S^3 \times [0; 1]$

We will first describe a handlebody picture of H (Figure 47). Let Q be the two boundary components of H each of which is homeomorphic to Q :

$$\partial H = Q_- \cup Q_+$$

We can cap either ends of H with W , by taking the union with W along $Q = \partial W$:

$$W = H \cup_Q W$$

There is more than one way of capping H since Q has nontrivial self diffeomorphisms, but it turns out from the construction that there is a 'natural' way of capping. The reason for bringing the rational ball W into the picture while studying Q is that philosophically the relation of W to Q is similar to the relation of B^4 to S^3 . Unable to prove that H itself is a product cobordism, we prove the next best thing:

Theorem 2 $W_- = W$

Unfortunately we are not able to find a similar proof for W_+ . This is because the handlebody picture of H is highly non-symmetric (with respect to its two ends) which prevents us adapting the above theorem to W_+ . Even though, there is a way of capping H with W_+ which gives back the standard W , it does not correspond to our 'natural' way of capping (see the last paragraph of Section 1).

The story for W_+ evolves in a completely different way: Let \hat{W} and \hat{W}_+ denote the 2-fold covers of W and W_+ respectively (note that $\pi_1(W) = \mathbf{Z}_2$ and \hat{W} is the Euler class -4 disk bundle over S^2). We will manage to prove \hat{W}_+ is standard, by first showing that it splits as $W \# S^4$, where $\#$ is a certain homotopy 4-sphere, and then by proving $\#$ is in fact diffeomorphic to S^4 .

Theorem 3 $\hat{W}_+ = \hat{W}$

It turns out that the homotopy sphere $\#$ is obtained from S^4 by the *Gluck construction* along a certain remarkable 2-knot $A \subset S^4$ (ie, there is an imbedding $F: S^2 \hookrightarrow S^4$ with $F(S^2) = A$). Furthermore A is the fibered knot in S^4 with fiber consisting of the punctured quaternionic 3-manifold Q_0 , with monodromy $\tau: Q_0 \rightarrow Q_0$ coming from the restriction of the order 3 diffeomorphism of Q , which cyclically permutes the three singular fibers of Q (as Seifert Fibered space). Recall that, in [15] the Mapping Class group $\pi_0(\text{Diff}(Q))$ of

Q was computed to be S_3 , the symmetric group on three letters (transpositions correspond to the diffeomorphisms pairwise permuting the three singular fibers). In fact in a peculiar way this 2-knot A completely determines the cobordism H (this is explained in the next paragraph). Then Theorem 3 follows by showing that the Gluck construction to S^4 along A yields S^4 , and Theorem 1 follows by showing $\hat{H} = (S^3 \times [0;1]) \# S^4$.

Figure 77 describes a nice handlebody description of W_+ . One remarkable thing about this figure is that it explicitly demonstrates H as the complement of the imbedded $W \subset W_+$ (we refer this as the *vertical handlebody of H*). Note that W is clearly visible in Figure 77. It turns out that W_+ is obtained by attaching a 2-handle to the complement of the tubular neighborhood of A in S^4 and the 2-handle H_1 is attached the simplest possible way along the twice the meridional circle of A ! (Figures 77 and 82). Equivalently, W_+ is the complement of the tubular neighborhood of of an knotted \mathbf{RP}^2 in S^4 , which is obtained from the standardly imbedded \mathbf{RP}^2 by connected summing operation $\mathbf{RP}^2 \# A \subset S^4 \# S^4 = S^4$.

Put another way, if $f: B^2 \hookrightarrow B^4$ is the proper imbedding (with standard boundary) induced from $A \subset S^4$ by deleting a small ball B^4 from S^4 , then (up to 3-handles) W_+ is obtained by removing a tubular neighborhood of $f(B^2)$ from B^4 and attaching a 2-handle along the circle in S^3 , which links the unknot $f(\partial B^2)$ twice as in Figure 1. Note that in Figure 1 $f(\partial B^2)$ corresponds to the the circle with dot. So W_+ is obtained by removing a tubular neighborhood of a properly imbedded knotted 2-disc from $S^2 \times B^2$, while W is obtained by removing a tubular neighborhood of the unknotted 2-disc with the same boundary. This is very similar to the structure of the fake shtail of [1]. Also, it turns out that A is the 3-twist spun of the trefoil knot, and it turns out that W_+ is obtained from W by the Fintushel-Stern knot surgery operation [8].

The reason why we have not been able to decide whether H itself is the product cobordism is that we have not been able to put the handlebody of H in a suitable form to be able to apply our old reliable "upside-down turning trick" (eg [2], [5]), which is used in our proofs. This might yet happen, but until then potentially H could be a fake s-cobordism.

Acknowledgements We would like to thank R Kirby for giving us constant encouragement and being a friendly ear during development of this paper, and also U Meierfrankenfeld for giving us generous help with group theory which led us to prove the crucial braiding theorem. We also want to thank IAS for providing a nice environment where the bulk of this work was done. The author was partially supported by NSF grant DMS 9971440 and by IAS.

1 Handlebody of $Q [0; 1]$

Let $I = [0; 1]$. We draw Q / I by using the technique of [1]. Q is the obtained by surgering S^3 along a link L of two components linking each other twice (the first picture of Figure 1), hence Q / I is obtained by attaching two 2-handles to $(S^3 - L) / I$.

Note that, since 3 and 4-handles of any 4-manifold are attached in a canonical way, we only need to visualize the 1 and 2-handles of Q / I . Hence it suffices to visualize $(B^3 - L_0) / I$, where L_0 is a pair of properly imbedded arcs linking each other twice, plus the two 2-handles as shown in Figure 2 (the rest are 3-handles).

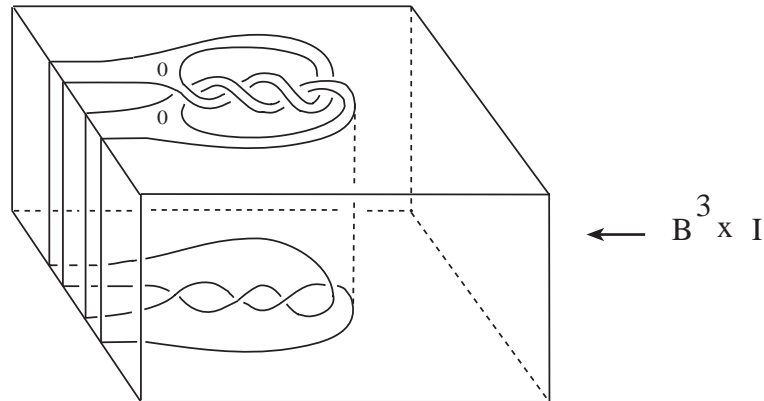

Figure 2

Clearly Figure 2 is obtained first by removing the two obvious 2-disks from $B^4 = B^3 / I$ which $L \# (-L)$ bounds, and then by attaching two 2-handles (here $-L$ denotes the the mirror image of L). This gives the first picture of Figure 3. In Figure 3 each circle with dot denotes a 1-handle (ie, the obvious disks it bounds is removed from B^4). The second picture of Figure 3 is diffeomorphic to the first one, it is obtained by sliding a 2-handle over a 1-handle as indicated in the figure. By an isotopy of Figure 3 (pulling 1-handles apart) we obtain the first picture of Figure 4, which is the same as the second picture, where the 1-handles are denoted by a different notation (as pair of attaching balls). Hence Figure 4 gives Q / I .

For a future reference the linking loops $a; b$ of the 1-handles of the first picture of Figure 4 are indicated in the second picture of Figure 4. Notice that we can easily see an imbedded copy of the Klein bottle \mathbf{K} in Q / I as follows: The first

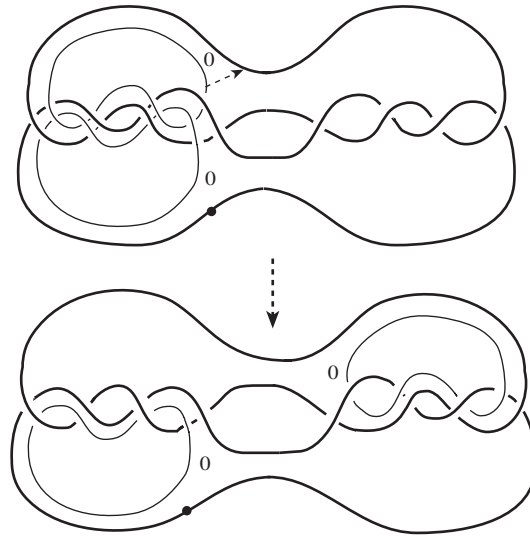

Figure 3

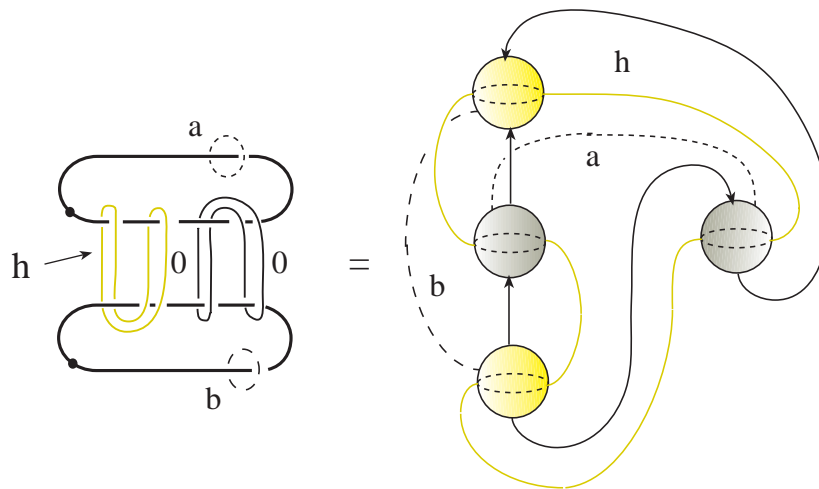

Figure 4

picture of Figure 5 denotes \mathbf{K} (a square with the opposite sides identified as indicated). By thickening this to a four dimensional handlebody we obtain the second picture of Figure 5 which is a D^2 -bundle N over \mathbf{K} (the orientation reversing 1-handle is indicated by putting "tilde" in the corresponding balls). The third and the fourth pictures of Figure 5 are also N , drawn in different

1-handle notations.

Clearly the handlebody of Figure 5 sits in Figure 4, demonstrating an imbedding of the disk bundle N over the Klein bottle into $Q \setminus I$. For the purpose of future references, we indicated where the linking circle b of the 1-handle lies in the various handlebody pictures of N in Figure 5.

Finally in Figure 6 we draw a very useful 'vertical' picture of $Q \setminus I$ as a product cobordism starting from the boundary of W to itself like a collar. Though this is a seemingly a trivial handlebody of H it will be useful in a later construction. Later, we will first construct a handlebody picture of the 5-cobordism H from Q to itself, and then view it like a collar sitting on the boundary of W , ie, as a vertical picture of the cobordism starting from the boundary of a W to Q . Note that N is clearly visible in Figure 6, which is an alternative handlebody of W (N is lying in the collar of its boundary). Also notice that the operation Figure 4 \rightarrow Figure 6, ie, capping one end of $Q \setminus I$ by W , corresponds to attaching a 2-handle to Figure 4 along the loop b . Similarly capping the other end of $Q \setminus I$ by $-W$ corresponds to attaching a 2-handle to it along the loop a . Note that Figure 4 can also indicate the handlebody of $Q_0 \setminus I$, where Q_0 is the punctured Q (in this case we simply ignore the 3-handle).

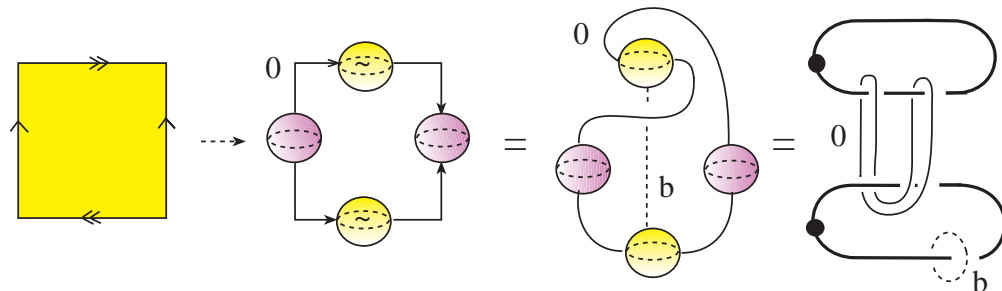

Figure 5

2 Construction of H

Here we will briefly recall the Cappell-Shaneson construction [6], and indicate why H is an 5-cobordism: Let T_0 denote the punctured 2-torus. M is constructed by gluing together two T_0 -bundles over Mobius bands given with the monodromies:

$$A = \begin{pmatrix} 0 & 1 \\ 1 & 1 \end{pmatrix} \quad B = \begin{pmatrix} 0 & -1 \\ -1 & -1 \end{pmatrix}$$

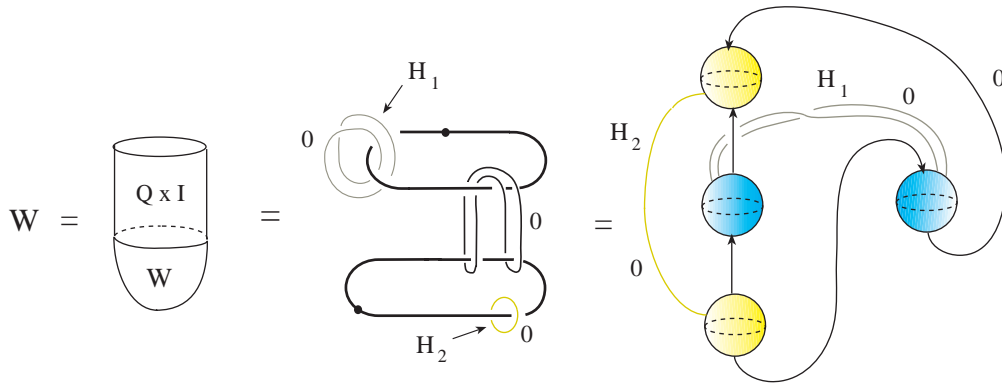

Figure 6

Since $A^2 = B^2$ these bundles agree over the boundaries of the Mobius bands, hence they give a bundle M over the the union of the two Mobius bands along their boundaries (which is the Klein bottle). By using the handle description of \mathbf{K} given by the second picture of Figure 7, we see that M is the T_0 {bundle over \mathbf{K} , de ned by the monodromies

$$A = \begin{pmatrix} 0 & 1 \\ 1 & 1 \end{pmatrix} \quad C = B^{-1}A = \begin{pmatrix} -1 & 0 \\ 0 & -1 \end{pmatrix}$$

Let $t; x$ and s to be the standard generators of the fundamental groups of

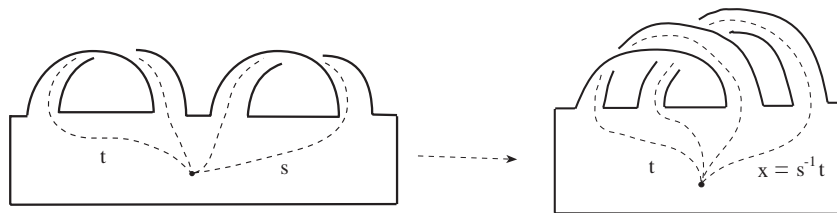

Figure 7

\mathbf{K} and T_0 respectively , then:

$$\pi_1(M) = \langle t; x; s \mid \begin{aligned} t t^{-1} &= 1, & s s^{-1} &= 1, \\ x x^{-1} &= 1, & t x^{-1} &= x^{-1} \end{aligned} \rangle$$

So $x^2 x^{-2} = x^{-1} x^{-1} = 1$, $x^2 x^{-2} = x^{-1} x^{-1} = 1$) $x^2 = x^2$ and $x^2 = x^2$.

Recall that $H = M \wedge (Q \times [0; 1] - \text{interior } N)$, which is the same as $M \wedge h$, where h is a 2-handle (Figure 4). Let us briefly indicated why the boundary inclusion induces an isomorphism $\pi_1(Q) \cong \pi_1(H)$: By Van-Kampen theorem attaching the 2-handle h introduces the relation $xtx^{-1} = t^{-1}$ to $\pi_1(M)$; which together with $tx^{-1} = x^{-1}$ gives $t^{-2} = x^2$. Therefore in $\pi_1(H)$ the relations $t^2 t^{-2} = t t^{-1}$, and $t^2 t^{-2} = t t^{-1}$ become: $1 = t t^{-1}$, and $1 = t t^{-1}$. Then by substituting in π_1 , and by using the fact that π_1 commutes with t^{-2} , we get $\pi_1 = 1$ and hence $\pi_1 = 1$. Hence the boundary inclusions $\pi_1(Q) \cong \pi_1(H)$ induce isomorphisms. In fact H is an 5-cobordism from Q to itself. From now on let \hat{M} denote the corresponding T^2 -bundle over \mathbf{K} induced by M by the obvious way, clearly:

$$M = \hat{M} - N$$

3 Handlebody of \hat{M}

From the last section we see that M is obtained by first taking the T^2 -bundle $T^2 \times_{-I} S^1 \rightarrow S^1$ with monodromy $-I$, and crossing it by I , and by identifying the ends of this 4-manifold with the monodromy:

$$\begin{matrix} \circ & & \uparrow \\ \cong & \begin{matrix} 0 & 1 & 0 \\ 1 & 1 & 0 \\ 0 & 0 & -1 \end{matrix} & \cong \\ \cong & \text{---} & \cong \end{matrix}$$

This is indicated in Figure 8 (here we are viewing \mathbf{K} as the handlebody of the second picture of Figure 7).

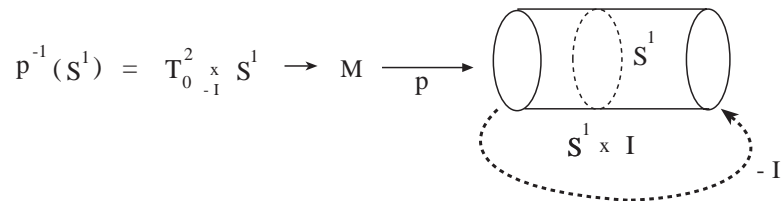

Figure 8

Drawing the handlebody of $M = (T^2 \times_{-I} S^1) \cup S^1$ directly will present a difficulty in later steps, instead we will first draw the corresponding larger T^2 -bundle

$$\hat{M} = (T^2 \times_{-I} S^1) \cup S^1$$

then remove a copy of N from it. $T^2 \times_{-I} S^1$ is obtained by identifying the two ends of $T^2 \times I$ with $-I$. Figure 9 describes a two equivalent pictures of

the Heegaard handlebody of $T^2 \cup S^1$. The pair of ‘tilde’ disks describe a twisted 1-handle (due to identification $(x; y) \sim (-x; -y)$). If need be, after rotating the attaching map of the the twisted 1-handle we can turn it to a regular 1-handle as indicated by the second picture of Figure 9.

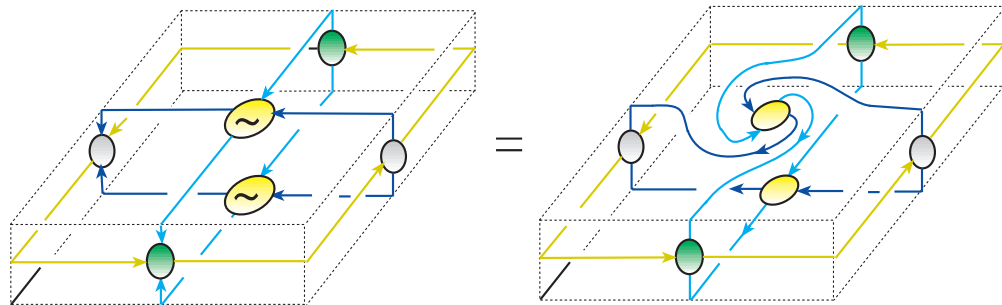

Figure 9

Now we will draw $\hat{M} = (T^2 \cup S^1) \cup S^1$ by using the technique introduced in [4]: We first thicken the handlebody $T^2 \cup S^1$ of Figure 9 to the 4-manifold $T^2 \cup S^1 \cup I$ (the first picture of Figure 10). Then isotop $\nu : T^2 \cup S^1 \cup I \rightarrow T^2 \cup S^1$ so that it takes 1-handles to 1-handles, with an isotopy, eg,

$$\nu_t = \begin{matrix} \text{O} & & & \text{1} \\ & -t & 1-t & 0 \\ \text{B} & \text{1-t} & 1 & 0 \\ & 0 & 0 & -1 \\ & & & \text{A} \end{matrix}$$

Then attach an extra 1-handle and the 2-handles as indicated in second picture of Figure 10 (one of the attaching balls of the new 1-handle is not visible in the picture since it is placed at the point of infinity). The extra 2-handles are induced from the identification of the 1-handles of the two boundary components of $T^2 \cup S^1 \cup I$ via ν . So, the second picture of Figure 10 gives the handlebody of \hat{M} .

We want to emphasize that the new 1-handle identifies the 3-ball at the center of Figure 10 with the 3-ball at the infinity by the following diffeomorphism as indicated in Figure 11:

$$(x; y; z) \sim (x; -y; -z)$$

Figure 12 describes how part of this isotopy ν_t acts on T^2 (where T^2 is represented by a disk with opposite sides identified). This is exactly the reason why we started with $T^2 \cup S^1$ instead of $T_0^2 \cup S^1$ (this isotopy takes place in T^2 not in T_0^2 !).

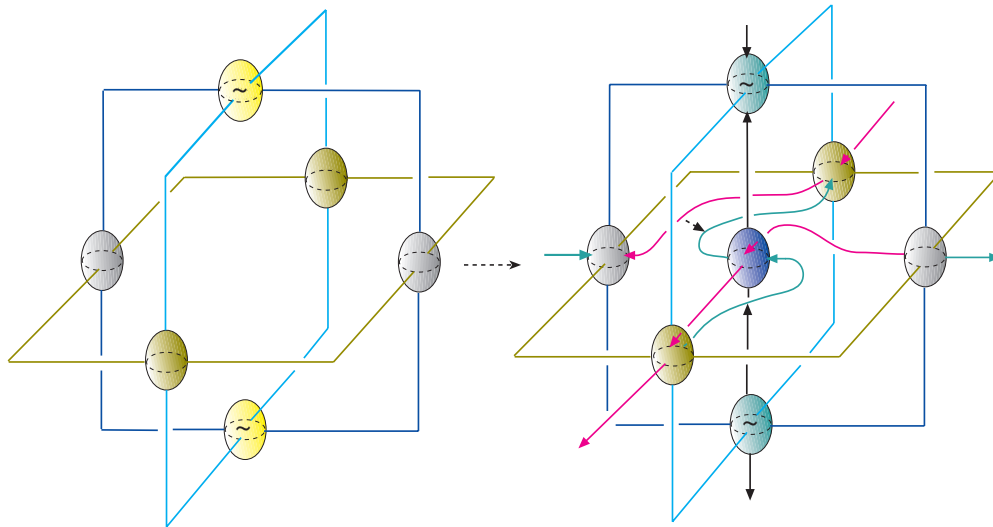

Figure 10

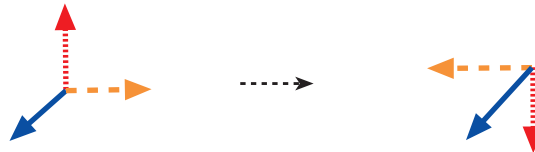

Figure 11

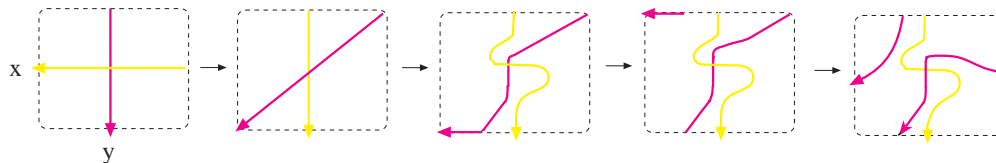

Figure 12

4 Simplifying the handlebody of $\hat{\mathcal{M}}$

We now want to simplify the handlebody of Figure 10 by cancelling some 1- and 2-handle pairs and by isotopies: We first perform the 2-handle slide as indicated (by the short arrow) in Figure 10 and obtain Figure 13. By doing the further 2-handle slides as indicated in Figures 13-15 we obtain Figure 16. Note that while going from Figure 15 to 16 we cancelled a 2-handle with a

3-handle (ie, we erased a zero framed unknotted circle from the picture).

Figure 17 is the same as Figure 16 except that the twisted 1-handle (two balls with 'tilde' on it) is drawn in the standard way. By an isotopy we go from Figure 17 to Figure 18. Figure 19 is the same as Figure 18 except that we drew one of the 1-handles in a different 1-handle notation (circle with a dot notation).

Note that in our figures, if the framing of a framed knot is the obvious 'black-board framing' we don't bother to indicate it, but if the framing deviates from the obvious black-board framing we indicate the deviation from to the black-board framing by putting a number in a circle on the knot (-1 's in the case of Figure 19).

Figure 20 is obtained from Figure 19 by simply leaving out one of the 2 handles. This is because the framed knot corresponding to this 2-handle is the unknot with 0-framing!, hence it is cancelled by a 3-handle (this knot is in fact the 'horizontal' framed knot of Figure 10).

Figure 21 is the desired handlebody of $\hat{\mathcal{M}}$, it is the same as the Figure 20, except that one of the attaching balls of a 1-handle which had been placed at the point of infinity is isotoped into \mathbf{R}^3 .

5 Checking that the boundary of $\hat{\mathcal{M}}$ is correct

Now we need to check that the boundary of the closed manifold $\hat{\mathcal{M}}$ (minus the three and four handles) is correct. That is, the boundary of Figure 21 is the connected sum of copies of $S^1 \times S^2$; so that after cancelling them with 3-handles we get S^3 , which is then capped by a 4-handle. This process is done by changing the interior of $\hat{\mathcal{M}}$ so that boundary becomes visible: By changing a 1-handle to a 2-handle in Figure 21 (ie, turning a 'dotted circle' to a zero framed circle) we obtain Figure 22. Then by doing the indicated handle slides and isotopies we arrive to Figures 23, 24 and 25. Then by operation of turning a 2-handle to a 1-handle by a surgery (ie, turning a zero framed circle to a 'dotted circle') and cancelling the resulting 1- and 2-handle pair we get Figure 26. By isotopies we obtain the Figure 28, which after surgering the obvious 2-handle becomes $S^1 \times B^3 \# S^1 \times B^3$ with the desired boundary.

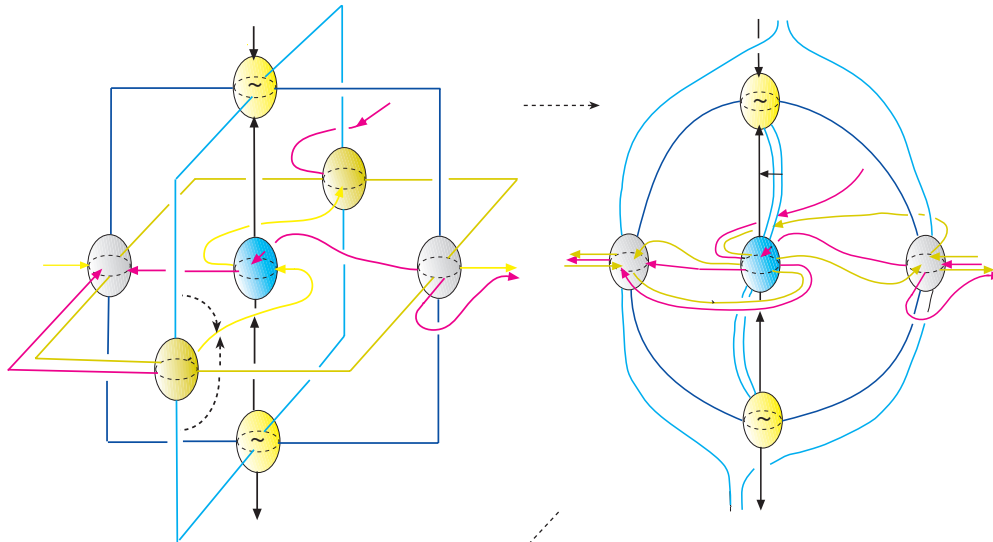

Figure 13

Figure 14

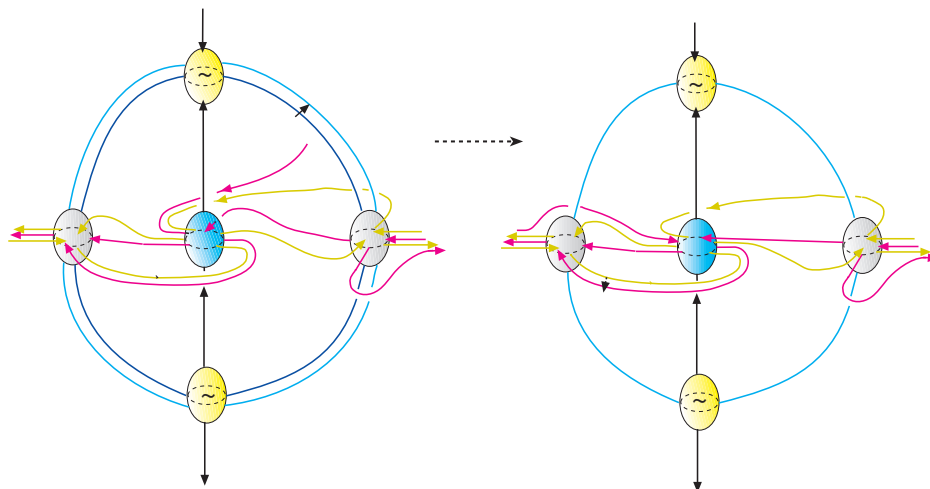

Figure 15

Figure 16

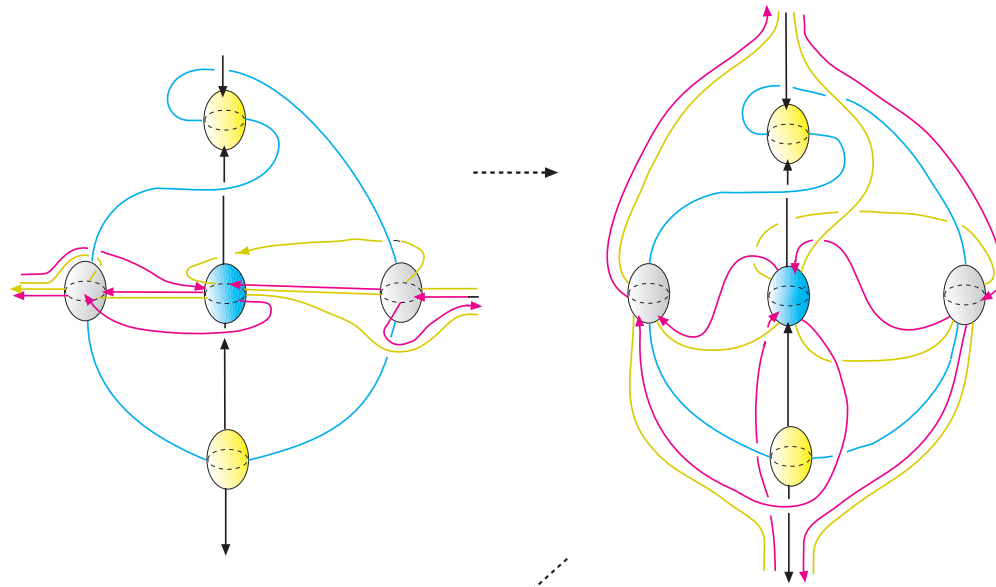

Figure 17

Figure 18

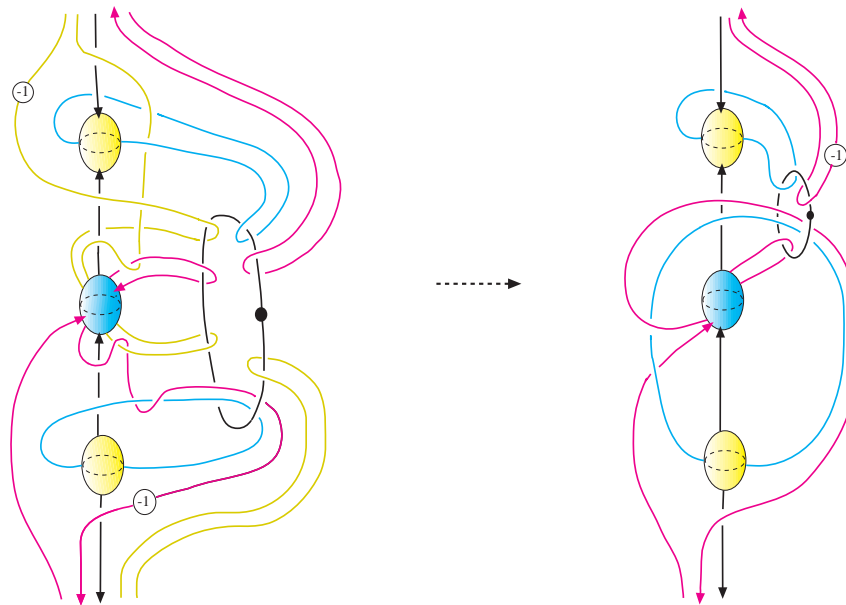

Figure 19

Figure 20

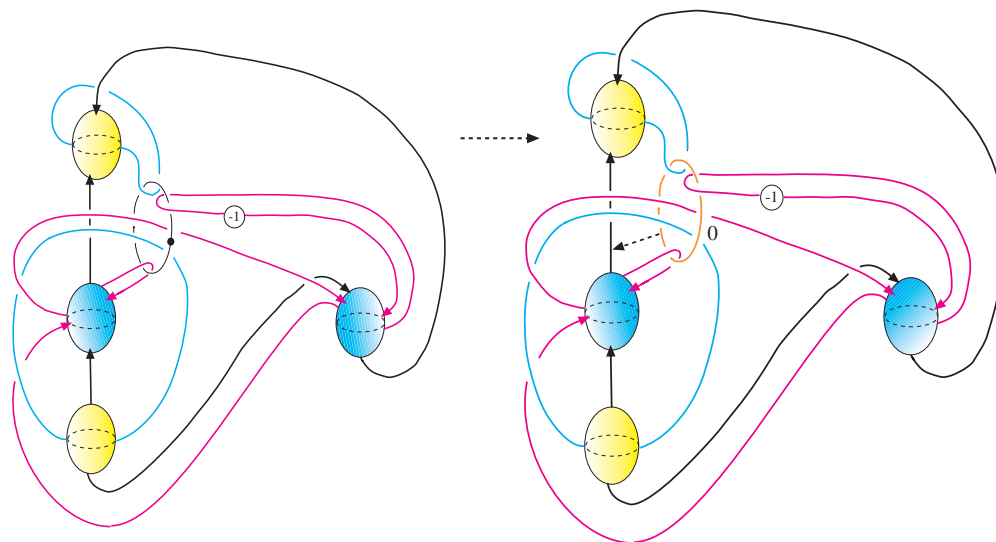

Figure 21

Figure 22

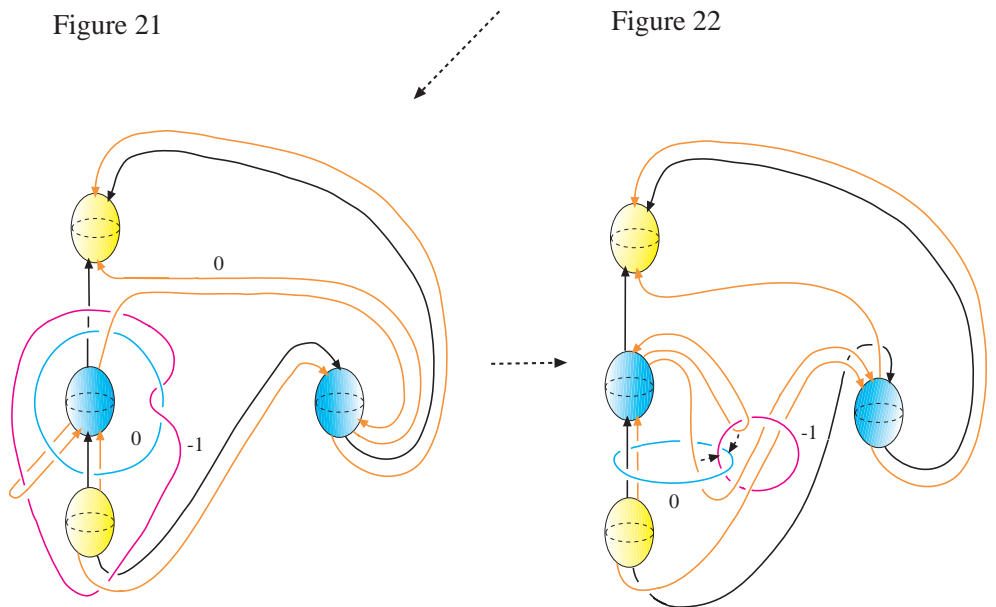

Figure 23

Figure 24

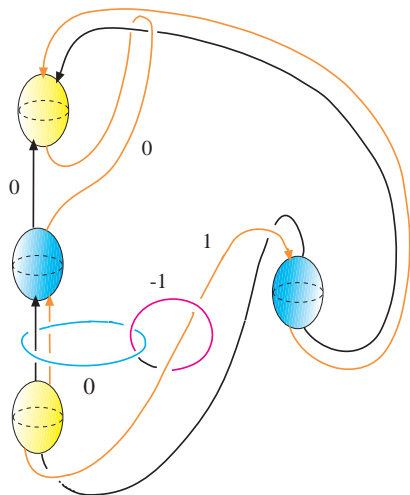

Figure 25

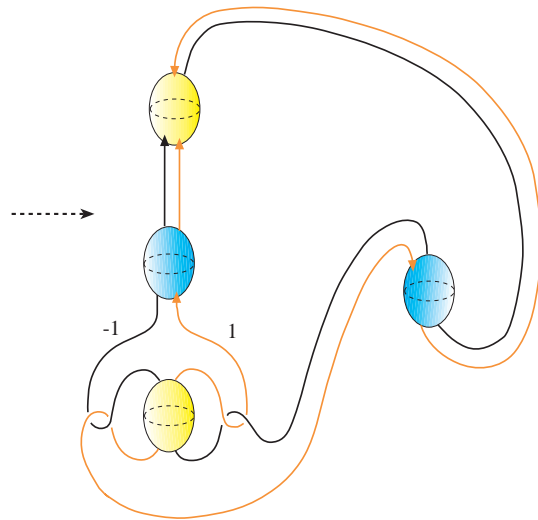

Figure 26

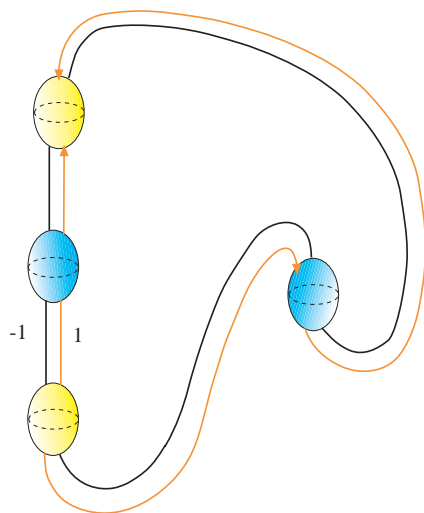

Figure 27

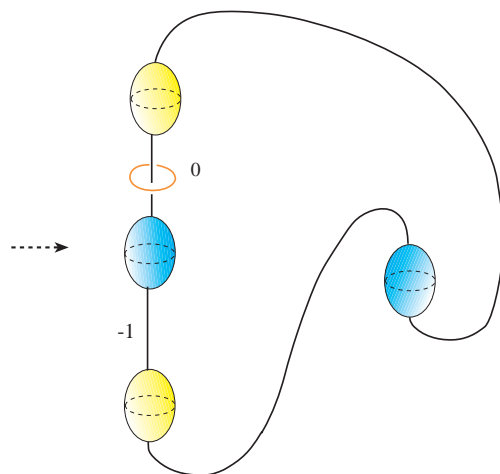

Figure 28

6 Turning \hat{M} upside down and constructing a handlebody of H

Evidently it is not so easy to obtain the handlebody of M from the closed manifold \hat{M} even though $M = \hat{M} - N$ and N is clearly visible as a subset in the handlebody of \hat{M} . For this, we will turn the handlebody of \hat{M} upside-down and take all the handles up to N (excluding N), and then attach a 2-handle h as indicated in Figures 30 and 31. Recall that this last 2-handle h is attached along the loop h of Figure 4, ie, h is the loop on $@N$ along which attaching a 2-handle to N gives $Q \cup [0;1]$ (here we are using the same notation h for the 2-handle and for its attaching circle).

To turn \hat{M} upside down we simply take the dual loops (attaching loops of the 2-handles of Figure 21, indicated by the small 0-framed circles in Figure 31) and the loop h , and then trace them via the diffeomorphism from the boundary of Figure 21 to the boundary of Figure 28, which is $(S^1 \times S^2) \# (S^1 \times S^2)$ (ie, the steps Figure 21 ; Figure 28); and then attach 2-handles to $(S^1 \times B^3) \# (S^1 \times B^3)$ along the image of these loops. Note that, during this process we are free to isotope these dual loops over the other handles. The reader unfamiliar with this process can consult [2].

Figure 31 ; Figure 38 is the same as the isotopy Figure 21 ; Figure 28, except that we carry the dual loops along and isotope them over the handles as indicated by the short arrows in these figures.

More explanation: By isotoping the dual loops as indicated in Figure 32 we arrive to Figure 33. The move Figure 33 ; Figure 34 is the same as Figure Figure 25 ; Figure 26. The move Figure 34 ; Figure 35 is just an isotopy (rotating the lower ball by 360° around the y -axis). By performing the handle slides as indicated by the arrows in the figures we obtain Figure 35 ; Figure 38. By changing the 1-handle notation we obtain Figure 39, by rotating the upper attaching ball of the 1-handle by 360° we obtain Figure 40. Then by a handle slide (indicated by the arrow) we obtain Figure 41. Changing the notation of the remaining 1-handles to 'circles-with-dots' we get Figure 42. Then by the indicated handle slide we get Figure 43, which is the same as Figure 44 (after an isotopy). The indicated handle slides gives the steps Figure 44 ; Figure 47. Figure 47 is our desired handlebody picture of H . The reader is suggested to compare this picture with the picture of $Q_0 \cup I$ in Figure 4. Here we also traced the position of the loop a lying on the boundary of $Q_0 \cup I$.

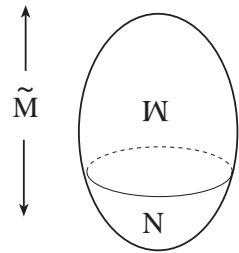

Figure 29

Turn upper part
upside down and
attach a 2-handle

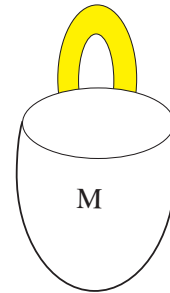
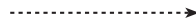

Figure 30

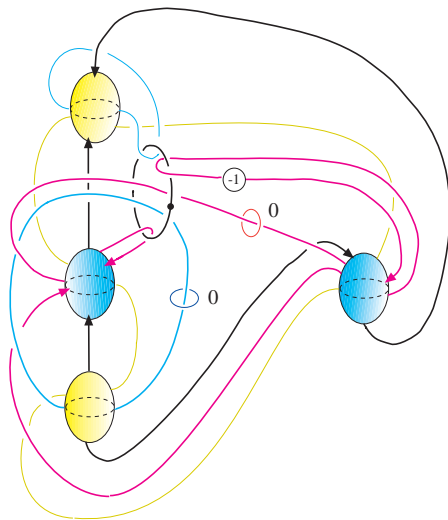
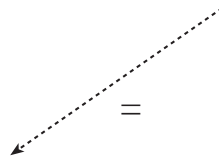

Figure 31

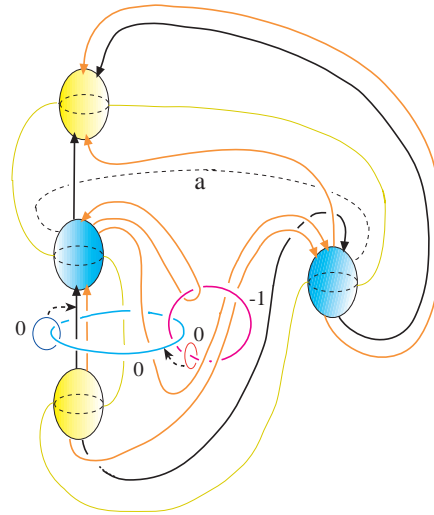

Figure 32

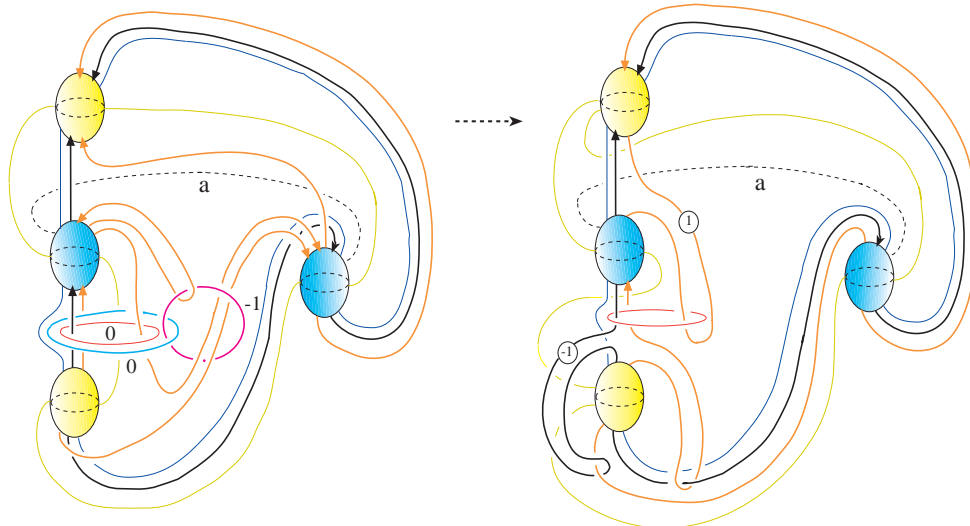

Figure 33

Figure 34

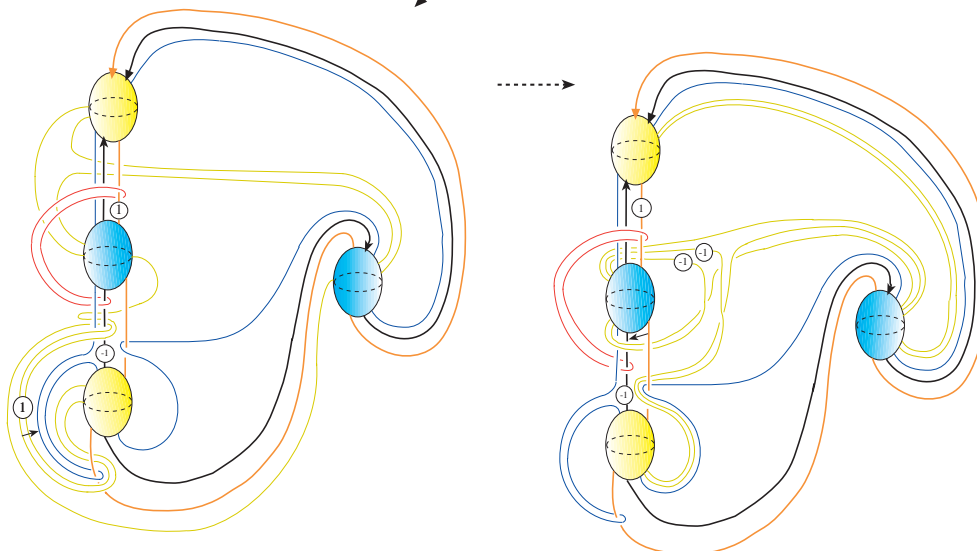

Figure 35

Figure 36

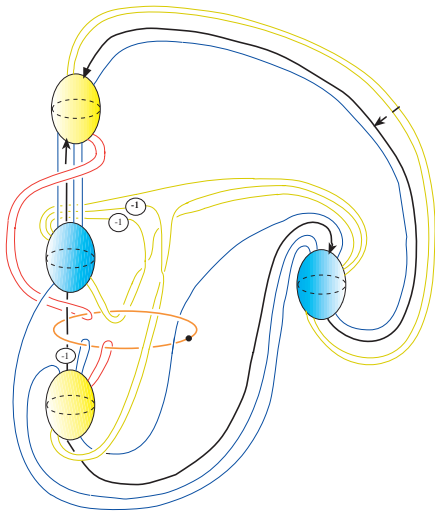

Figure 37

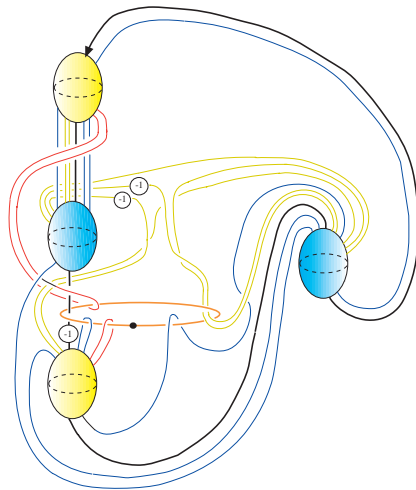

Figure 38

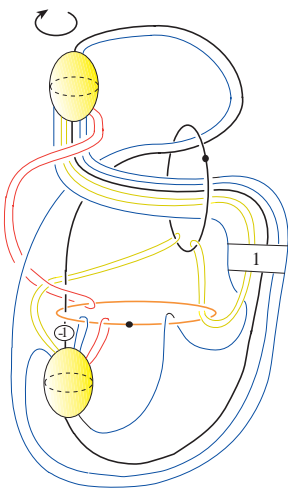
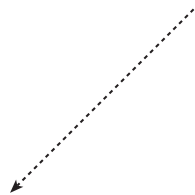

Figure 39

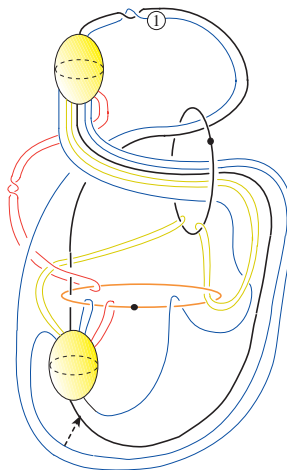

Figure 40

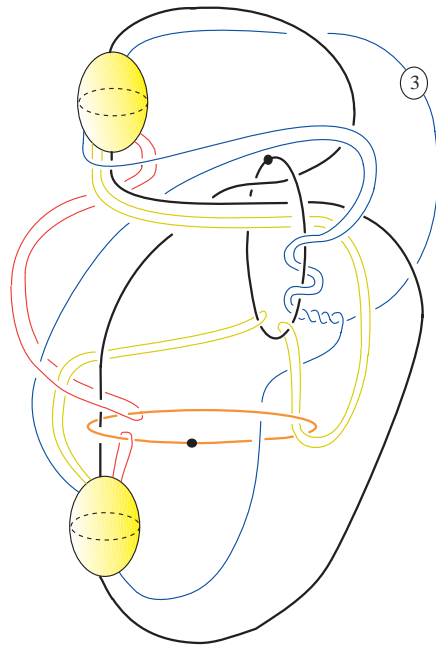

Figure 41

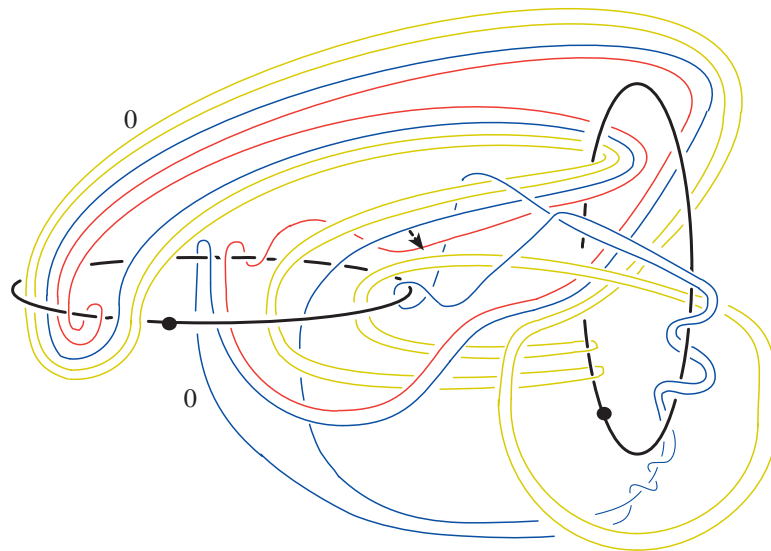

Figure 42

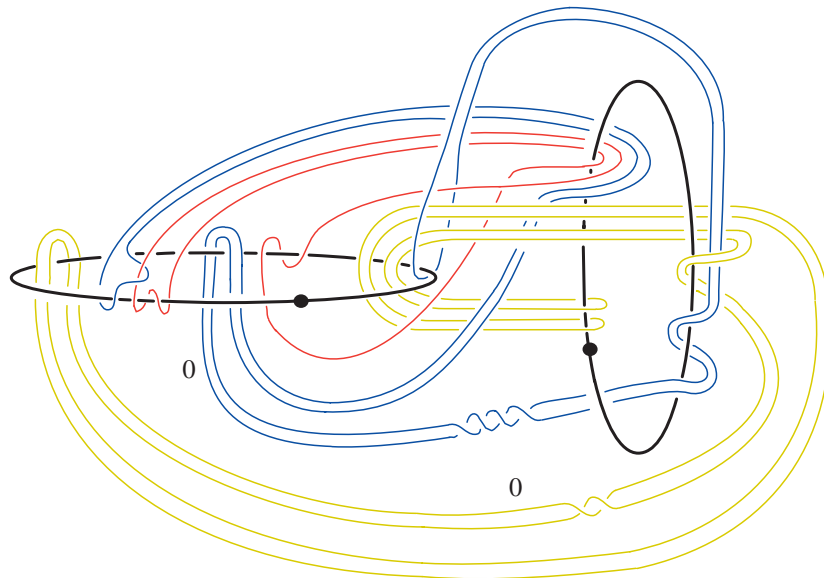

Figure 43

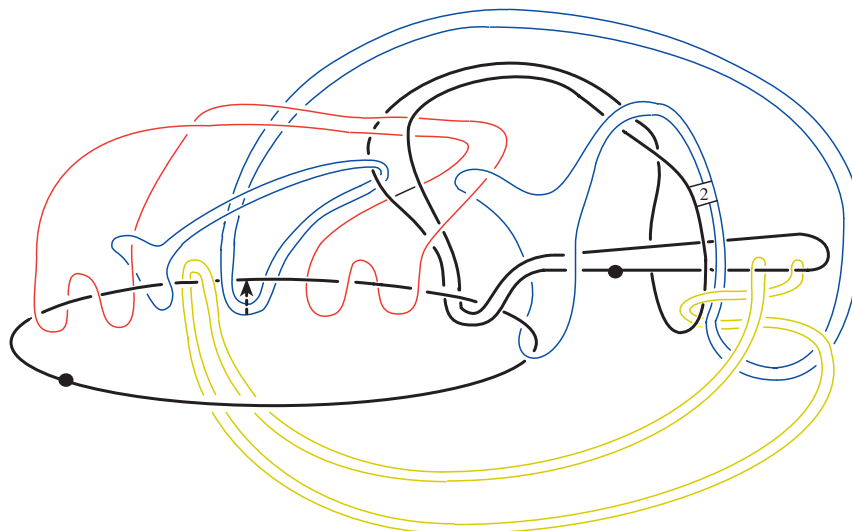
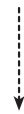

Figure 44

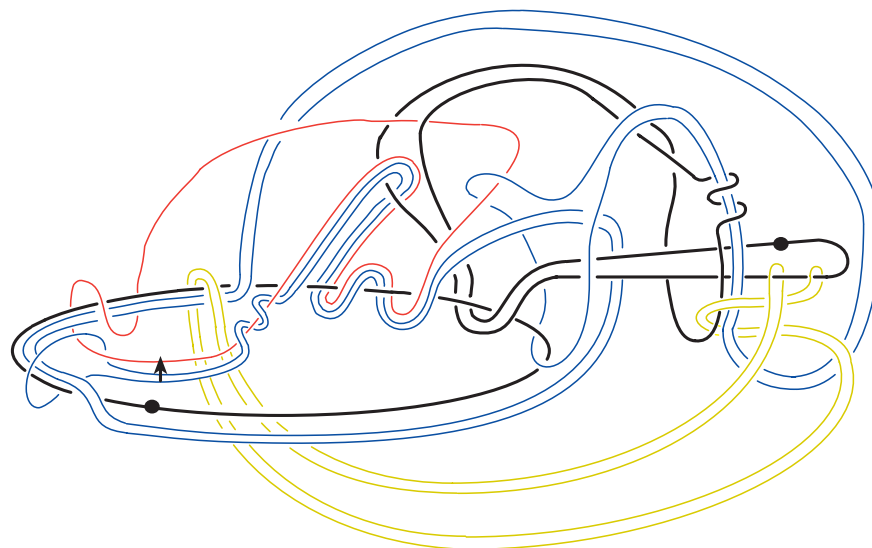

Figure 45

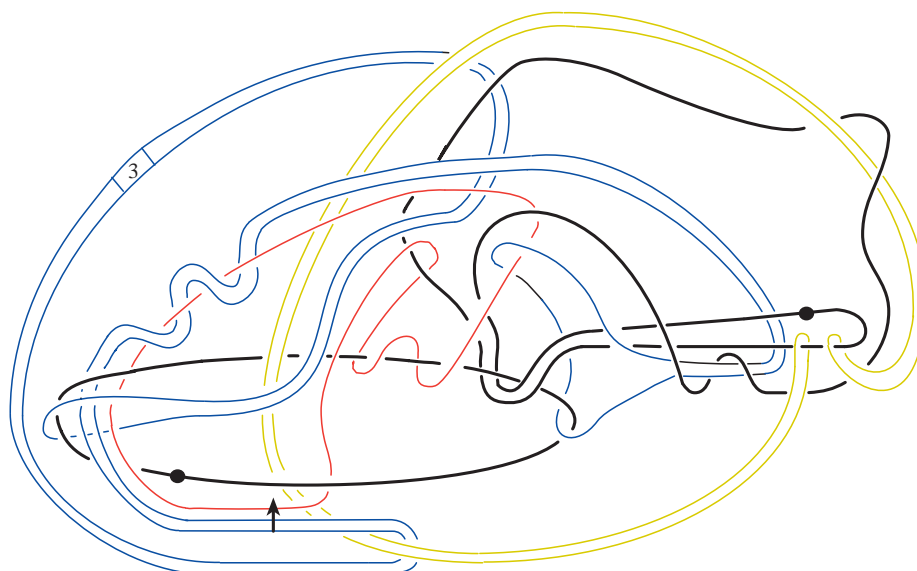

Figure 46

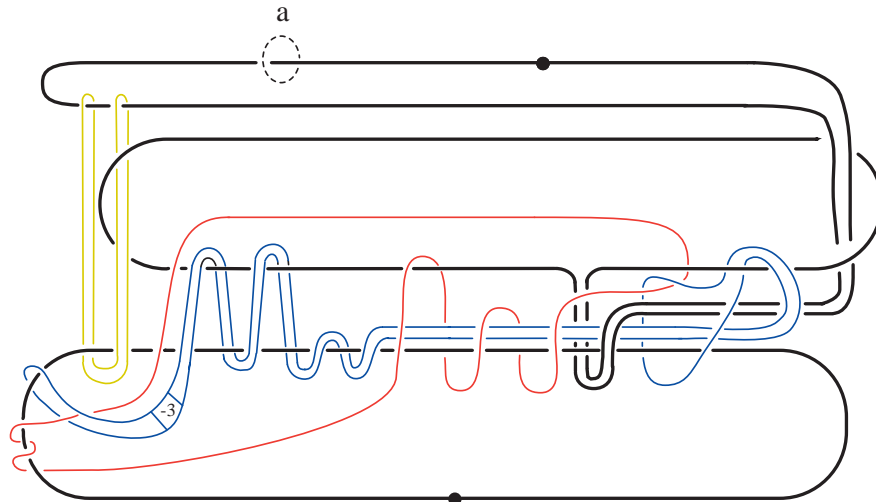

Figure 47

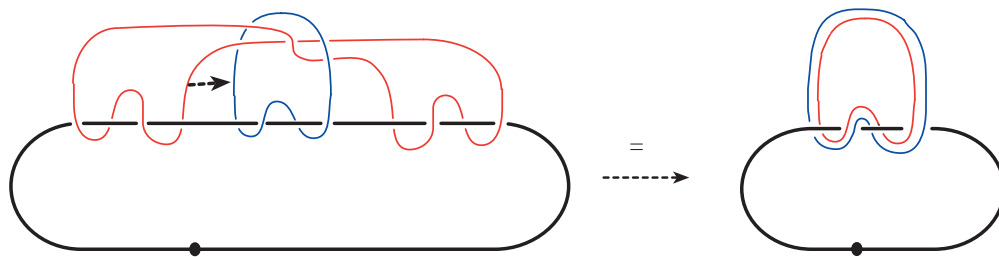

Figure 48

Figure 49

7 Capping the boundaries of H with W

H has two boundary components homeomorphic to Q , $\partial H = Q_- \sqcup Q_+$. Recall that by capping the either ends of H with W we obtained $W = H \hat{}_Q W$, and the handlebodies of W_- , W_+ are obtained by attaching 2-handles to H along the loops a , b in $\partial H = \partial(Q \cup I)$, respectively (Figure 4).

Proposition 4 $W_- = W$

Proof The diffeomorphism $\partial(Q \cup I) \cong \partial H$, takes the loop in a of Figure 4 to the loop a of Figure 47. By attaching a 2-handle to Figure 47, along the 0 framed loop a (and cancelling the resulting unknotted 0-framed circles by 3-handles) we get Figure 48. By the further indicated handle slide we obtain Figure 49. One of the 2-handles of Figure 49 slides over the other and becomes free, and hence gets cancelled by a 3-handle. So we end up with W . \square

The story with W_+ evolves differently, in coming sections we will see that W_+ has a more amusing nontrivial structure. In the next section we will use W_+ to examine H more closely.

8 Checking that the boundary of H is correct

A skeptical reader might wonder how she can verify that the boundary of Figure 47 is the same as the boundary of $Q \cup I$? We will check directly from Figure 47 that it has the same boundary as Figure 4. This will also be useful for locating the position of the loops a , b in Figure 47. By turning the 1-handles to 2-handles (ie, by replacing dotted-circles by 0-framed circles), and by blowing up $\{$ then handle sliding $\}$ then a blowing down operation (done twice) we obtain Figure 47 ; Figure 50. By isotopies and the indicated handle sliding operations we obtain Figure 50 ; Figure 58. By the indicated handle sliding operation, and by surgering the 2-handles of Figure 58 we obtain Figure 59 which is $Q \cup I$.

By tracing back the boundary diffeomorphism Figure 59 ; Figure 47 gives the positions of the curves a and b on the boundary of Figure 47, which is indicated in Figure 60. Recall that attaching a 2-handle to Figure 60 along b (with 0-framing) gives W_+ . Attaching a 2-handle to b and handle slidings and cancelling a 1- and 2-handle pair gives Figure 61, a picture of W_+ which is

seemingly different than W . Figure 61 should be considered a "vertical picture" of H built over the handlebody of W (notice W is visible in this picture). In the next section we will construct a surprisingly simpler "vertical" handlebody picture of H .

9 Vertical handlebody of H

Here we will construct a simpler handlebody picture of H as a vertical cobordism starting from the boundary of W to Q . This is done by starting with Figure 6, which is $W = W \cup_{\partial} (Q \cup I)$, and then by replacing in the interior an imbedded copy of $N \cup (Q \cup I)$ by M . This process gives us W_+ , with an imbedding $W \subset W_+$, such that $H = W_+ - W$. This way we will not only simplify the handlebody of H but also demonstrate the crucial difference between W_+ and W_- .

We proceed as in Figure 31, except that when we turn M upside down we add pair of 2-handles to the boundary along the loops H_1 and H_2 of Figure 6 (instead of the loop h of Figure 4). This gives Figure 62. We then apply the boundary diffeomorphism Figure 21 ; Figure 28, by carrying the 2-handles H_1 and H_2 along the way (we are free to slide H_1 and H_2 over the other handles). For example, Figure 68 corresponds to Figure 36.

By performing the indicated handle slides (indicated by the short arrows) we obtain Figure 68 ; Figure 69, which corresponds to Figure 37. Then by performing the indicated handle slides we obtain Figure 69 ; Figure 71. We then change the 1-handle notation from pair of balls to the dotted-circles to obtain Figure 72; and by the indicated handle slides Figure 72 ; Figure 77 we arrive to Figure 77. Figure 77 is the desired picture of W_+ .

Next we check that the boundary of the manifold of Figure 77 is correct. This can easily be done by turning one of the dotted circles to a 0-framed circle, and turning a 0-framed circle to a dotted circle as in Figure 78 and then by cancelling the dotted circle with the -1 framed circle which links it geometrically once (ie, we cancel a 1- and 2-handle pair). It easily checked that this operation results W and a disjoint 0-framed unknotted circle, which is then cancelled by a 3-handle. So we end up with W , hence W_+ has the correct boundary.

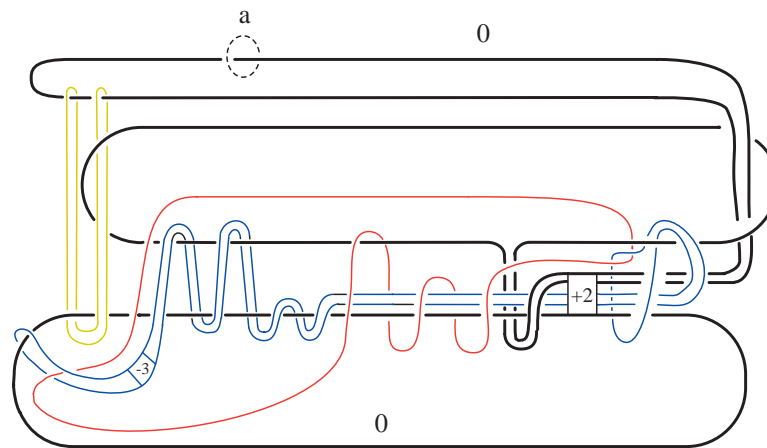

Figure 50

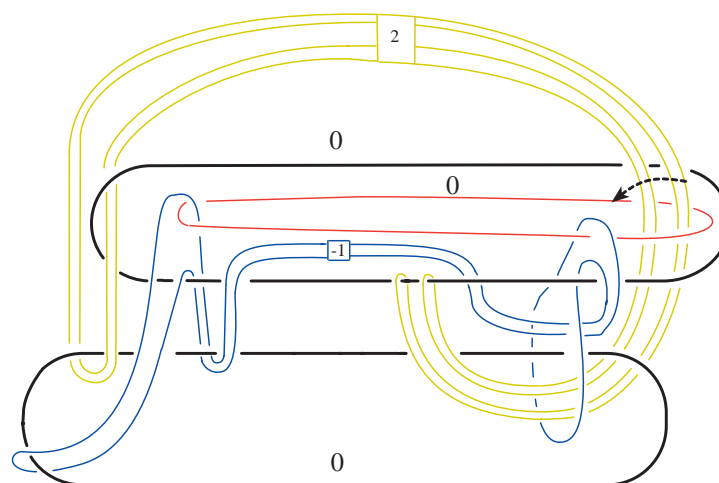

Figure 51

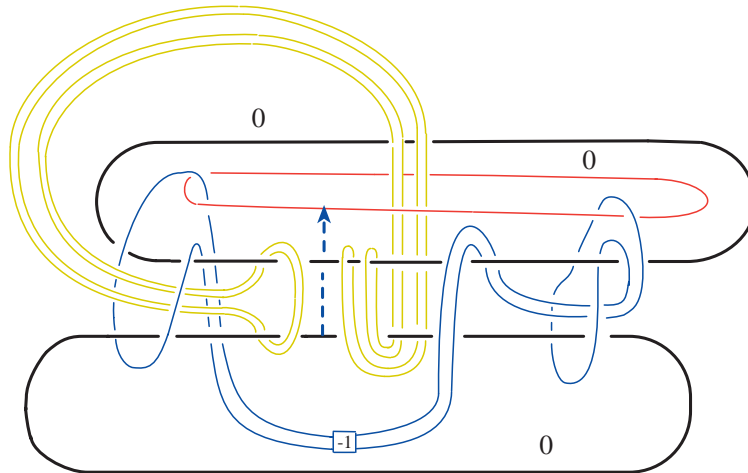

Figure 52

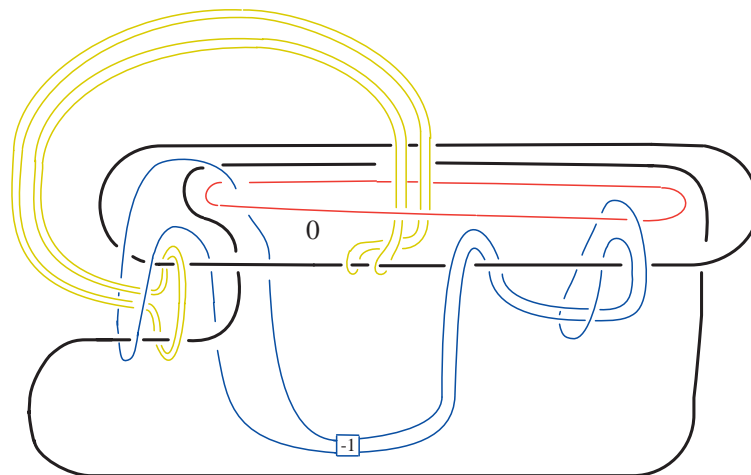

Figure 53

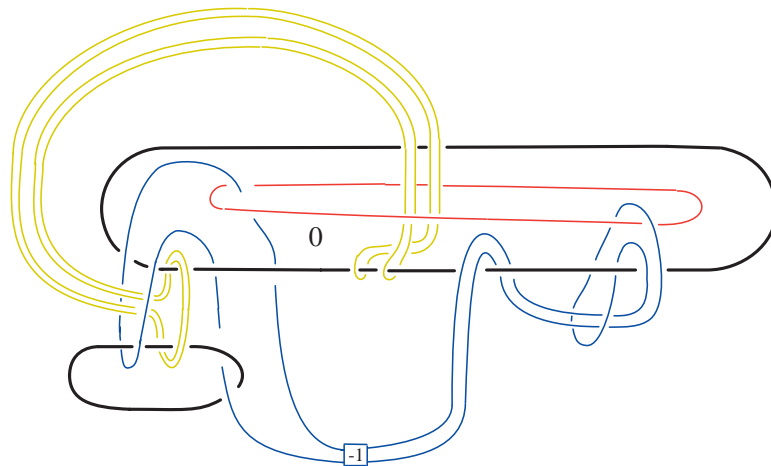

Figure 54

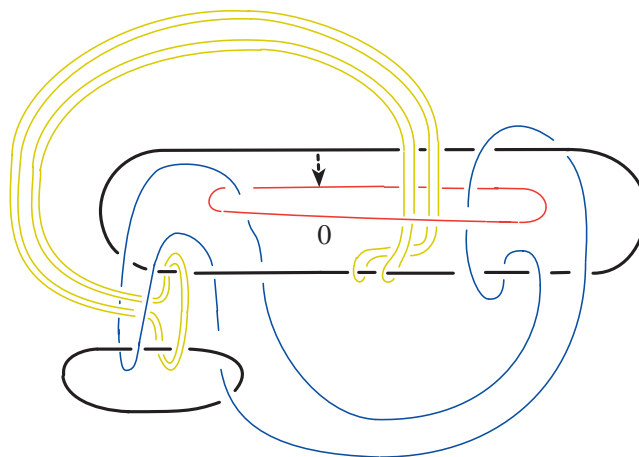

Figure 55

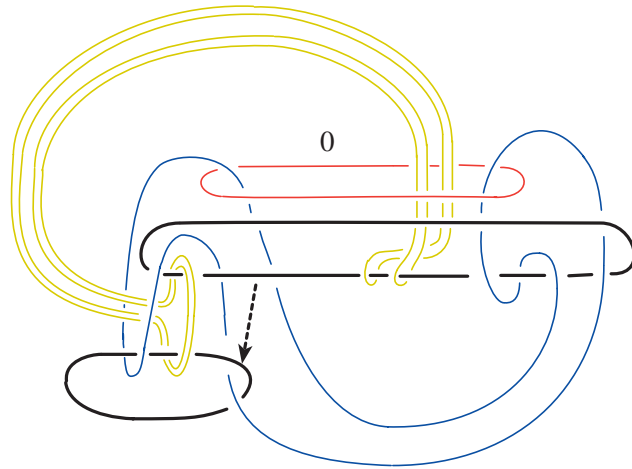

Figure 56

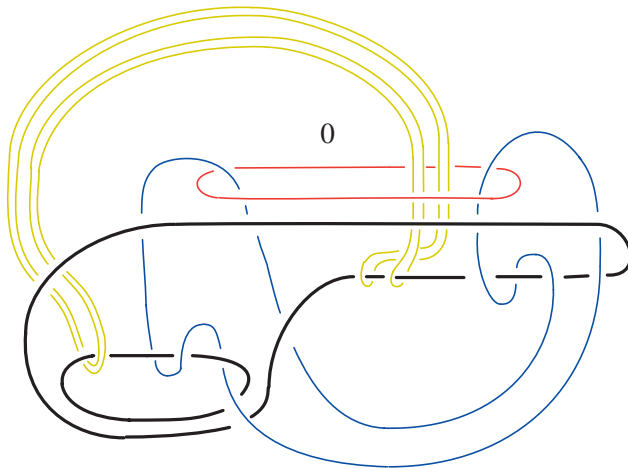

Figure 57

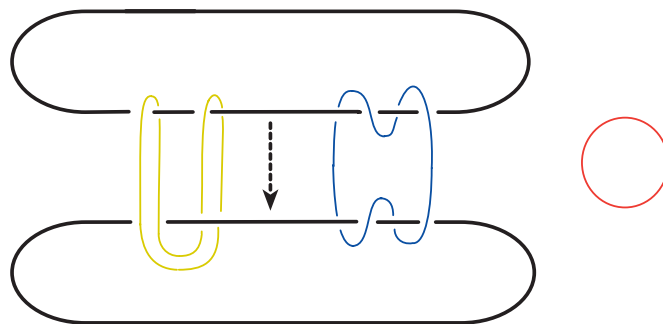

Figure 58

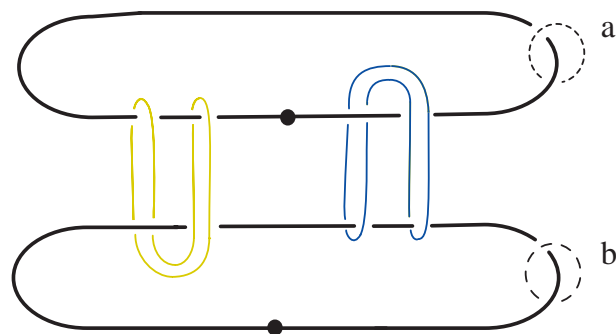

Figure 59

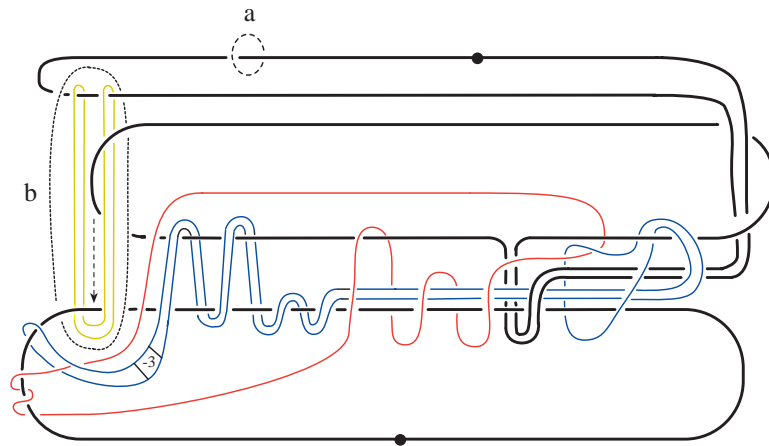

Figure 60

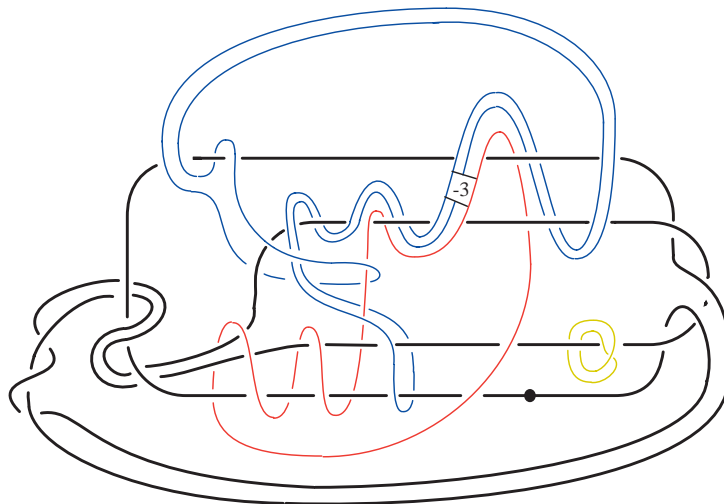

Figure 61

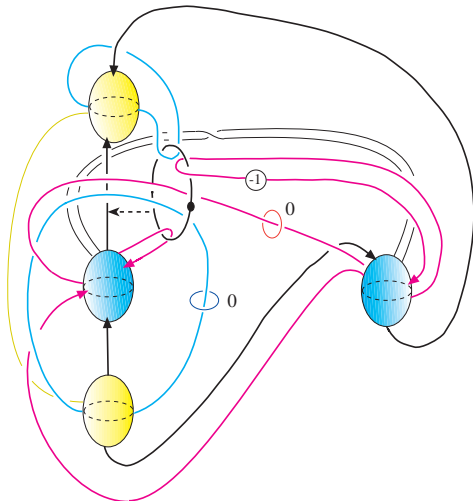

Figure 62

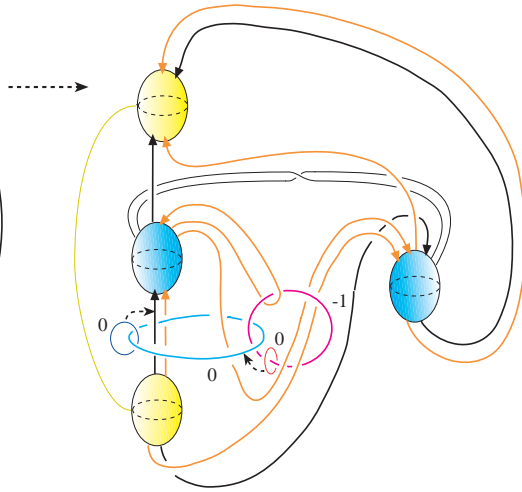

Figure 63

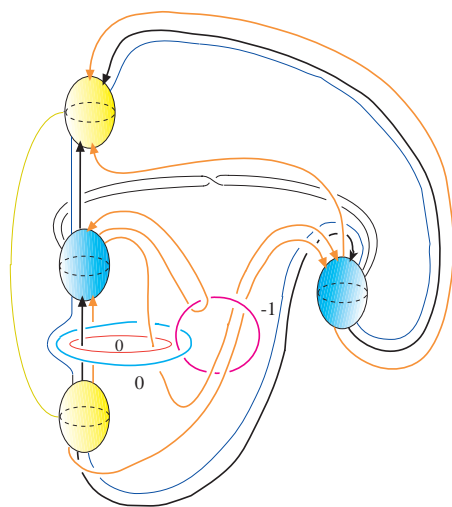

Figure 64

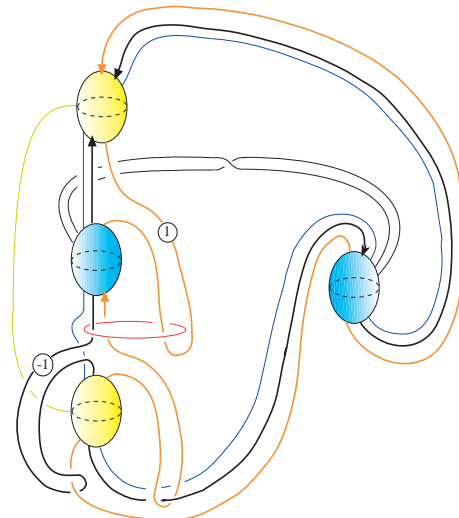

Figure 65

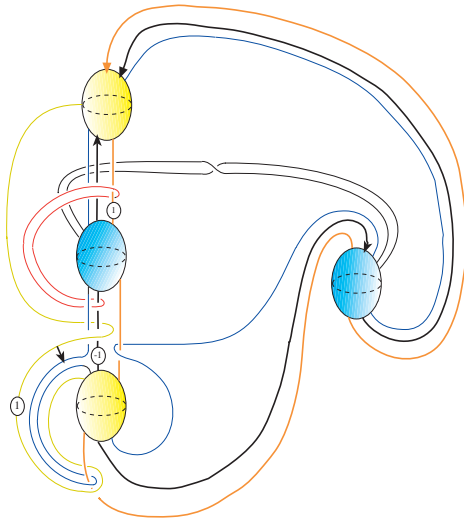

Figure 66

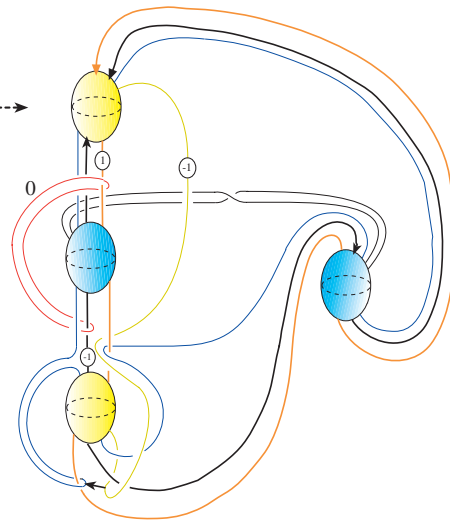
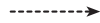

Figure 67

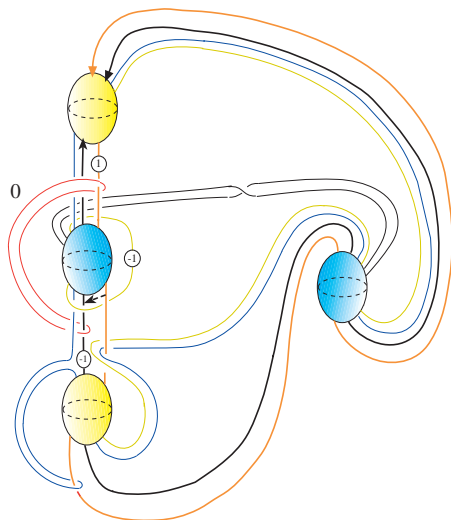
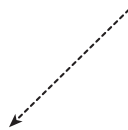

Figure 68

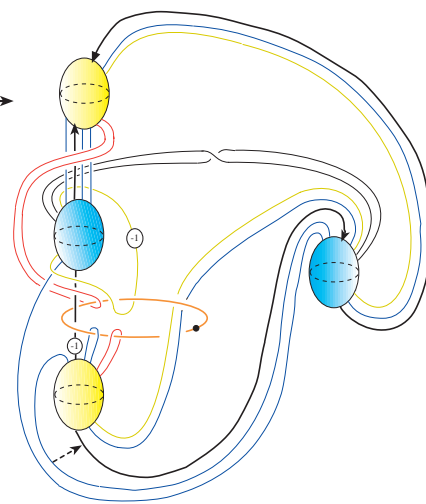
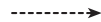

Figure 69

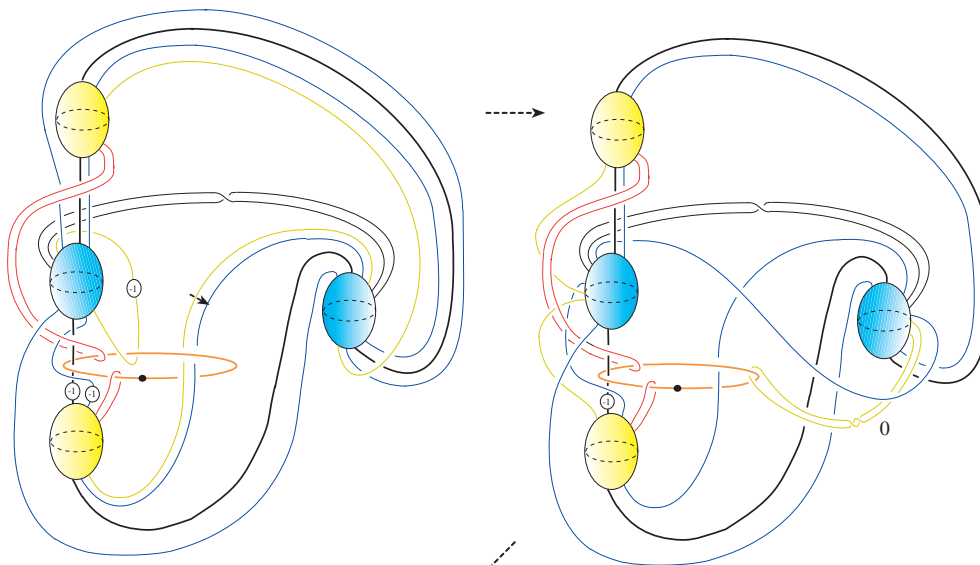

Figure 70

Figure 71

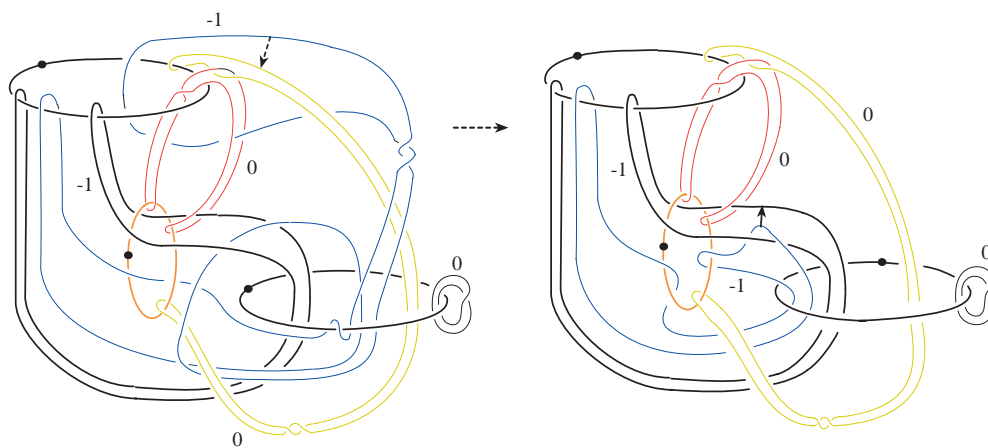

Figure 72

Figure 73

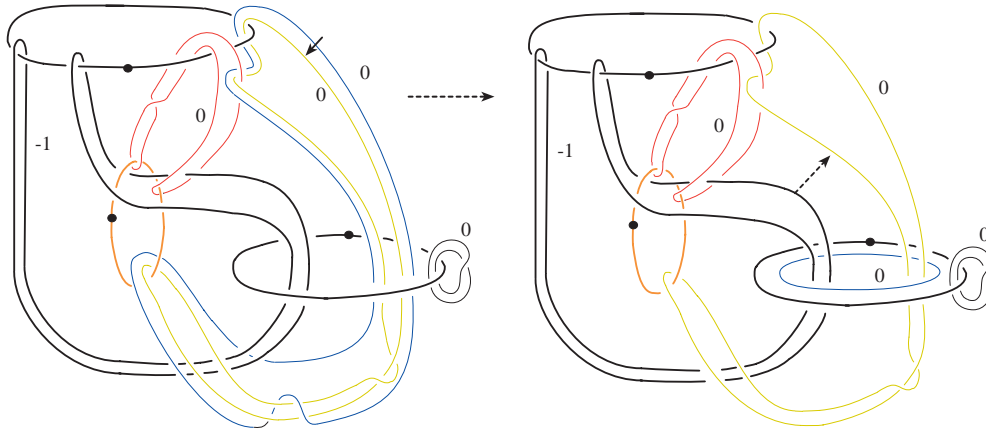

Figure 74

Figure 75

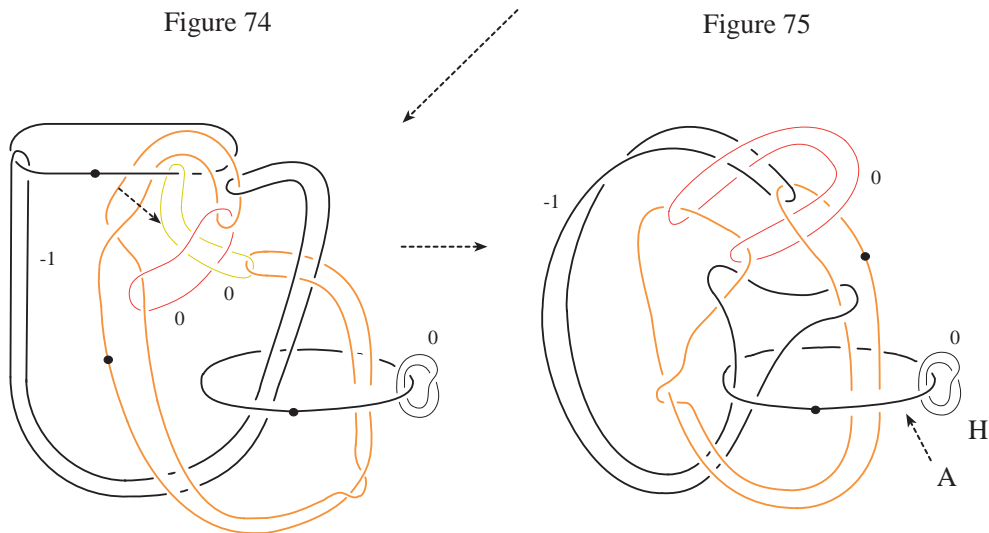

Figure 76

Figure 77

10 A knot is born

By twisting the strands going through the middle 1-handle, and then by sliding H_1 over this 1-handle we see that Figure 77 is diffeomorphic to the Figure 79 (similar to the move at the bottom of the page 504 of [2]). Figure 79 demonstrates the complement of the imbedding $f: B^2 \hookrightarrow B^4$ with the standard boundary, given by the "dotted circle" A (the 1-handle). This follows from the discussion on the last paragraph of the last section. Because there by changing the interior of Figure 77 we checked that as a loop A is the unknot on the boundary of the handlebody X consisting of all the handles of Figure 77 except the 1-handle corresponding to A and the last 2-handle H_1 . The same argument works for Figure 79. In addition in this case, the handlebody consisting of all the handles of the Figure 79 except the 1-handle corresponding to A and the the 2-handle H_1 , is B^4 . So W_+ is obtained from B^4 by carving out of the imbedded disk bounded by the unknot A (i.e creating a 1-handle A) and then by attaching the 2-handle H_1 . Hence by capping with a standard pair $(B^4; B^2)$ we can think of f as a part of an imbedding $F: S^2 \hookrightarrow S^4$. Let us call $A = F(S^2)$.

We can draw a more concrete picture of the knot A as follows: During the next few steps, in order not to clog up the picture, we won't draw the last 2-handle H_1 . By an isotopy and cancelling 1- and 2-handle pair we get a diffeomorphism from Figure 79, to Figures 80, 81 and finally to Figure 82. In Figure 82 the 'dotted' ribbon knot is really the unknot in the presence of a cancelling 2 and 3-handle pair (ie, the unknotted circle with 0-framing plus the 3-handle which is not seen in the figure). So this ribbon disk with the boundary the unknot in S^3 , demonstrates a good visual picture of the imbedding $f: B^2 \hookrightarrow B^4$.

10.1 A useful fundamental group calculation

We will compute the fundamental group of the 2-knot complement $S^4 - A$, ie, we will compute the group $G := \pi_1(Y)$, where Y is the handlebody consisting of all the handles of Figure 79 except the 2-handle H_1 . Though this calculation is not necessary for the rest of the paper, it is useful to demonstrate why $W_+ - W$ gives an 5-cobordism. By using the generators drawn in Figure 83 we get the following relations for G :

$$\begin{aligned} (1) \quad x^{-1}yt^{-1}x^{-1}t &= 1 \\ (2) \quad x^{-1}yxy &= 1 \\ (3) \quad txt^{-1}y^{-1} &= 1 \end{aligned}$$

From (1) and (2) we get $t^{-1}x^{-1}t = xy$, then by using (3) $\Rightarrow t^3 = (tx)^3$. Call $a = tx$ so $t^3 = a^3$. By solving y in (3) and plugging into (2) and substituting $x = t^{-1}a$ we get $ata = tat^{-2}a^3 = tat^{-2}t^3 = tat$. Hence we get the presentation:

$$G = \langle ht; ajt^3 = a^3; ata = tati \rangle$$

Notice that attaching the 2-handle H_1 to Y (ie, forming W_+) introduces the extra relation $t^4 = 1$ to G , which then implies $t = x$, demonstrating an s-cobordism from the boundary of W to the boundary to W_+ . The following important observation of Meierfrankenfeld has motivated us to prove the crucial

Lemma 5 [14] *G contains normal subgroups \mathbf{Q}_8 and \mathbf{Z} giving the exact sequences:*

$$\begin{aligned} 1 & \rightarrow \mathbf{Q}_8 \rightarrow G \rightarrow \mathbf{Z} \rightarrow 1 \\ 1 & \rightarrow \mathbf{Z} \rightarrow G \rightarrow SL(2; \mathbf{Z}_3) \rightarrow 1 \end{aligned}$$

Proof Call $u := ta^{-1} = y^{-1}$ and $v := a^{-1}t = x^{-1}$. First notice that the group $\langle hu; vi \rangle$ generated by u and v is a normal subgroup. For example, since $u = ta^{-1} = a^{-1}t^{-1}at = a^{-1}v^{-1}t = a^{-1}v^{-1}av \Rightarrow a^{-1}va = uv^{-1} \in \langle hu; vi \rangle$. Also since $v = a^{-1}t = a^{-1}ua \Rightarrow a^{-1}ua = v \in \langle hu; vi \rangle$. Now we claim that $\langle hu; vi \rangle = \mathbf{Q}_8$. This follows from $a^3 = t^3 \in \text{Center}(G) \Rightarrow u = a^{-3}ua^3 = a^{-1}(vu^{-1})a = vu^{-1}v^{-1} \Rightarrow uvu = v$. So $vu^{-1} = a^{-1}va = a^{-1}(uvu)a = (a^{-1}ua)(a^{-1}va)(a^{-1}ua) = v(vu^{-1})v$, implying $vuv = u$. So $\langle hu; vi \rangle = \langle hu; v; uvu = v; vuv = u \rangle$, which is a presentation of \mathbf{Q}_8 .

For the second exact sequence take $\mathbf{Z} = \langle ht^3 \rangle$ and then observe that $G/\langle ht^3 \rangle = SL(2; \mathbf{Z}_3)$ (for example, by using the symbolic manipulation program GAP one can check that $G/\langle ht^3 \rangle$ has order 24, then use the group theory fact that $SL(2; \mathbf{Z}_3)$ is the only group of order 24 generated by two elements of order 3) □

10.2 Fiber structure of the knot A

Consider the order three self diffeomorphism $\tau : Q \rightarrow Q$ of Figure 84. As described by the the pictures of Figure 85, this diffeomorphism is obtained by the compositions of blowing up, a handle slide, blowing down, and another handle slide operations. τ permutes the circles $P; Q; R$ as indicated in Figure 84, while twisting the tubular neighborhood of R by -1 times. Note that Q can be obtained by doing -1 surgeries to three right-handed Hopf circles, then τ is the map induced from the map $S^3 \rightarrow S^3$ which permutes the three Hopf circles. Let Q_0 denote the punctured Q , then:

Proposition 6 *The knot $A \subset S^4$ is a fibered knot with fiber Q_0 and monodromy τ .*

Proof We start with Figure 86 which is the knot complement Y . By introducing a zero framed unknotted circle (ie, by introducing a cancelling pair of 2- and 3-handles) we arrive to the Figure 87. Now something amazing happens!: This new zero framed unknotted circle isotopes to the complicated looking circle of Figure 88, as indicated in the figure. The curious reader can check this by applying the boundary diffeomorphism (Figure 77) τ Figure 78 to Figure 88 (replacing dotted circle with a zero framed circle) and tracing this new loop along the way back to the trivial loop!. By isotopies and the indicated handle slides, from Figure 88 we arrive to Figure 92.

Now in Figure 92 we can clearly see an imbedded copy of $Q \subset [0;1]$ (recall Figures 3 and 4). We claim that, in fact the other handles of this figure has the role of identifying the two ends of $Q \subset [0;1]$ by the monodromy τ . To see this, recall from [4] how to draw the handlebody of picture of :

$$Q_0 \subset [0;1] = (x;0) \cup (\tau(x);1)$$

For this, we attach a 1-handle to $Q_0 \subset [0;1]$ connecting the top to the bottom, and attach 2-handles along the loops $\# \langle \gamma_i \rangle$ where γ_i are the core circles of the 1-handles of $Q \subset 0$ and $\langle \gamma_i \rangle$ are their images in $Q \subset 1$ under the map τ (the connected sum is taken along the 1-handle). By inspecting where the 2-handles are attached on the boundary of $Q_0 \subset [0;1]$ (Figure 93), we see that in fact the two ends are identified exactly by the diffeomorphism τ . Note that, by changing the monodromy of Figure 94 by τ^{-1} we obtain Figure 95, which is the identity monodromy identification $Q \subset S^1$. \square

11 The Gluck Construction

Recall that performing the Gluck construction to S^4 along an imbedded 2-sphere $S^2 \hookrightarrow S^4$ means that we first thicken the imbedding $S^2 \hookrightarrow B^2 \hookrightarrow S^4$ and then form:

$$= (S^4 - S^2 \times B^2) \cup S^2 \times B^2$$

where $\tau : S^2 \times S^1 \rightarrow S^2 \times S^1$ is the diffeomorphism given by $(x; y) = (\tau(y)x; y)$, and $\tau : S^1 \rightarrow SO(3)$ is the generator of $\pi_1(SO(3)) = \mathbf{Z}_2$.

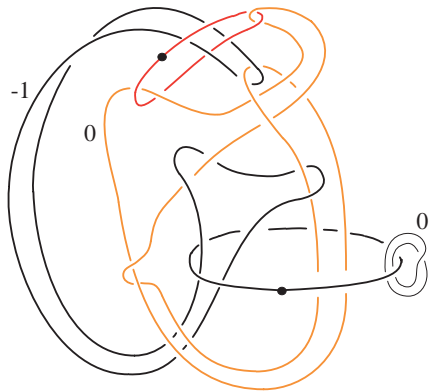

Figure 78

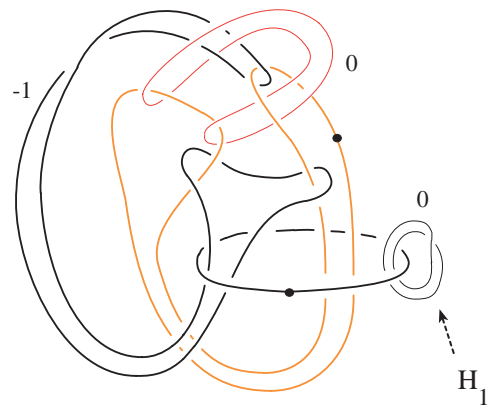

Figure 79

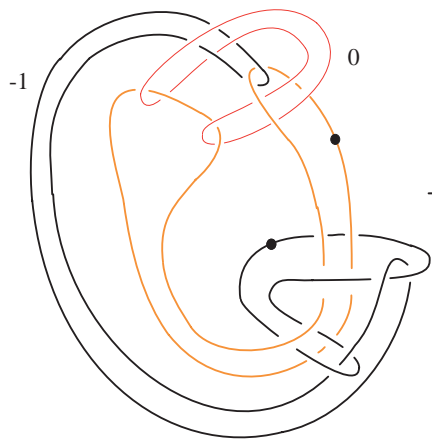
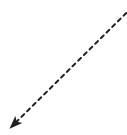

Figure 80

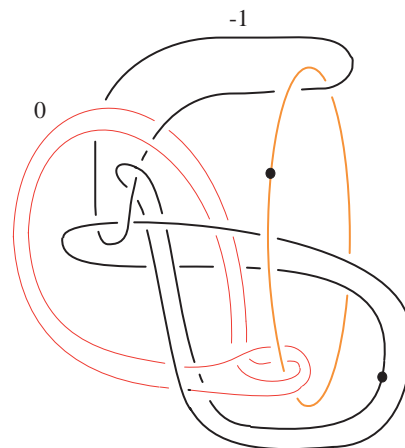
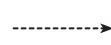

Figure 81

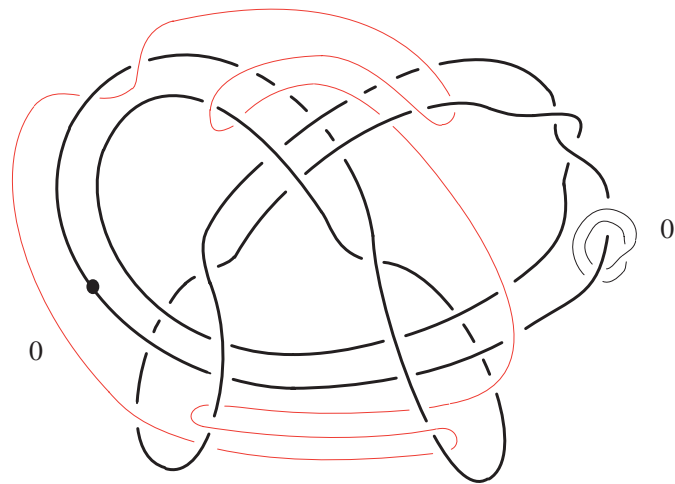

Figure 82

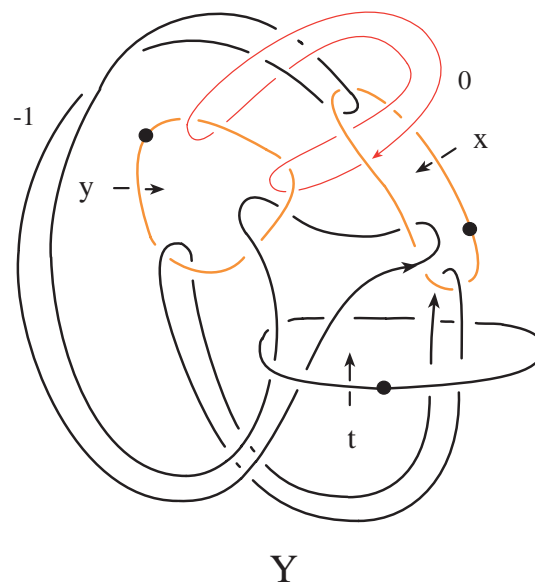

Figure 83

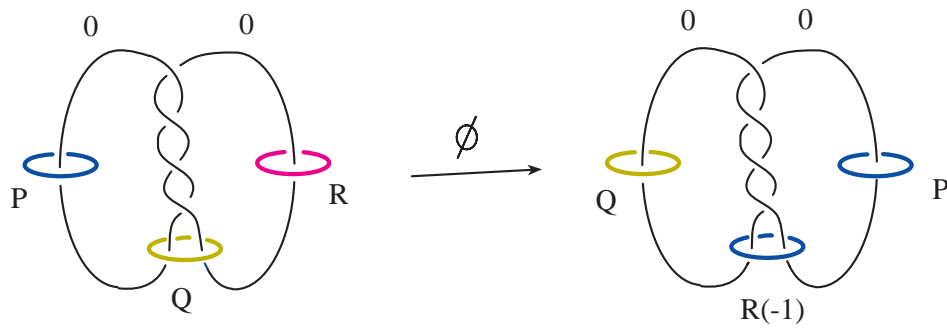

Figure 84

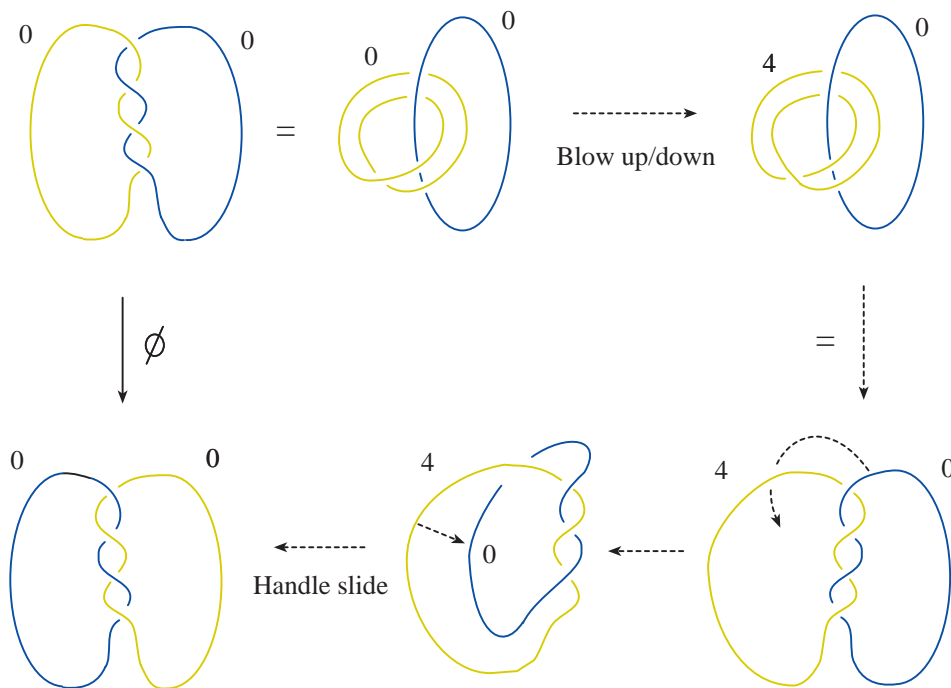

Figure 85

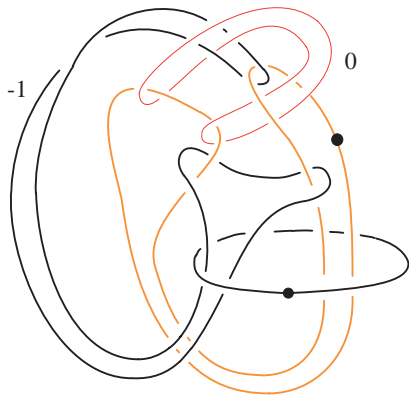

Figure 86

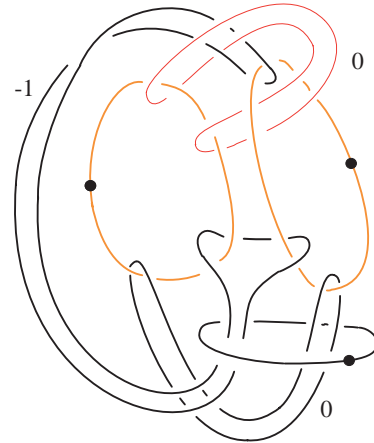
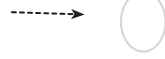

Figure 87

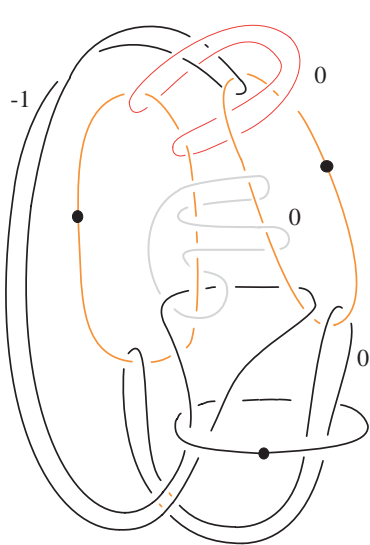
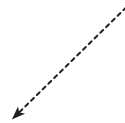

Figure 88

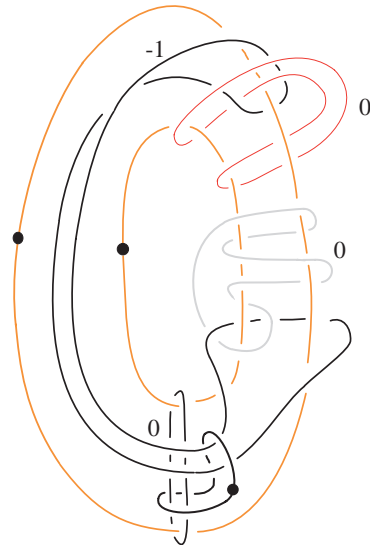

Figure 89

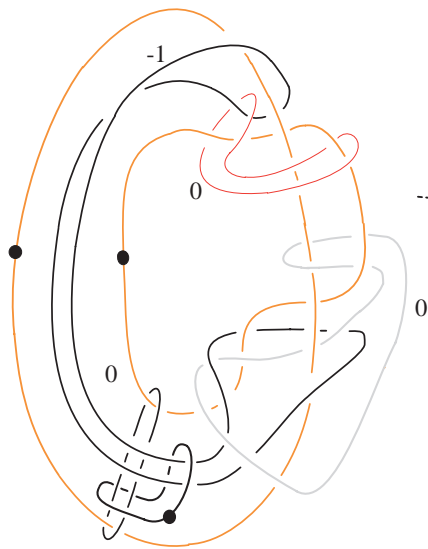

Figure 90

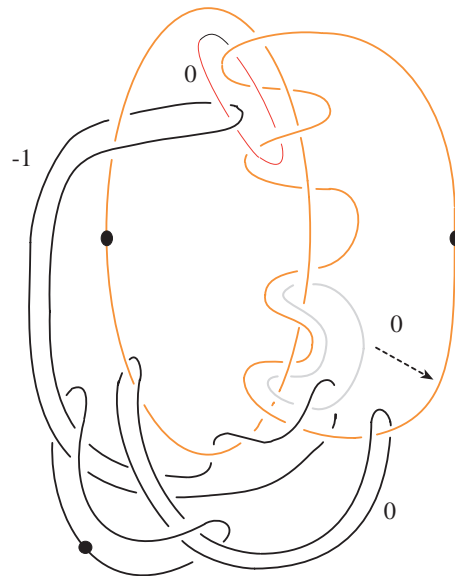

Figure 91

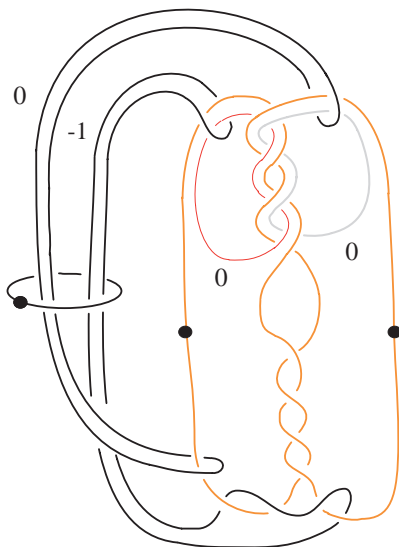

Figure 92

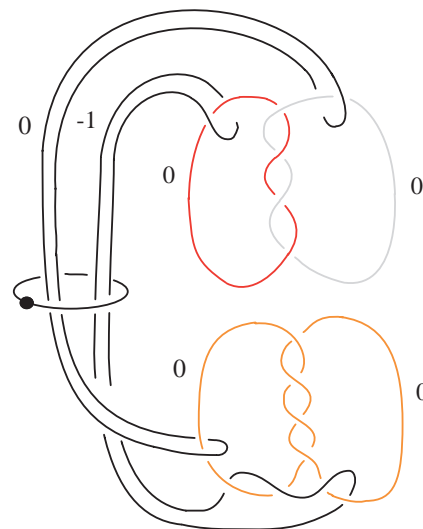

Figure 93

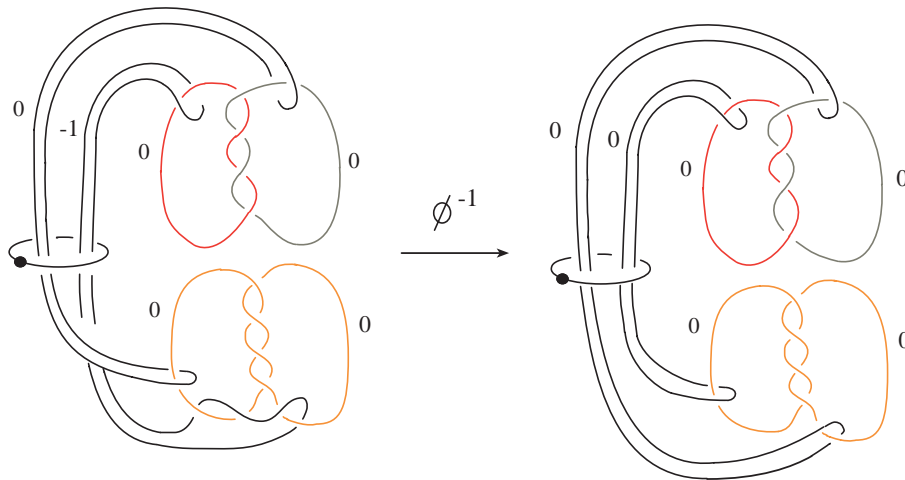

Figure 94

Figure 95

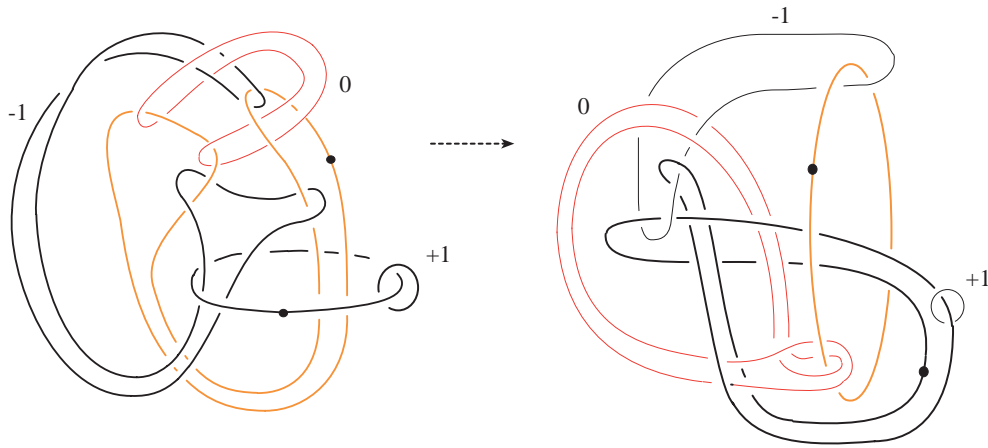

Figure 96

Figure 97

Proposition 7 *The Gluck construction to S^4 along the 2{knot A gives back S^4 .*

Proof The handlebody of Figure 96 describes the Gluck construction of S^4 along A , which can be equivalently described by Figure 97 (recall Figure 79 ; Figure 82 identification). By introducing a cancelling 1 and 2{handle pair we get Figure 98, and by cancelling 1 and 2{handle pair from Figure 98 we obtain Figure 99.

Now in Figure 100 we introduce a cancelling pair of 2 and 3{handles. In Figure 100 only the new 2{handle m is visible as the zero framed unknotted circle. It is important to check that this new 2{handle is attached along the unknot! (this can be checked by tracing m along the boundary diffeomorphisms Figure 100 ; Figure 101, and Figure 98 ; Figure 97, and Figure 81 ; Figure 78).

In Figure 100 by sliding the +1 framed 2{handle over the 0 framed 2{handle m , we obtain Figure 102. Now comes an important point!: Notice that the 1{handles of Figure 102 are cancelled by 2{handles (ie, through each circle-with-dot there is a framed knot going through geometrically once). So in fact after cancelling 1 and 2{handle pairs, Figure 102 becomes a handlebody consisting of only two 2{handles and two 3{handles. Now, rather than performing these 1 and 2{handle cancellations and drawing the resulting handlebody of 2 and 3{handles, we will turn the handlebody of Figure 102 upside down. This process is performed by taking the dual loops of the 2{handles as in Figure 103 (ie, the small 0{framed circles), and by tracing them under the boundary diffeomorphism from the boundary of the handlebody of Figure 103 to $@(S^1 \times B^3 \# S^1 \times B^3)$, and then by attaching 2{handles to $S^1 \times B^3 \# S^1 \times B^3$ along the images of these dual loops. It is important to note that along this process we are allowed to slide the dual 2{handles over each other and over the other handles.

By a blowing up and down operation, and by isotopies and the indicated handle slides Figure 103 ; Figure 112 we arrive to the handlebody of Figure 112, and by sliding one dual 2{handle over the other one we obtain Figure 113. Now by applying Figure 113 to the boundary diffeomorphism Figure 77 ; Figure 78 we obtain Figure 114 (note that the handlebody of Figure 114 is just $S^1 \times B^3 \# S^1 \times B^3$, it happens to look complicated because of the presence of the dual 2{handles). By sliding the dual 2{handles over each other (as indicated in the figures), and by a blowing up and down operation and isotopies we arrive to Figure 121 which is B^4 . \square

Remark 8 Note that there is an interesting similarities between this proof and the steps Figure 19 ; Figure 29 of [5], which was crucial in showing that the 2-fold covering space of the Cappell-Shaneson's fake \mathbf{RP}^4 is S^4 , [10].

Corollary 9 $\hat{H} = S^3 \quad [0; 1]$

Proof Showing $\hat{H} = S^3 \quad [0; 1]$ is equivalent to showing that the 4-manifold obtained by capping the boundaries of \hat{H} with 4-balls is diffeomorphic to S^4 . Observe that under the 8-fold covering map $\pi : S^3 \rightarrow Q$ the loop C of Figure 122 lifts to a pair of linked Hopf circles in S^3 , each of it covering C four times (this is explained in Figure 123). By replacing C in $\pi(W)$ by the whole strands of 1- and 2-handles going through that middle 1-handle as in Figure 79 (all the handles other than H_1), and by lifting those 1 and 2-handles to S^3 we obtain the 8-fold covering of H , with ends capped off by 4-balls. Since the monodromy π has order 3, each strand has the monodromy $\pi^4 = \pi$. So we need to perform the Gluck construction as in Figure 124, which after handle slides becomes $\# = S^4$ (because we have previously shown that $\pi = S^4$). Note that the bottom two handlebodies of Figure 124 are nothing but S^4 Glucked along A , along with a cancelling pair of 2 and 3-handles (as usual in this pair the 2-handle is attached to the unknot on the boundary, ie, the horizontal zero-framed circle, and the 3-handle is not drawn). \square

Corollary 10 $\hat{W}_+ = \hat{W}$

Proof By inspecting the 2-fold covering map in Figure 123, and by observing that $\pi^2 = \pi^{-1}$ we get the handlebody of \hat{W}_+ in Figure 125. As before, since the -4 framed handle is attached along the trivial loop on the boundary we get $\hat{W}_+ = \hat{W} \# \pi$, where π is the S^4 Glucked along A (recall the previous Corollary), hence we have $\hat{W}_+ = \hat{W} = \text{Euler class } -4 \text{ disk bundle over } S^2 \quad \square$

Remark 11 An amusing fact: It is not hard to check that the 2-knot complement Y is obtained by the 0-logarithmic transformation operation performed along an imbedded Klein bottle \mathbf{K} in $\hat{M} - S^1 \times B^3$ (which is \hat{M} minus a 3-handle) ie, in Figure 21. This is done by first changing the 1-handle notation of Figure 21 (by using the arcs in Figure 126) to circle-with-dot notation, then by simply exchanging a dot with the zero framing as indicated by the first picture of Figure 127. The result is the second picture of Figure 127 which is Y . This operation is nothing other than removing the tubular neighborhood N of \mathbf{K} from $\hat{M} - S^1 \times B^3$ and putting it back by a diffeomorphism which is the

obvious involution on the boundary. It is also easy to check that by performing yet another logarithmic transformation operation to Y along an imbedded \mathbf{K} gives $S^1 \times B^3$ (this is Figure 77) Figure 78). So the operations

$$S^1 \times B^3 \rightarrow Y \rightarrow \hat{M} \rightarrow S^1 \times B^3$$

are nothing but logarithmic transforms along \mathbf{K} . Note that all of the 4 manifolds $S^1 \times B^3$, Y and M are bundles over S^1 , with fibers B^3 , Q_0 , and $T_0 \rightarrow S^1$ respectively.

Remark 12 Recall [12] that a knot $\Sigma^{n-2} \subset S^n$ is said to admit a strong \mathbf{Z}_m action if there is a diffeomorphism $h: S^n \rightarrow S^n$ with

- (i) $h^m = 1$
- (ii) $h(x) = x$ for every $x \in \Sigma^{n-2}$
- (iii) $x; h(x); h^2(x); \dots; h^{m-1}(x)$ are all distinct for every $x \in S^n - \Sigma^{n-2}$

By the proof of the Smith conjecture when $n = 3$ the only knot that admits a strong \mathbf{Z}_m action is the unknot. For $n = 4$ in [11] Gi en found knots that admit strong \mathbf{Z}_m actions when m is odd. Our knot $A \subset S^4$ provides an example of knot which admits a strong \mathbf{Z}_m action for $m \not\equiv 0 \pmod 3$. This follows from Proposition 7, and from the fact that A is a fibered knot with an order 3 monodromy.

Remark 13 Recall the vertical picture of H in Figure 77, appearing as $W_+ \rightarrow W$. We can place H vertically on top of $Q \rightarrow I$ (Figure 4) by identifying Q_+ with $Q \rightarrow I$

$$Z := H \wedge_{Q_+} (Q \rightarrow I)$$

Resulting handlebody of Z is Figure 128. As a smooth manifold Z is nothing other than a copy of H . So Figure 128 provides an alternative handlebody picture of H (the other one being Figure 47).

Remark 14 Let X^4 be a smooth 4-manifold, and $C \subset X^4$ be any loop with the property that $[C] \in \pi_1(X)$ is a torsion element of order $\equiv 1 \pmod 3$, and $U \subset S^1 \times B^3$ be the open tubular neighborhood of C . We can form:

$$\hat{X} := (X - U) \wedge_{\partial U} Y$$

Recall that $\pi_1(Y) = \langle ht; ajt^3 = a^3; ata = tati \rangle$, so by Van-Kampen theorem we get $\pi_1(\hat{X}) = \pi_1(X)$, in fact \hat{X} is homotopy equivalent to X . In particular by applying this process to $X = M^3 \rightarrow I$, where M^3 is a 3-manifold whose fundamental group contains a torsion element of order $\equiv 1 \pmod 3$, we can construct many examples of potentially nontrivial cobordisms \hat{X} from M to itself.

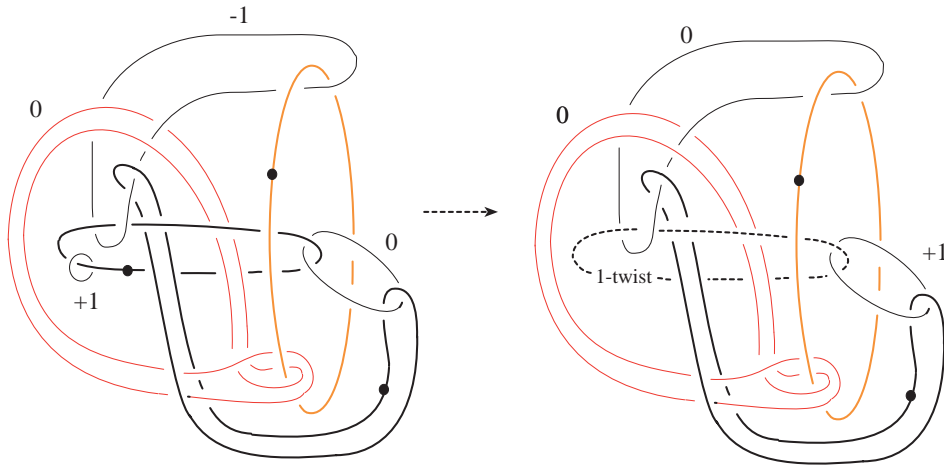

Figure 98

Figure 99

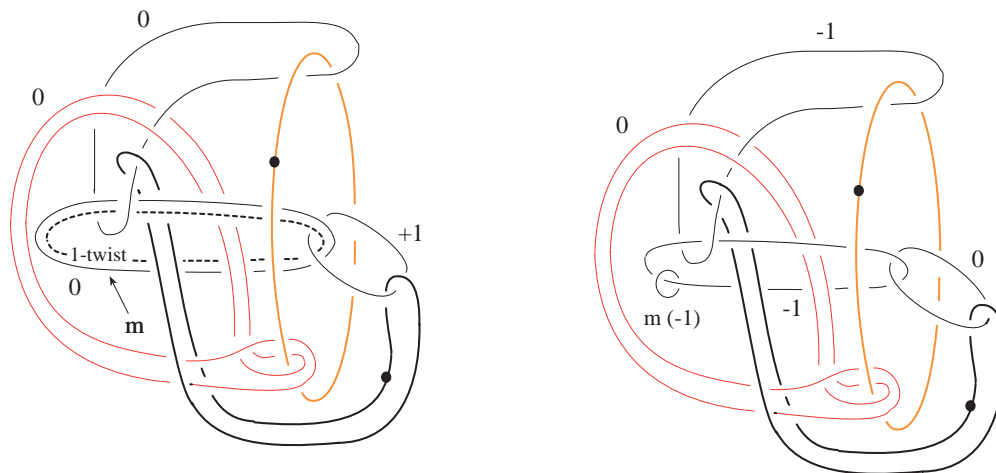

Figure 100

Figure 101

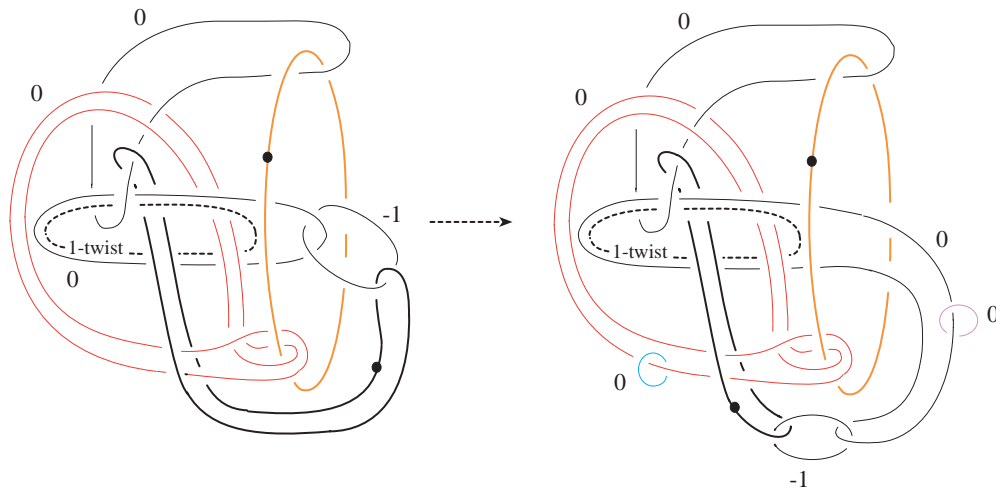

Figure 102

Figure 103

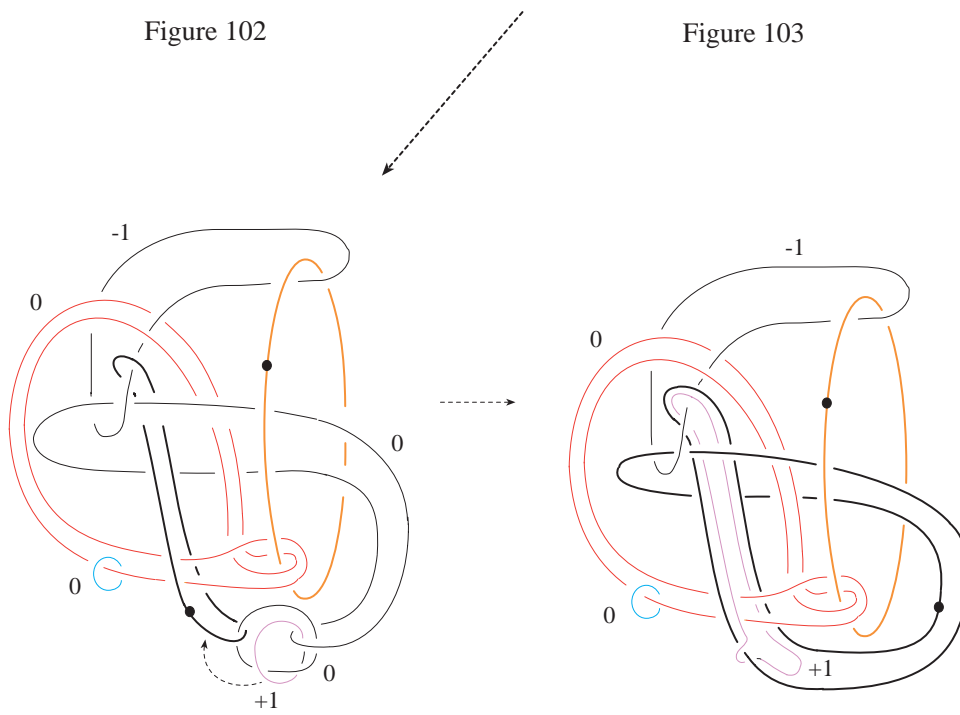

Figure 104

Figure 105

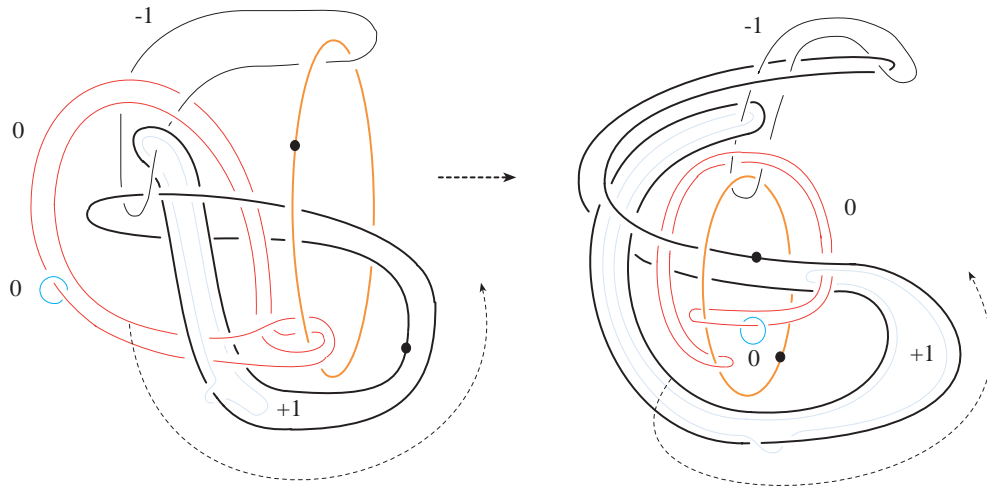

Figure 106

Figure 107

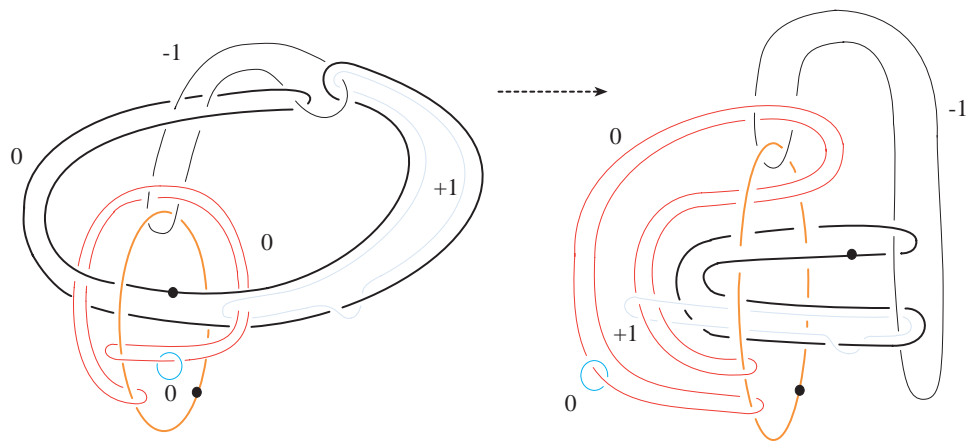

Figure 108

Figure 109

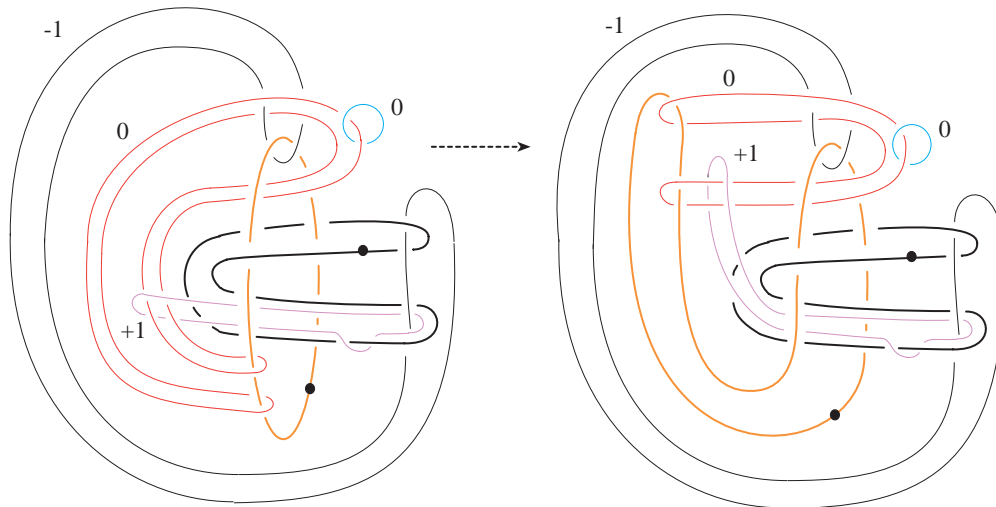

Figure 110

Figure 111

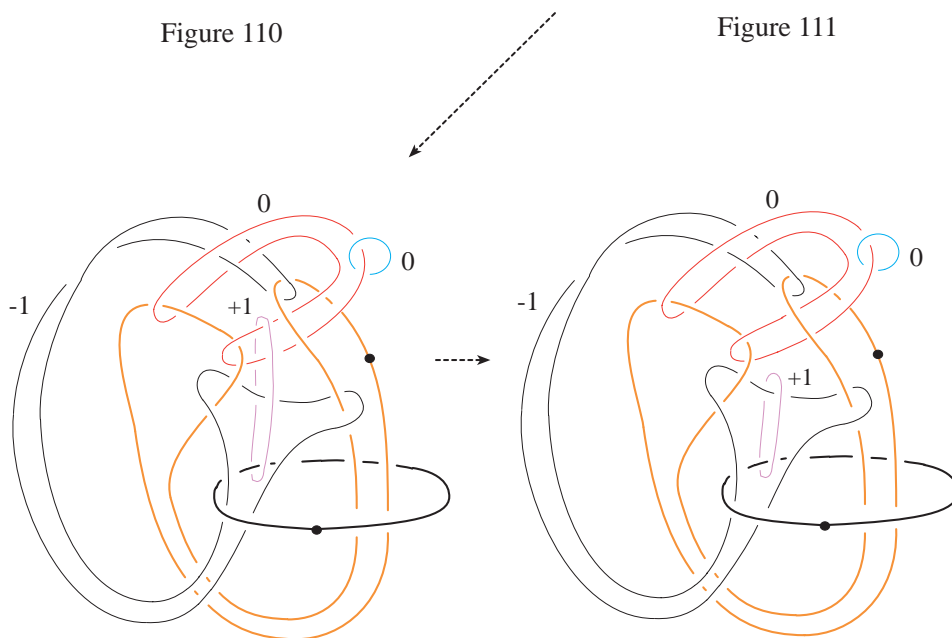

Figure 112

Figure 113

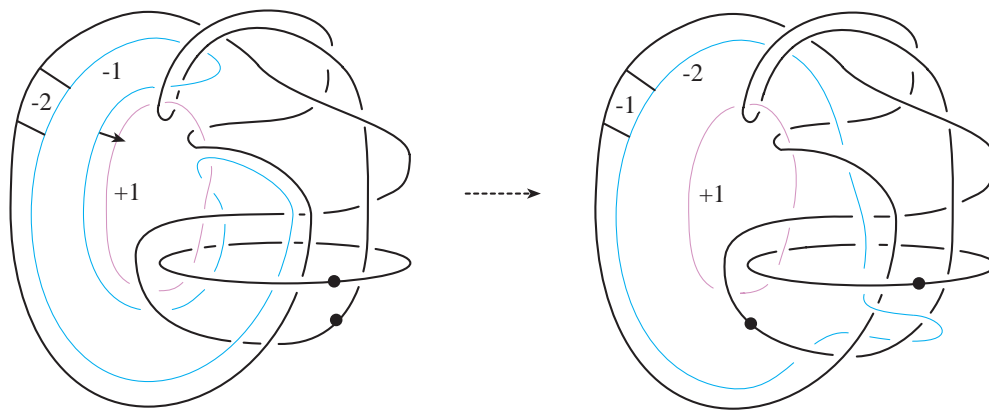

Figure 114

Figure 115

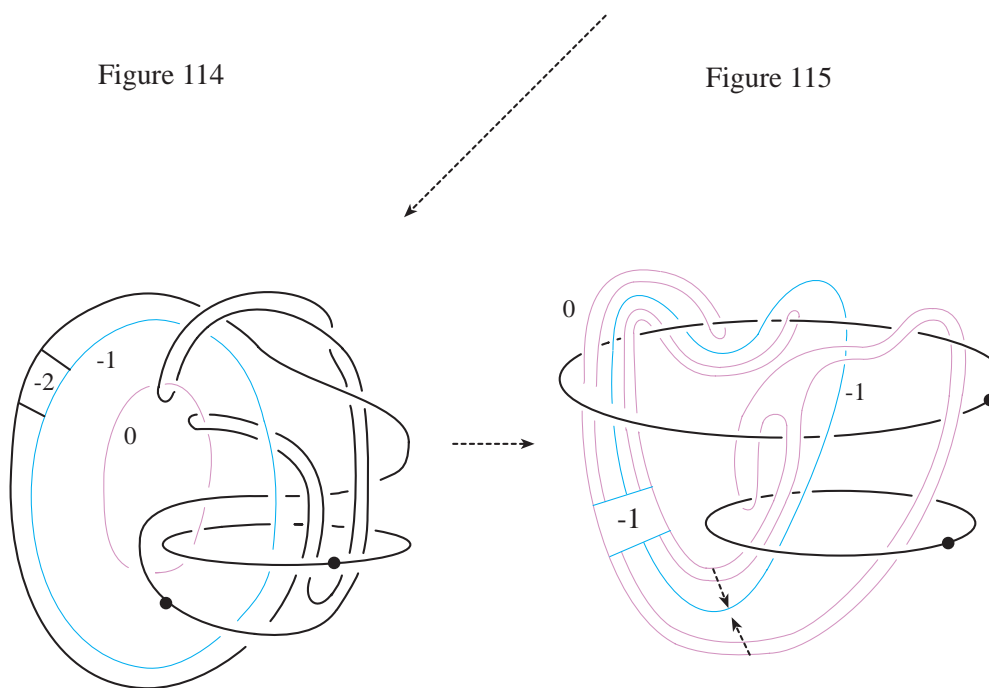

Figure 116

Figure 117

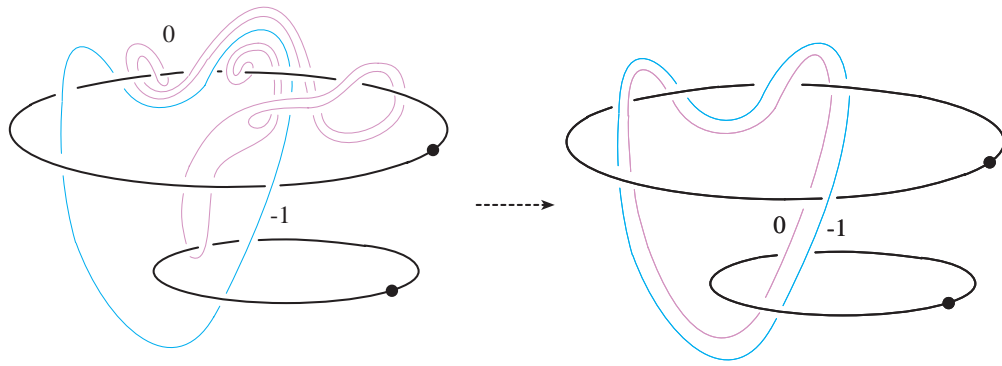

Figure 118

Figure 119

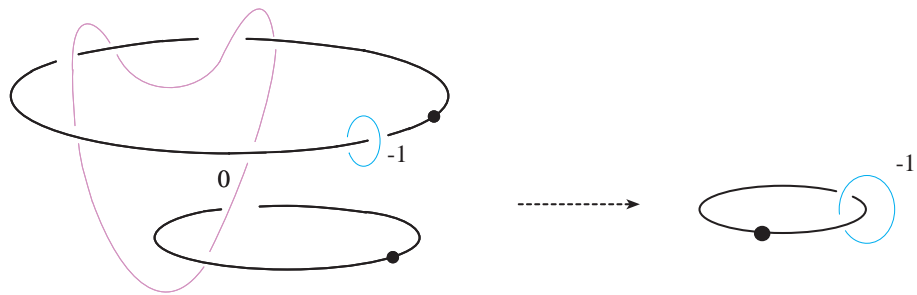

Figure 120

Figure 121

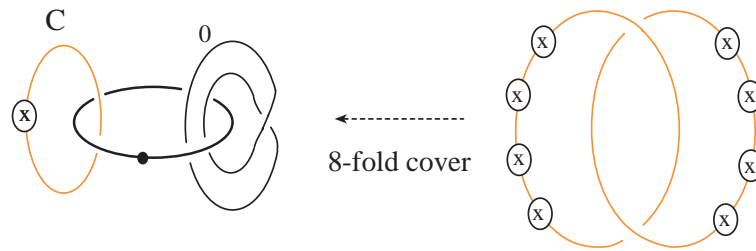

Figure 122

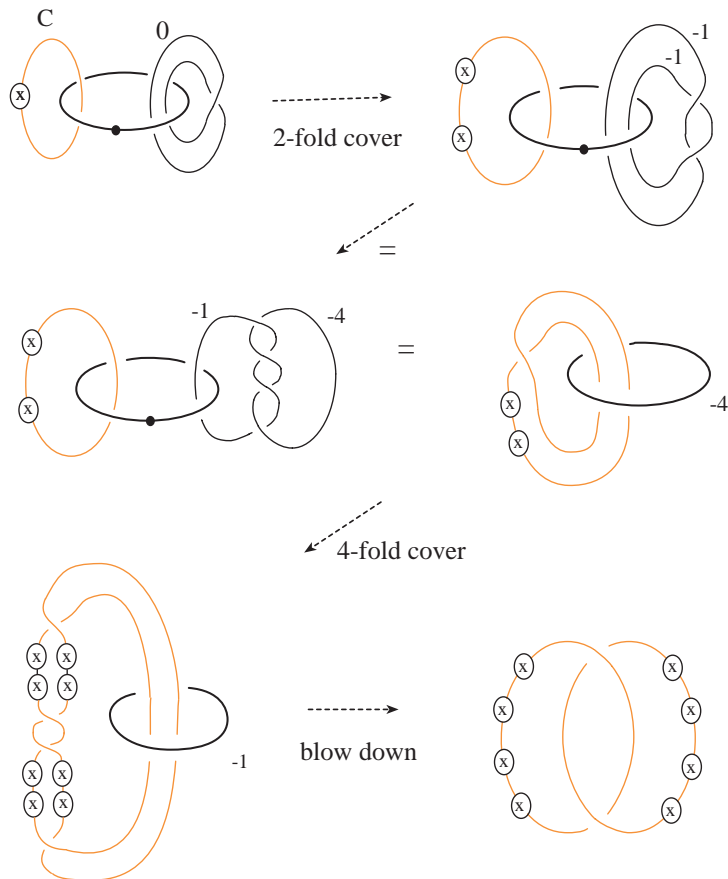

Figure 123

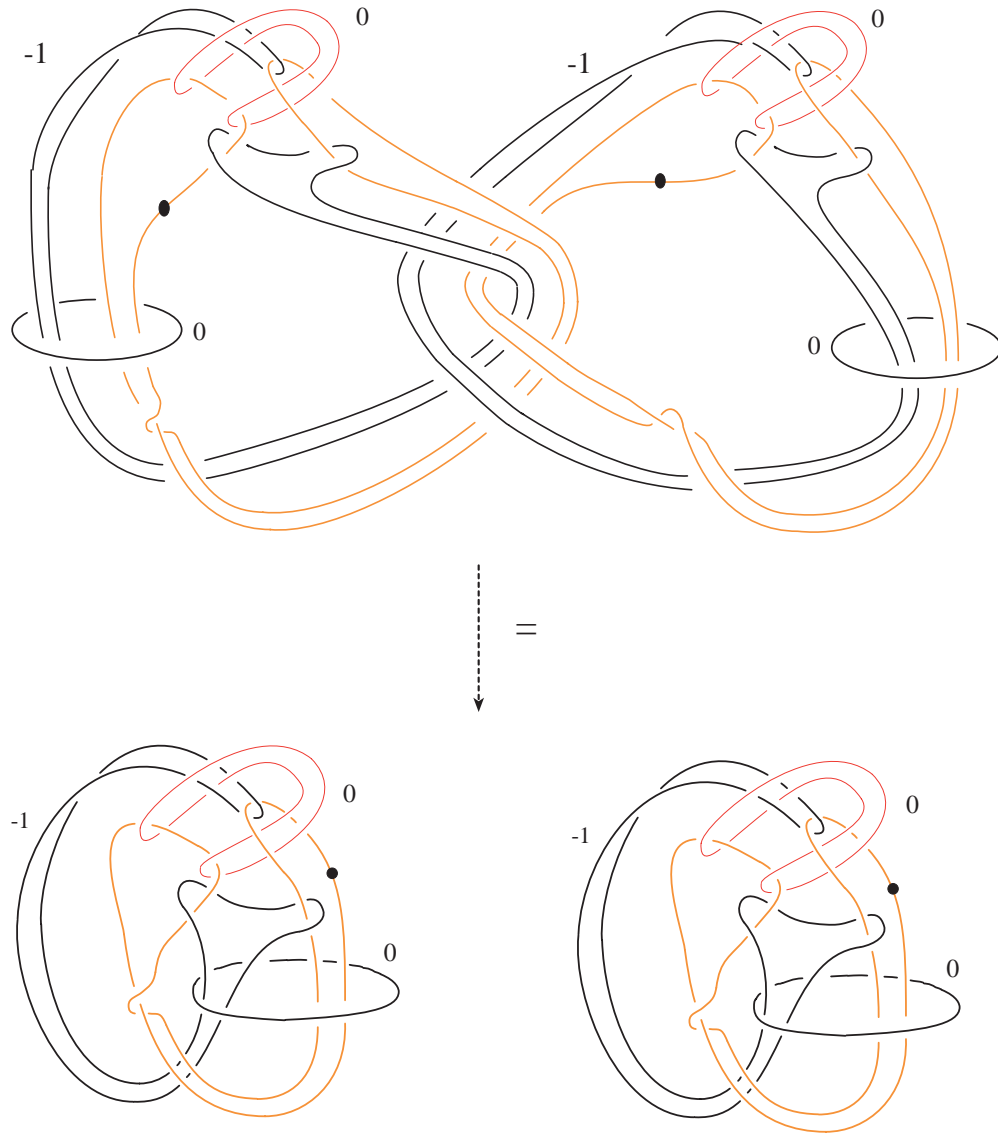

Figure 124

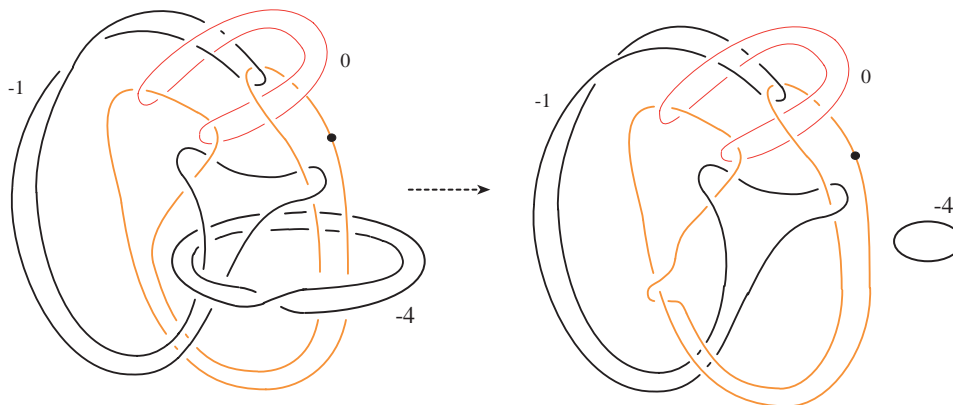

Figure 125

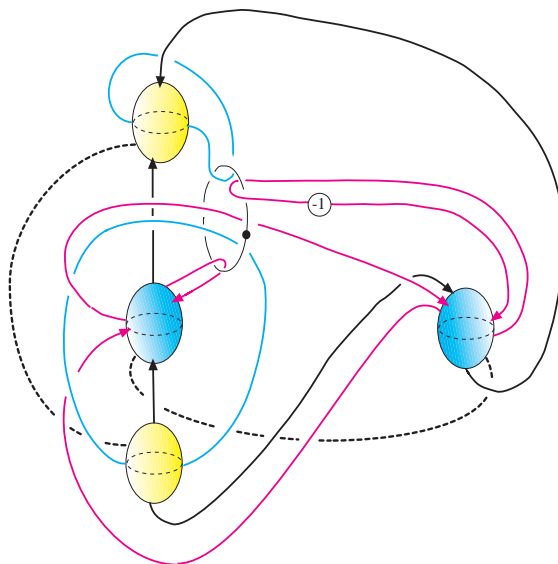

Figure 126

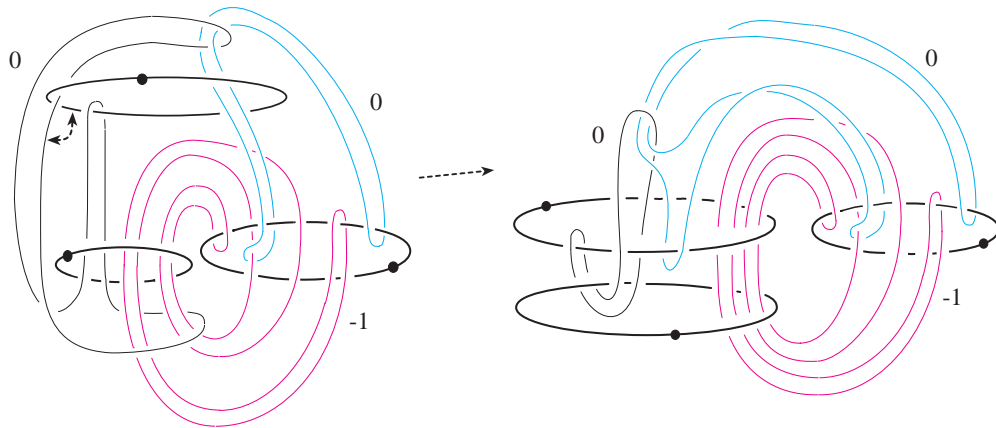

Figure 127

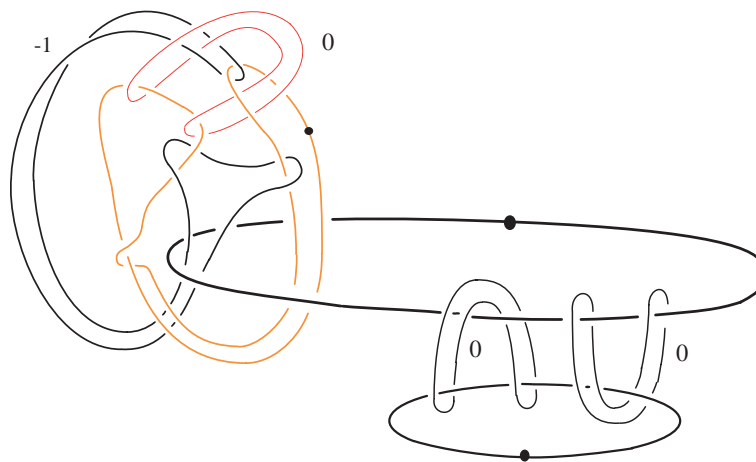

Figure 128

12 More on A

In this section we will give even a simpler and more concrete description of the 2-knot A . As a corollary we will show that W_+ is obtained from W by performing the Fintushel-Stern knot surgery operation by using the trefoil knot K ([8]). It is easy to check that Figure 129, which describes A (recall Figure 82), is isotopic to Figure 130. To reduce the clutter, starting with Figure 130 we will denote the small 0-framed circle, which links A twice, by a single thick circle \bullet .

By performing the indicated handle slide to the handlebody of Figure 130 we arrive to Figure 131, which can be drawn as Figure 132. By introducing a cancelling pair of 1 and 2-handles to the handlebody of Figure 132, then sliding them over other handles, and again cancelling that handle pair we get Figure 133 (this move is self explanatory from the figures). Then by an isotopy we get Figure 134, by the indicated handle slide we arrive to Figure 135. By drawing the "slice 1-handle" (see [2]) as a 1-handle and a pair of 2-handles we get the diffeomorphism Figure 135 ; Figure 136, and a further handle slide gives Figure 137, which is an alternative picture of the 2-knot complement A . The reader can check that the boundary of Figure 137 is standard by the boundary diffeomorphism Figure 137 ; Figure 138, which consists of a blowing-up + handle sliding + blowing-down operations (done three times).

A close inspection reveals that the handlebody of the 2-knot complement A in Figure 135 is the same as Figure 139. Figure 139 gives another convenient way of checking that the boundary of this handlebody is standard (eg, remove the dot from the slice 1-handle and perform blowing up and sliding and blowing down operations, three times, as indicated by the dotted lines of Figure 140). Now we can also trace the loop \bullet into Figure 140, so Figure 140 becomes handlebody of W_+ . By drawing the slice 1-handle as a 1-handle and a pair of 2-handles we get a diffeomorphism Figure 140 ; Figure 141. Clearly Figure 142 is diffeomorphic to Figure 141. Now by introducing a cancelling pair of 2 and 3-handles we obtain the diffeomorphism Figure 142 ; Figure 143 (it is easy to check that the new 2-handle of Figure 143 is attached along the unknot on the boundary).

Now, let us recall the Fintushel-Stern knot surgery operation [8]: Let X be a smooth 4-manifold containing an imbedded torus T^2 with trivial normal bundle, and $K \subset S^3$ be a knot. The operation $\mathbf{X} ; \mathbf{X}_K$ of replacing a tubular neighborhood of T^2 in X by $(S^3 - K) \times S^1$ is the so called Fintushel-Stern knot surgery operation. In [1] and [3] an algorithm of describing the handlebody of

X_K in terms of the handlebody of X is given. From this algorithm we see that Figure 144 ; Figure 143 is exactly the operation $W ; W_K$ where K is the trefoil knot. And also it is easy to check that Figure 144 ; Figure 145 describes a diffeomorphism to W . Hence we have proved:

Proposition 15 W_+ is obtained from W by the Fintushel{Stern knot surgery operation along an imbedded torus by using the trefoil knot K

Remark 16 Note that we in fact proved that the knot complement $S^4 - A$ is obtained by from $S^1 \times B^3$ by the Fintushel{Stern knot surgery operation along an imbedded torus by using the trefoil knot K . Unfortunately this torus is homologically trivial; if it wasn't, from [8], we could have concluded that W_+ (hence H) is exotic.

Remark 17 Now it is evident from From Figure 139 that A is the 3{twist spun of the trefoil knot ([16]). This explains why A is the braid knot with braid Q (which is the 3{fold branched cover of the trefoil knot). After this paper was written, we were pointed out that in [13] it had proven that the Gluck construction to a twist-spun knot gives back S^4 . So in hind-sight we could have delayed the Proposition 7 until this point and deduce its proof from [13], but this would have altered the natural evolution of the paper. Our hands-on proof of Proposition 7 should be seen as a part a general technique which had been previously utilized in [2], [5].

Finally, note that if A_n is the n {twist spun of the trefoil knot (Figure 146), then one can check that its fundamental group generalizes the presentation of A :

$$G_n = \langle ht; a ja = t^{-n}at^n; ata = tati = ht; a jt^n = a^n; ata = tati \rangle$$

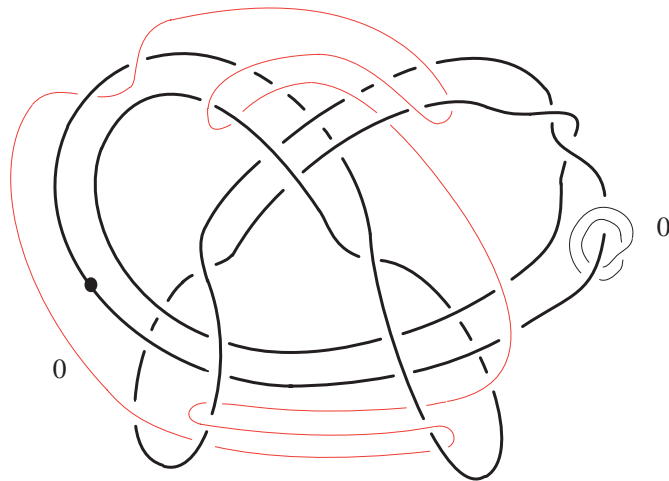

Figure 129

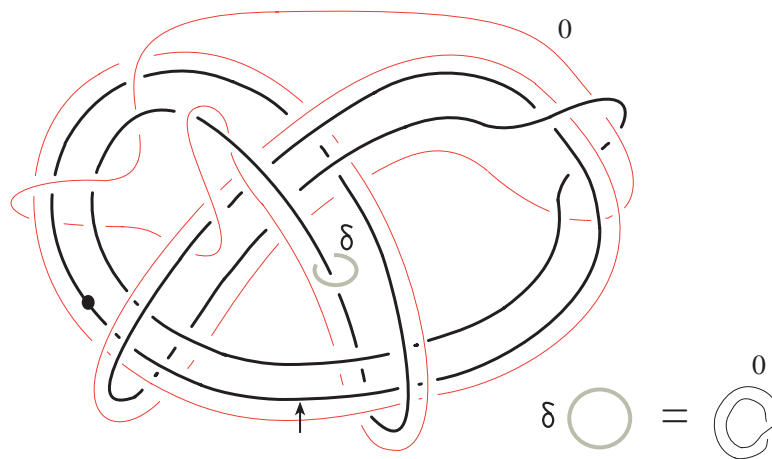

Figure 130

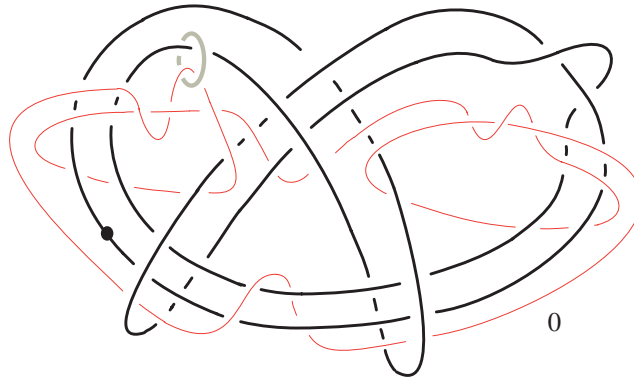

Figure 131

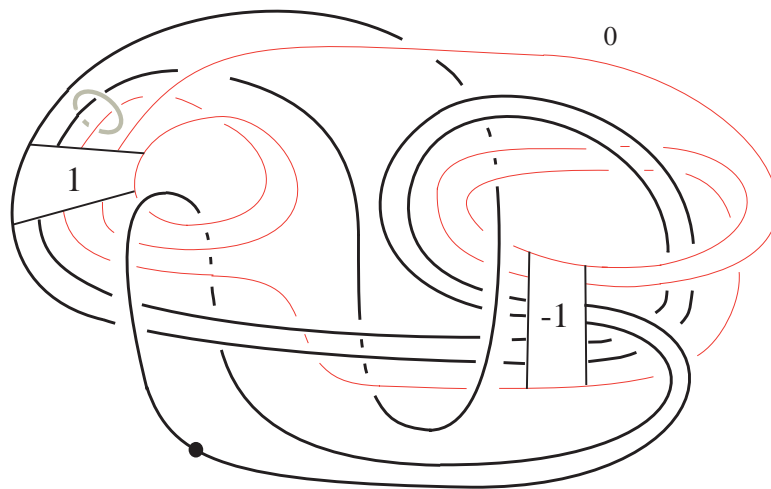

Figure 132

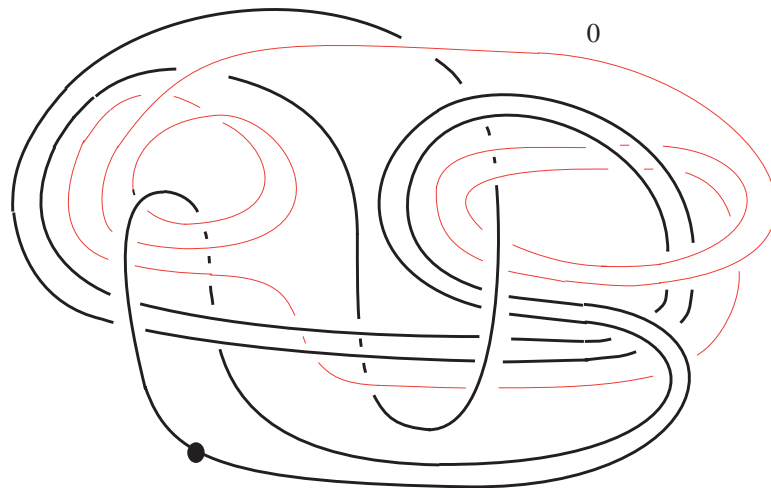

Figure 133

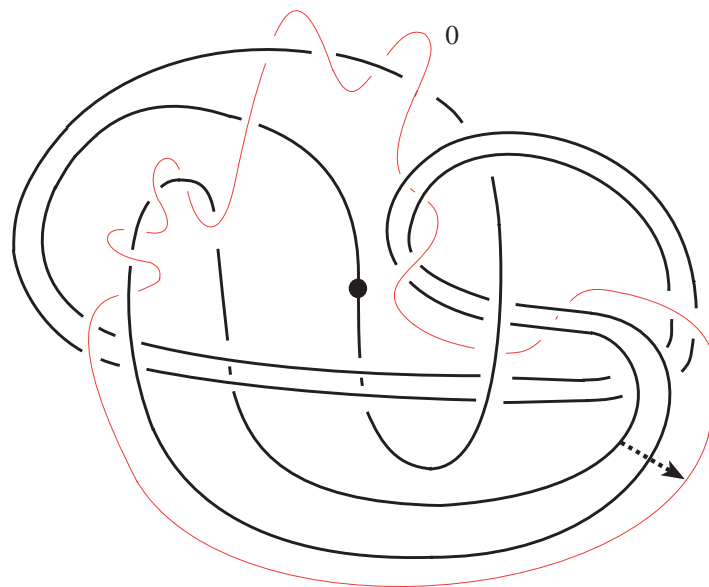

Figure 134

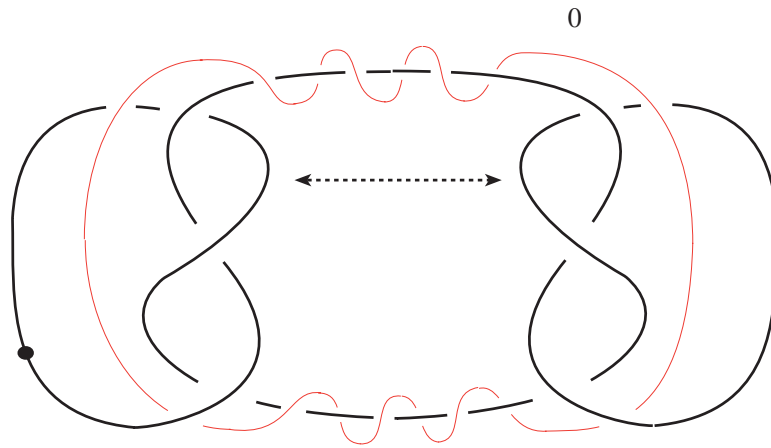

Figure 135

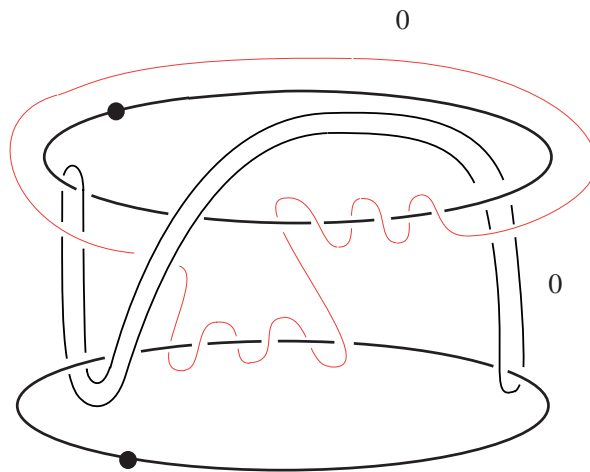

Figure 136

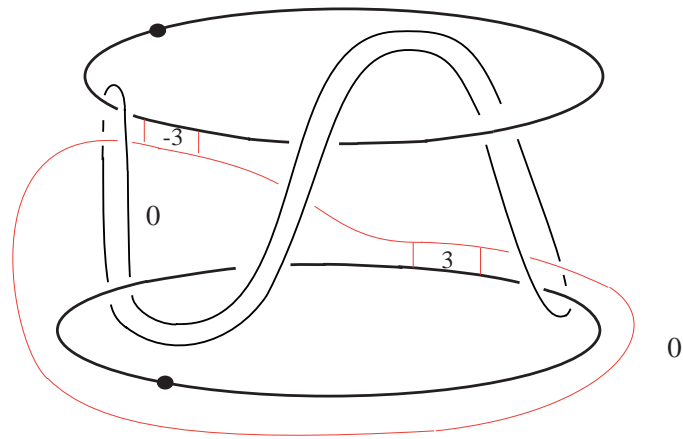

Figure 137

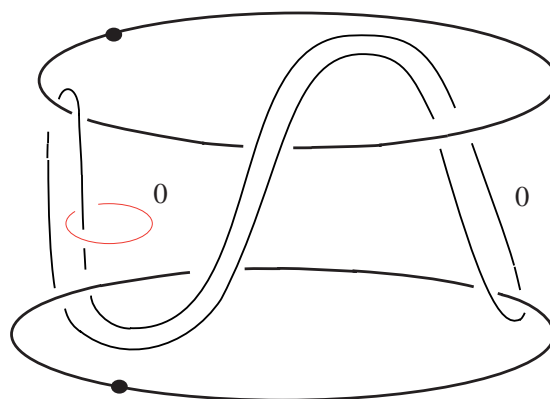

Figure 138

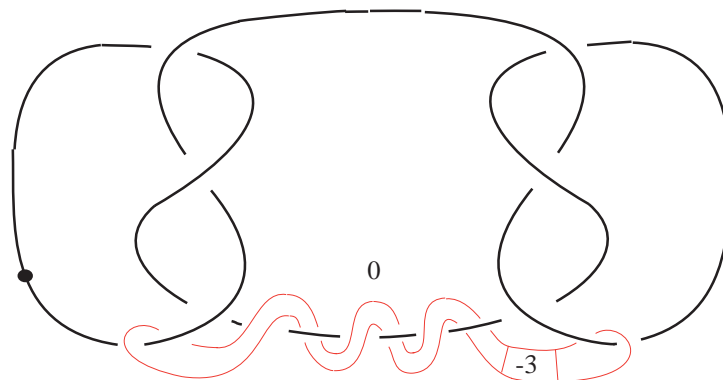

Figure 139

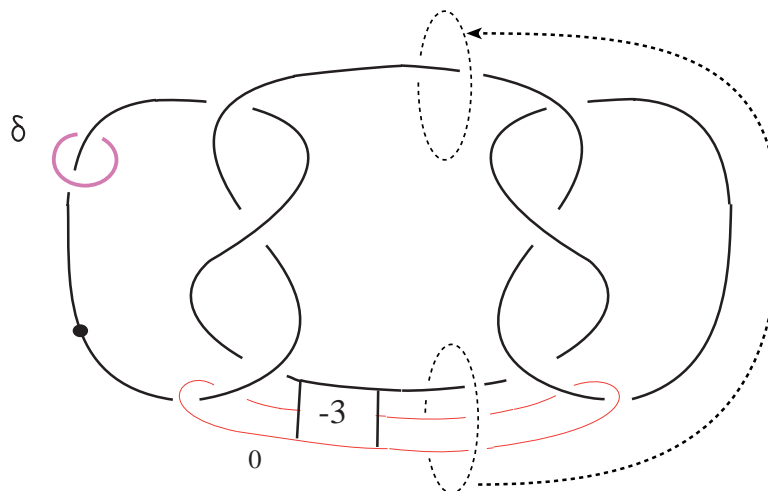

Figure 140

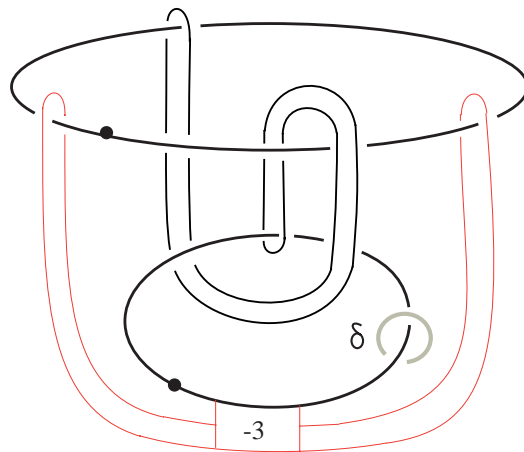

Figure 141

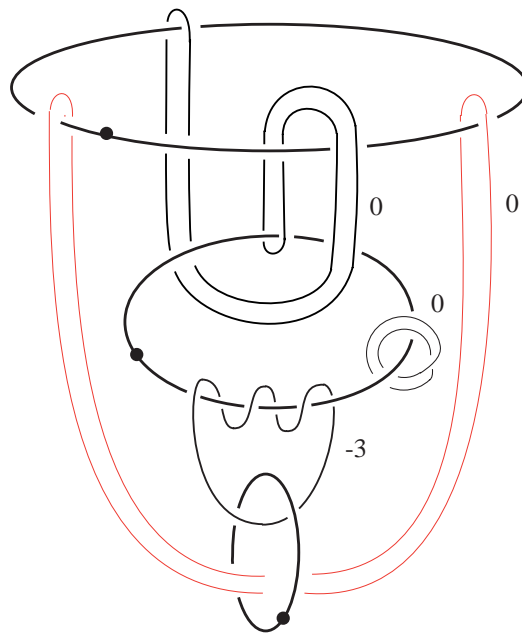

Figure 142

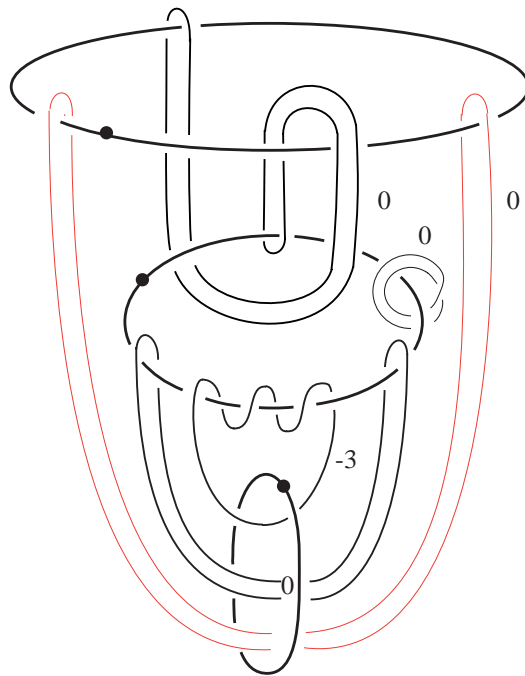

Figure 143

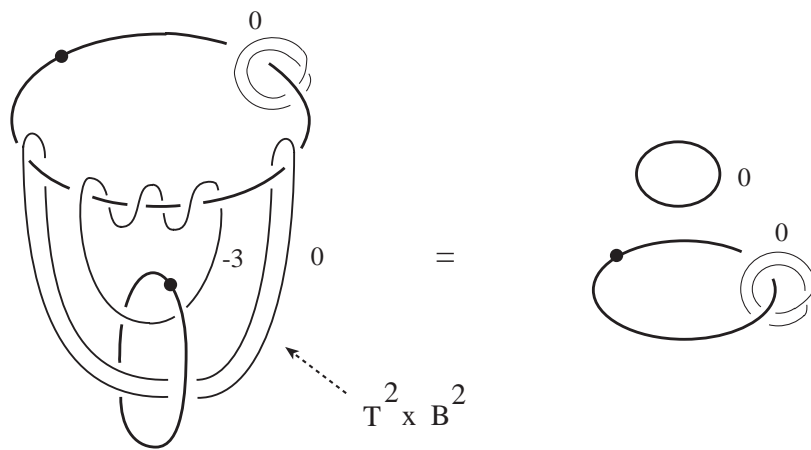

Figure 144

Figure 145

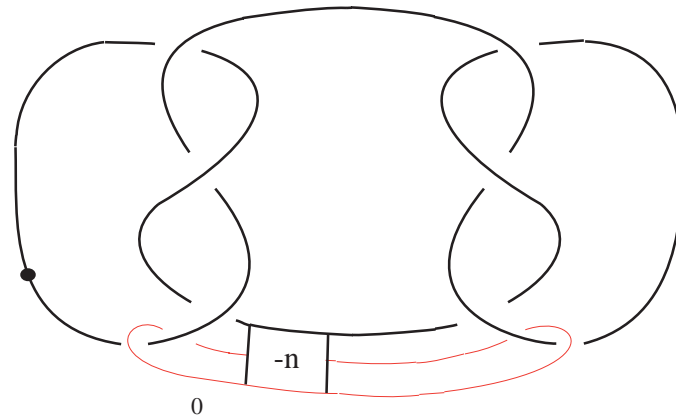

Figure 146

References

- [1] **S Akbulut**, *A fake cusp and a shtail*, Turkish Journal of Math. 23 (1999) 19{31, arXiv: math. GT/9904058
- [2] **S Akbulut**, *Scharlemann's manifold is standard*, Ann. of Math. 149 (1999) 497{510.
- [3] **S Akbulut**, *Variations on Fintushel{Stern knot surgery on 4{manifolds*, Proceedings of 8th Gokova Geometry{Topology Conf. (2001) 81{92, arXiv: math. GT/0201156
- [4] **S Akbulut**, **R Kirby**, *An exotic involution of S^4* , Topology, 18 (1979) 75{81
- [5] **S Akbulut**, **R Kirby**, *A potential smooth counterexample in dimension 4 to the Poincare conjecture, the Andrews{Curtis conjecture*, Topology, 24 (1985) 375{390
- [6] **S E Cappell**, **J L Shaneson**, *Smooth nontrivial 4{dimensional s -cobordisms*, Bull. Amer. Math.Soc. 17 (1987) 141{143.
- [7] **S E Cappell**, **J L Shaneson**, *Corrigendum to: Smooth nontrivial 4{dimensional s -cobordisms*, Bull. Amer. Math. Soc. 17 (1987) 401
- [8] **R Fintushel**, **R Stern**, *Knots, links, and 4{manifolds*, Inv. Math. 134 (1998) 363{400.
- [9] **R Gompf**, *Handlebody construction of Stein surfaces*, Ann. of Math. 148 (1998) 619{693

- [10] **R Gompf**, *Killing the Akbulut-Kirby 4-sphere, with relevance to the Andrews-Curtis and Schoenflies problems*, *Topology*, 30 (1991) 97-115
- [11] **CH Gi en**, *The Generalized Smith Conjecture*, *Amer. J. Math.* 88 (1966) 187-198
- [12] **CM Gordon**, *On the Higher-Dimensional Smith Conjecture*, *Proc. London Math. Soc.* 29 (1974) 98-110
- [13] **CM Gordon**, *Knots in the 4-sphere*, *Comm. Math. Helv.* 51 (1976) 585-596
- [14] **U Meierfrankenfeld**, *(Private communications)*
- [15] **T Price**, *Homeomorphisms of quaternion space and projective planes in four space*, *J. Austral. Math. Soc.* 23 (1977) 112-128
- [16] **EC Zeeman**, *Twisting spun knots*, *Trans. Amer. Math. Soc.* 115 (1965) 471-495